

# Computer Graphics (CS 543)

## Lecture 7 (Part 1): Shadows and Fog

---

Prof Emmanuel Agu

*Computer Science Dept.  
Worcester Polytechnic Institute (WPI)*

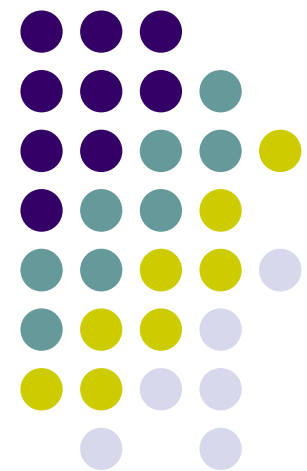



# Introduction to Shadows

- Shadows give information on relative positions of objects

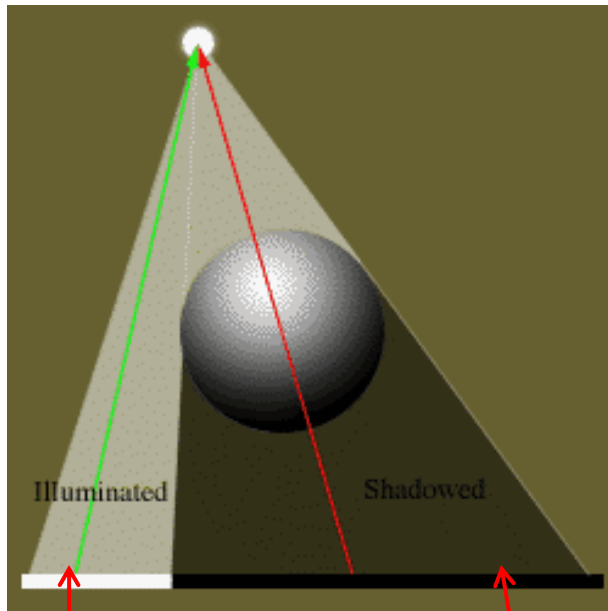

Use ambient +  
diffuse + specular  
components

Use just ambient  
component

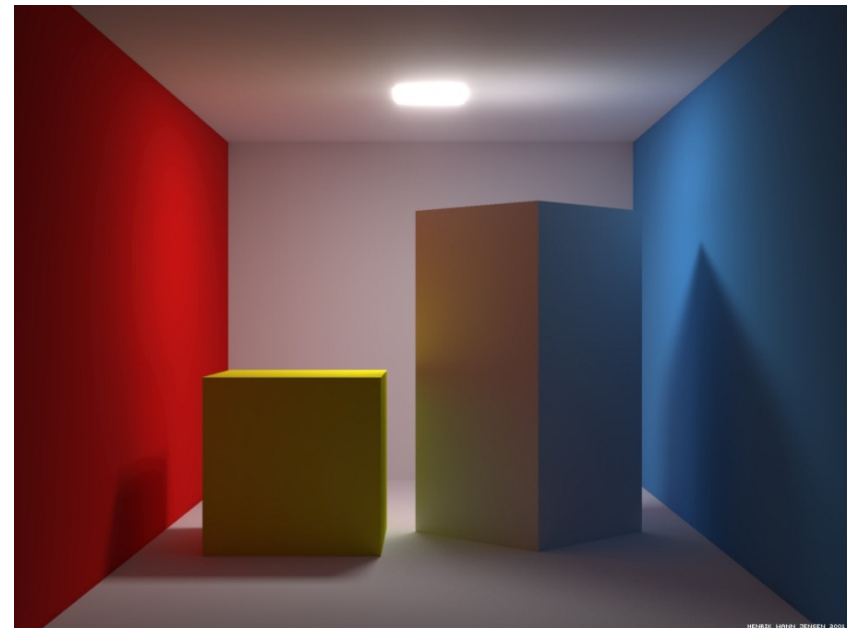



# Introduction to Shadows

- Two popular shadow rendering methods:
  1. Shadows as texture (projection)
  2. Shadow buffer
- Third method used in ray-tracing (covered later)



# Projective Shadows

- Oldest method: Used in early flight simulators
- Projection of polygon is polygon called **shadow polygon**

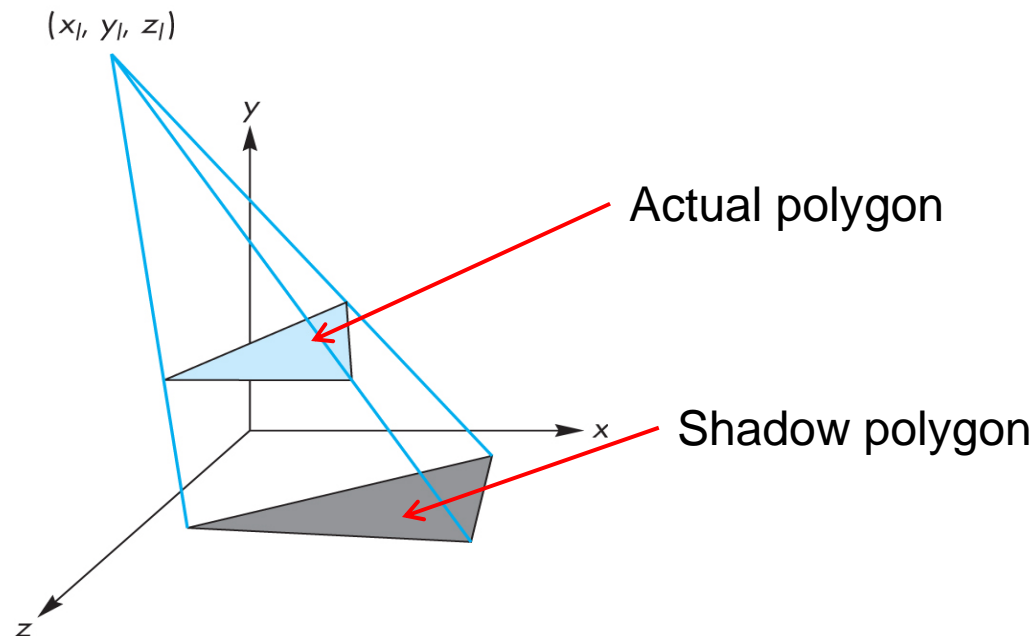



# Projective Shadows

- Works for flat surfaces illuminated by point light
- For each face, project vertices  $\mathbf{V}$  to find  $\mathbf{V}'$  of shadow polygon
- Object shadow = union of projections of faces

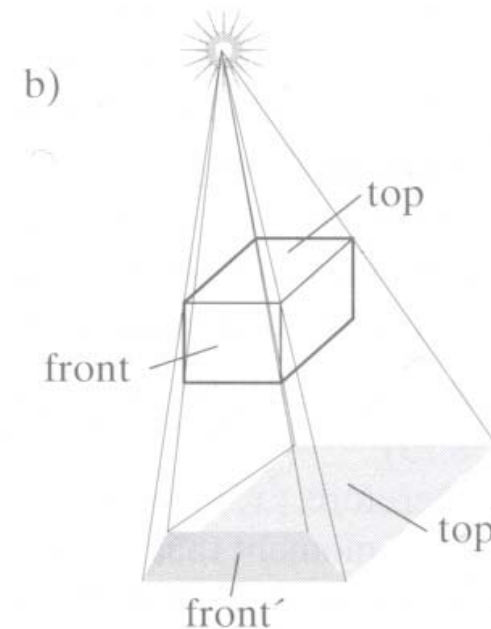
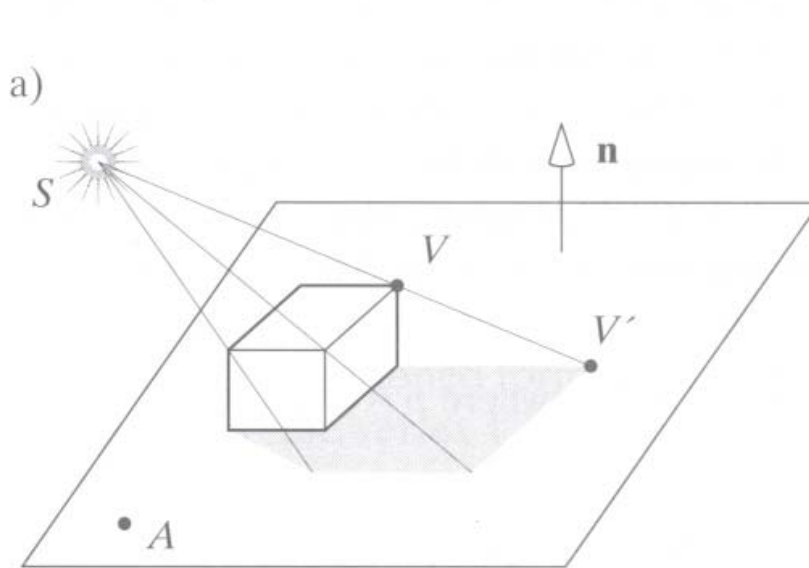



# Projective Shadow Algorithm

- Project light-object edges onto plane
- Algorithm:
  - First, draw ground plane using specular+diffuse+ambient components
  - Then, draw shadow projections (face by face) using only ambient component



# Projective Shadows for Polygon

1. If light is at  $(x_l, y_l, z_l)$
2. Vertex at  $(x, y, z)$
3. Would like to calculate shadow polygon vertex  $V$  projected onto ground at  $(x_p, 0, z_p)$

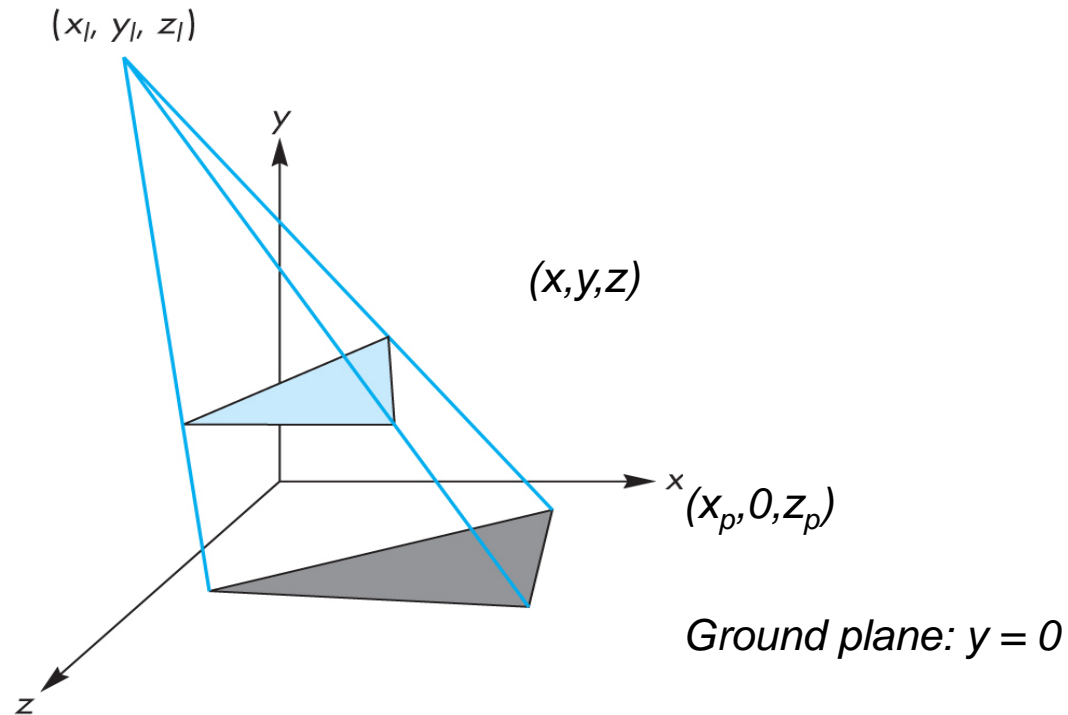



# Projective Shadows for Polygon

- If we move original polygon so that light source is at origin
- Matrix  $M$  projects a vertex  $V$  to give its projection  $V'$  in shadow polygon

$$M = \begin{bmatrix} 1 & 0 & 0 & 0 \\ 0 & 1 & 0 & 0 \\ 0 & 0 & 1 & 0 \\ 0 & \frac{1}{-y_l} & 0 & 0 \end{bmatrix}$$

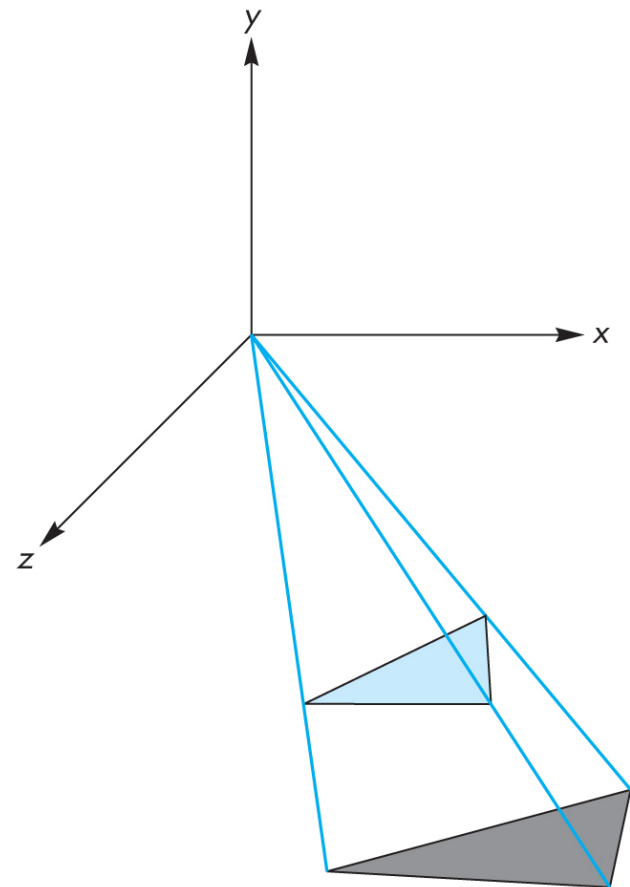





# Building Shadow Projection Matrix

1. Translate source to origin with  $T(-x_l, -y_l, -z_l)$
2. Perspective projection
3. Translate back by  $T(x_l, y_l, z_l)$

$$M = \begin{bmatrix} 1 & 0 & 0 & x_l \\ 0 & 1 & 0 & y_l \\ 0 & 0 & 1 & z_l \\ 0 & 0 & 0 & 1 \end{bmatrix} \begin{bmatrix} 1 & 0 & 0 & 0 \\ 0 & 1 & 0 & 0 \\ 0 & 0 & 1 & 0 \\ 0 & \frac{1}{-y_l} & 0 & 0 \end{bmatrix} \begin{bmatrix} 1 & 0 & 0 & -x_l \\ 0 & 1 & 0 & -y_l \\ 0 & 0 & 1 & -z_l \\ 0 & 0 & 0 & 1 \end{bmatrix}$$

Final matrix that projects  
Vertex  $V$  onto  $V'$  in shadow polygon



# Code snippets?

- Set up projection matrix in OpenGL application

```
float light[3]; // location of light
mat4 m; // shadow projection matrix initially identity
```

```
M[3][1] = -1.0/light[1];
```

$$M = \begin{bmatrix} 1 & 0 & 0 & 0 \\ 0 & 1 & 0 & 0 \\ 0 & 0 & 1 & 0 \\ 0 & \frac{1}{-y_l} & 0 & 0 \end{bmatrix}$$



# Projective Shadow Code

- Set up object (e.g a square) to be drawn

```
point4 square[4] = {vec4(-0.5, 0.5, -0.5, 1.0)}  
                  {vec4(-0.5, 0.5, -0.5, 1.0)}  
                  {vec4(-0.5, 0.5, -0.5, 1.0)}  
                  {vec4(-0.5, 0.5, -0.5, 1.0)}
```

- Copy square to VBO
- Pass modelview, projection matrices to vertex shader



# What next?

- Next, we load `model_view` as usual then draw original polygon
- Then load shadow projection matrix, change color to black, re-render polygon

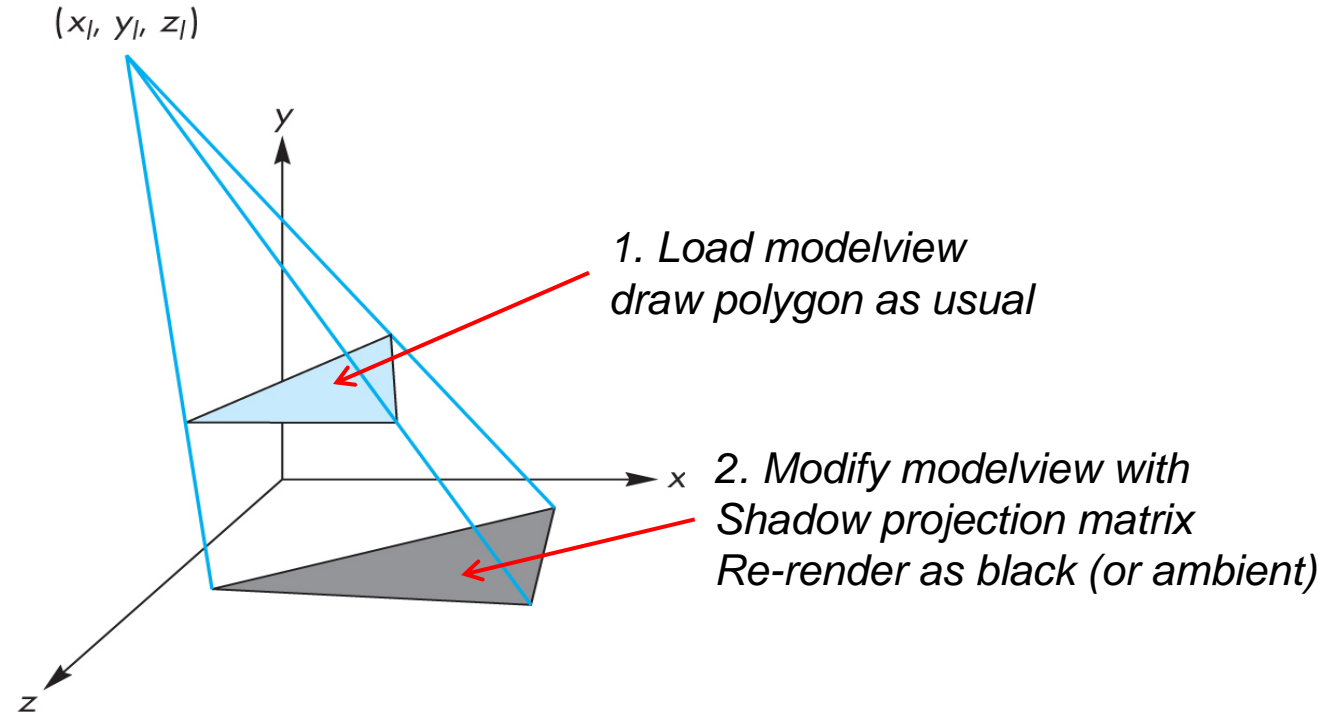

# Shadow projection Display( ) Function



```
void display( )
{
    mat4 mm;
    // clear the window
    glClear(GL_COLOR_BUFFER_BIT | GL_DEPTH_BUFFER_BIT);

    // render red square (original square) using modelview
    // matrix as usual (previously set up)
    glUniform4fv(color_loc, 1, red);
    glDrawArrays(GL_TRIANGLE_STRIP, 0, 4);
}
```



# Shadow projection Display( ) Function

```
// modify modelview matrix to project square
// and send modified model_view matrix to shader
mm = model_view
    * Translate(light[0], light[1], light[2])
    *m
    * Translate(-light[0], -light[1], -light[2]);
glUniformMatrix4fv(matrix_loc, 1, GL_TRUE, mm);

//and re-render square as
// black square (or using only ambient component)
glUniform4fv(color_loc, 1, black);
glDrawArrays(GL_TRIANGLE_STRIP, 0, 4);
glutSwapBuffers( );
}
```

$$M = \begin{bmatrix} 1 & 0 & 0 & x_l \\ 0 & 1 & 0 & y_l \\ 0 & 0 & 1 & z_l \\ 0 & 0 & 0 & 1 \end{bmatrix} \begin{bmatrix} 1 & 0 & 0 & 0 \\ 0 & 1 & 0 & 0 \\ 0 & 0 & 1 & 0 \\ 0 & \frac{1}{-y_l} & 0 & 0 \end{bmatrix} \begin{bmatrix} 1 & 0 & 0 & -x_l \\ 0 & 1 & 0 & -y_l \\ 0 & 0 & 1 & -z_l \\ 0 & 0 & 0 & 1 \end{bmatrix}$$



# Shadow Buffer Approach

- Uses second **depth buffer** called shadow buffer
- Pros: not limited to plane surfaces
- Cons: needs lots of memory
- Depth buffer?



# OpenGL Depth Buffer (Z Buffer)

- **Depth:** While drawing objects, depth buffer stores distance of each polygon from viewer
- **Why?** If multiple polygons overlap a pixel, only closest one polygon is drawn

1.0	1.0	1.0	1.0
1.0	0.3	0.3	1.0
0.5	0.3	0.3	1.0
0.5	0.5	1.0	1.0

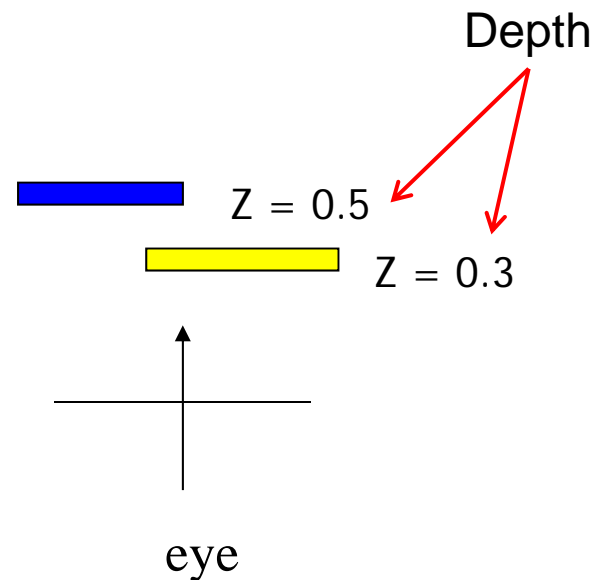





# Setting up OpenGL Depth Buffer

- **Note:** You did this in order to draw solid cube, meshes
  1. `glutInitDisplayMode(GLUT_DEPTH | GLUT_RGB)`  
instructs OpenGL to create depth buffer
  2. `glEnable(GL_DEPTH_TEST)` enables depth testing
  3. `glClear(GL_COLOR_BUFFER_BIT | GL_DEPTH_BUFFER_BIT)`  
Initializes depth buffer every time we draw a new picture



# Shadow Buffer Theory

- Along each path from light
  - Only closest object is lit
  - Other objects on that path in shadow
- Shadow buffer stores closest object on each path

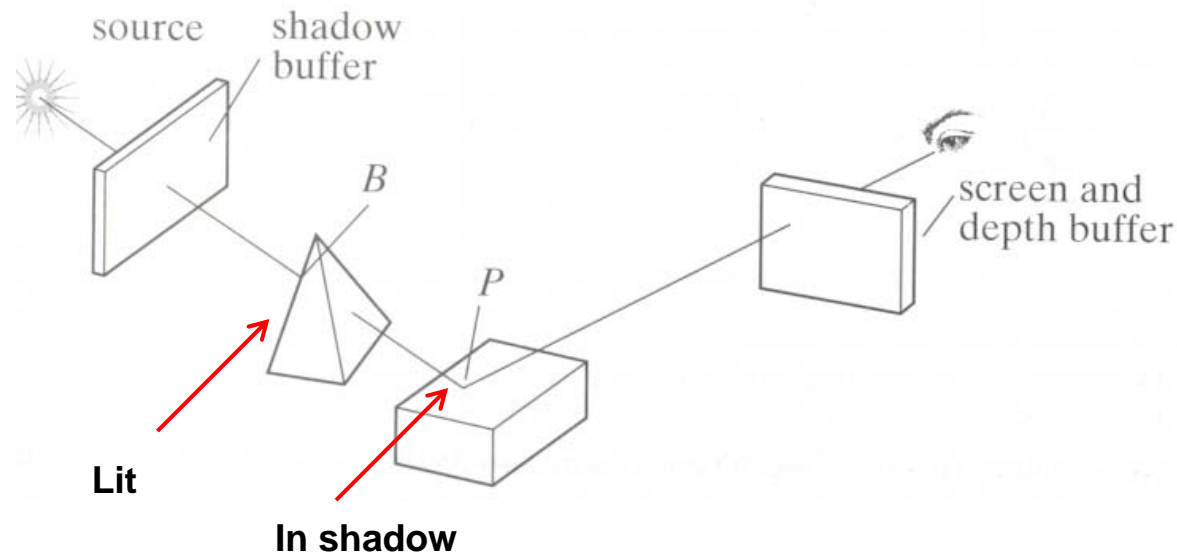

# Shadow Buffer Approach

- Rendering in two stages:
  - Loading shadow buffer
  - Render the scene

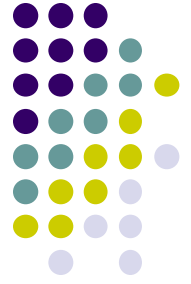



# Loading Shadow Buffer

- Initialize each element to 1.0
- Position a camera at light source
- Rasterize each face in scene updating closest object
- Shadow buffer tracks smallest depth on each path

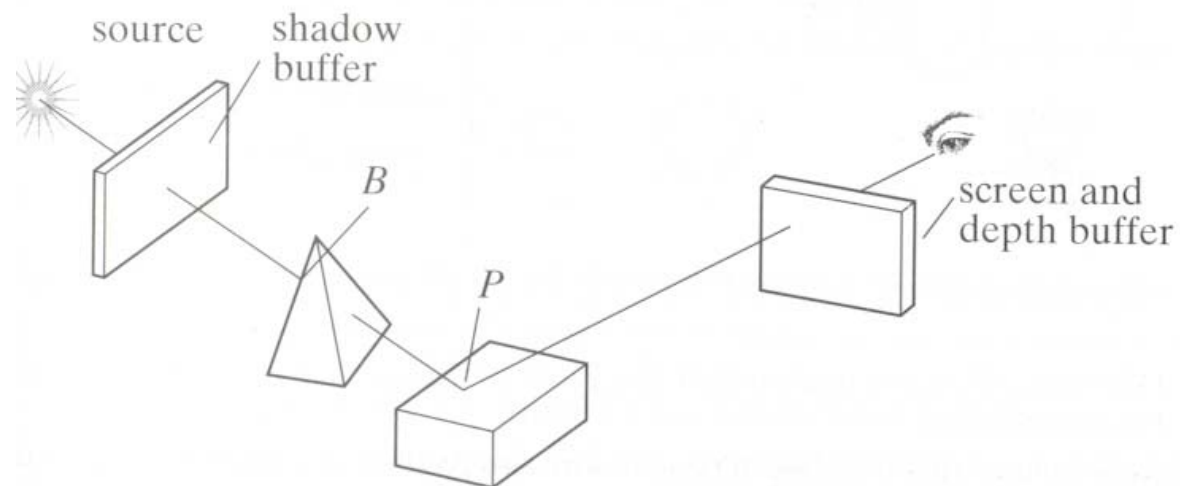



# Shadow Buffer (Rendering Scene)

- Render scene using camera as usual
- While rendering a pixel find:
  - pseudo-depth  $D$  from light source to  $P$
  - Index location  $[i][j]$  in shadow buffer, to be tested
  - Value  $d[i][j]$  stored in shadow buffer
- If  $d[i][j] < D$  (other object on this path closer to light)
  - point  $P$  is in shadow
  - set lighting using only ambient
- Otherwise, not in shadow

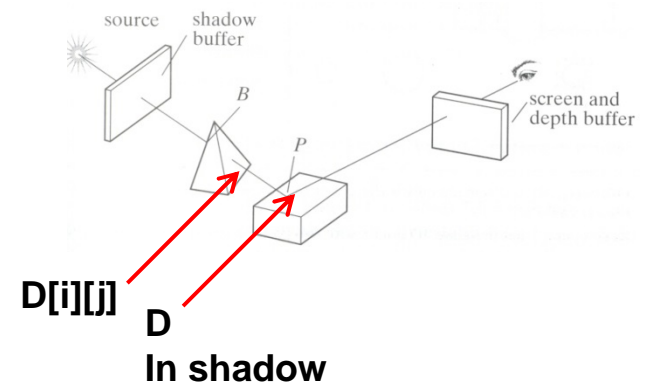



# Loading Shadow Buffer

- Shadow buffer calculation is independent of eye position
- In animations, shadow buffer loaded once
- If eye moves, no need for recalculation
- If objects move, recalculation required

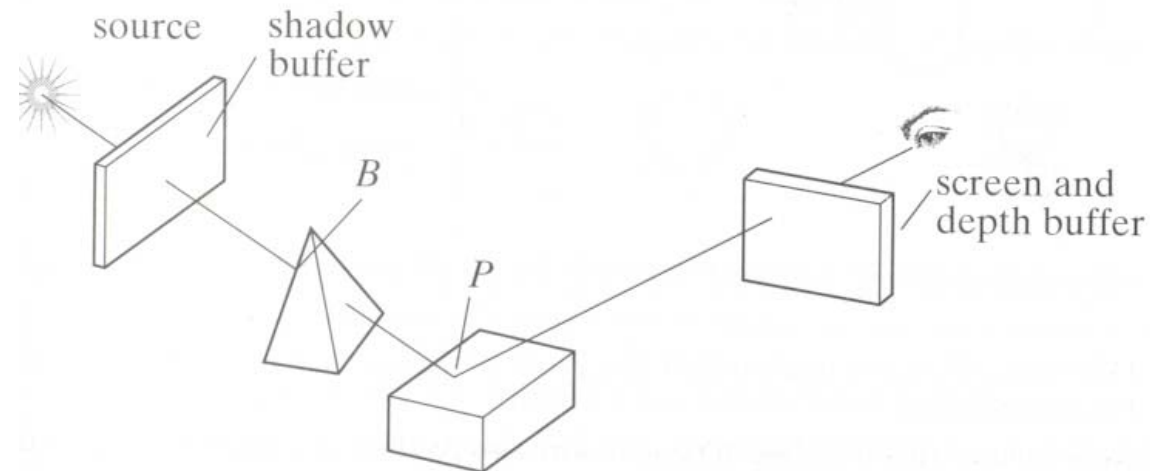



## Other Issues

- Point light sources => simple hard shadows, unrealistic
- Extended light sources => more realistic
- Shadow has two parts:
  - Umbra (Inner part) => no light
  - Penumbra (outer part) => some light

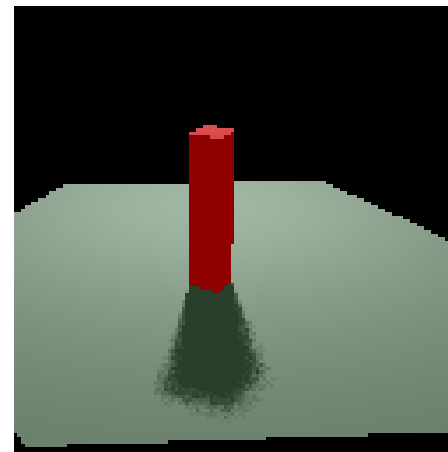
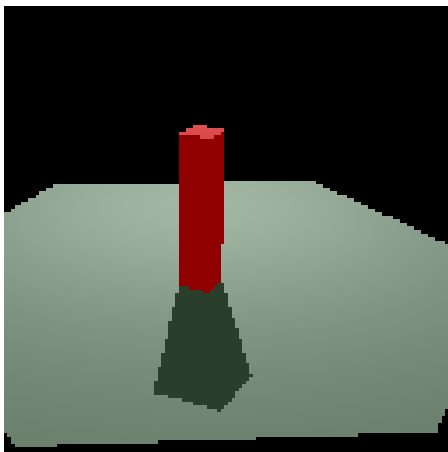



# Fog example

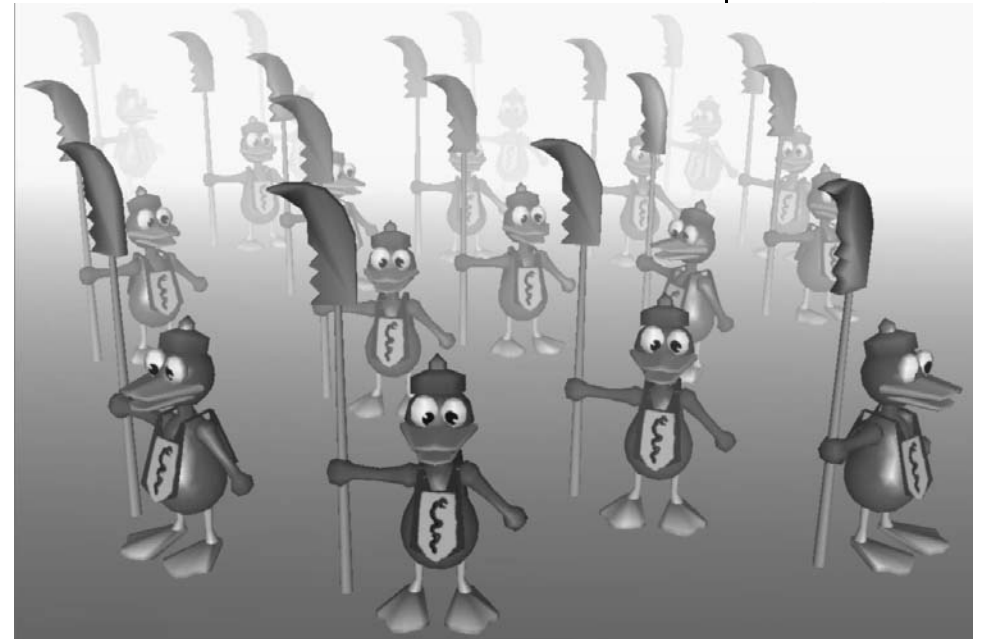
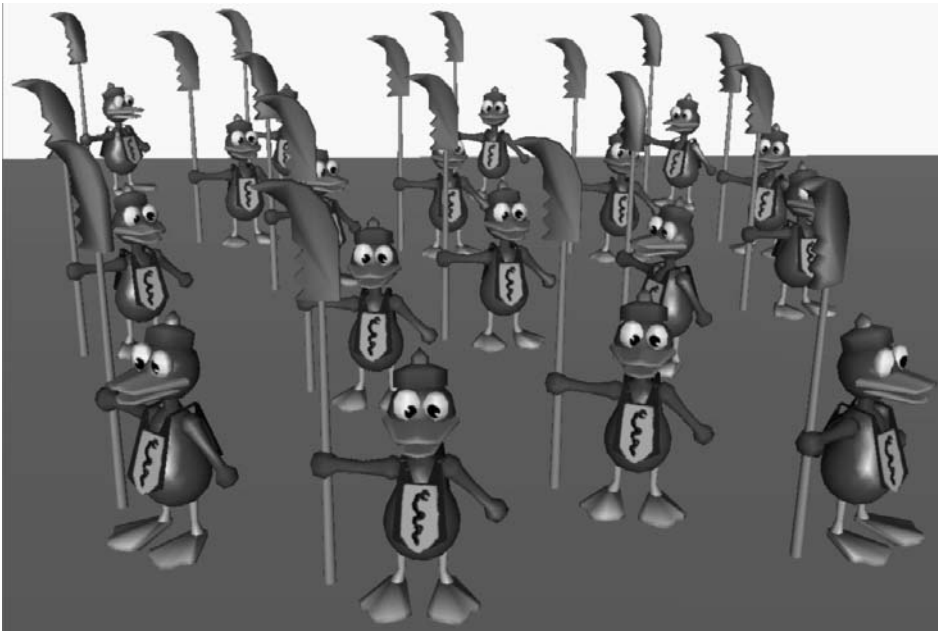

- Fog is atmospheric effect
  - Better realism, helps determine distances





# Fog

- Fog was part of OpenGL fixed function pipeline
- Programming fixed function fog
  - **Parameters:** Choose fog color, fog model
  - **Enable:** Turn it on
- Fixed function fog **deprecated!!**
- Shaders can implement even better fog
- **Shaders implementation:** fog applied in fragment shader just before display



# Rendering Fog

- Mix some color of fog:  $\mathbf{c}_f$  + color of surface:  $\mathbf{c}_s$

$$\mathbf{c}_p = f\mathbf{c}_f + (1-f)\mathbf{c}_s \quad f \in [0,1]$$

- If  $f = 0.25$ , output color = 25% fog + 75% surface color
  - $f$  computed as function of distance  $z$
  - 3 ways: linear, exponential, exponential-squared
  - Linear:

$$f = \frac{z_{end} - z_p}{z_{end} - z_{start}}$$

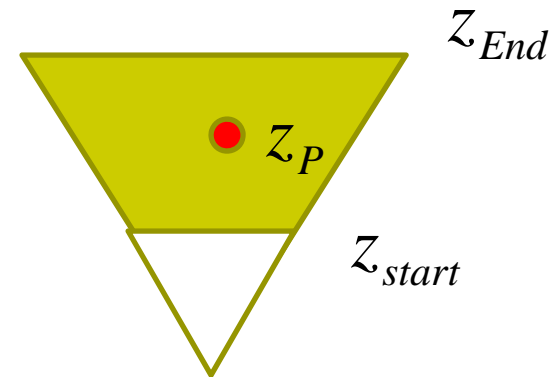

# Fog Shader Fragment Shader Example



$$f = \frac{z_{end} - z_p}{z_{end} - z_{start}}$$

```
float dist = abs(Position.z);  
Float fogFactor = (Fog.maxDist - dist) /  
                  Fog.maxDist - Fog.minDist);  
fogFactor = clamp(fogFactor, 0.0, 1.0);
```

```
vec3 shadeColor = ambient + diffuse + specular  
vec3 color = mix(Fog.color, shadeColor, fogFactor);  
FragColor = vec4(color, 1.0);
```

$$\mathbf{c}_p = f\mathbf{c}_f + (1-f)\mathbf{c}_s$$



# Fog

- Exponential  $f = e^{-d_f z_p}$
- Squared exponential  $f = e^{-(d_f z_p)^2}$
- Exponential derived from Beer's law
  - **Beer's law:** intensity of outgoing light diminishes exponentially with distance

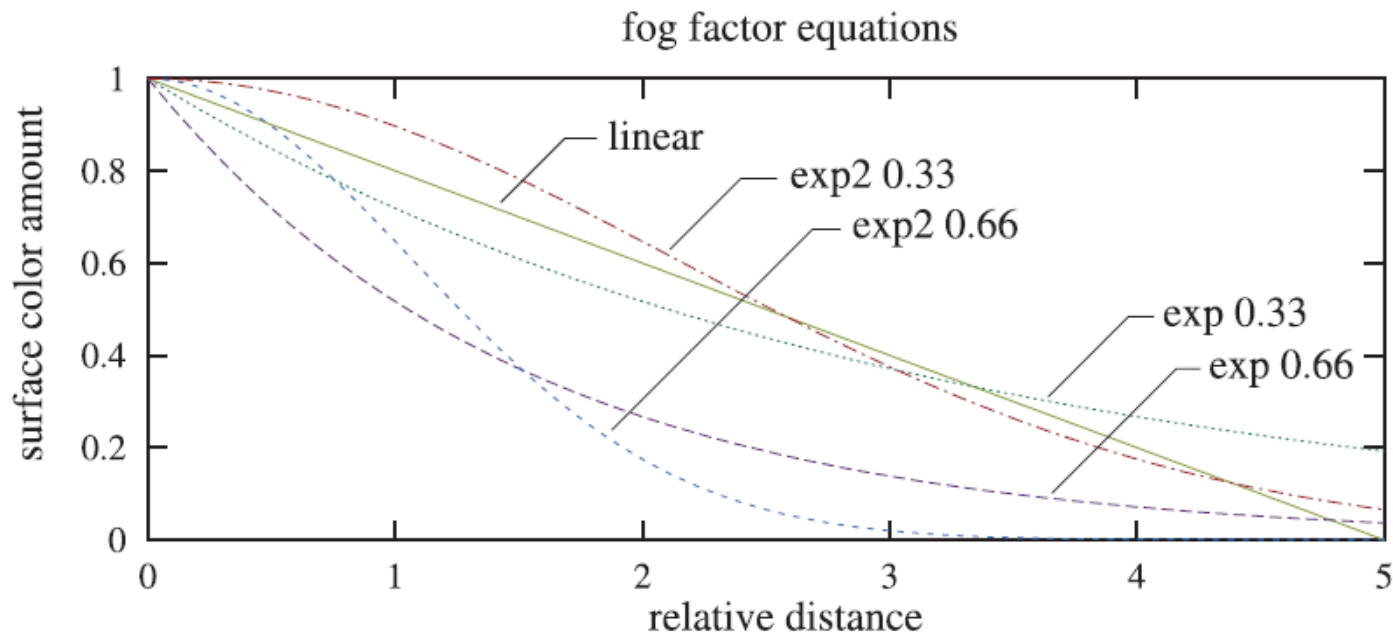



# Fog

- $f$  values for different depths ( $z_P$ ) can be pre-computed and stored in a table on GPU
- Distances used in  $f$  calculations are planar
- Can also use Euclidean distance from viewer or radial distance to create *radial fog*

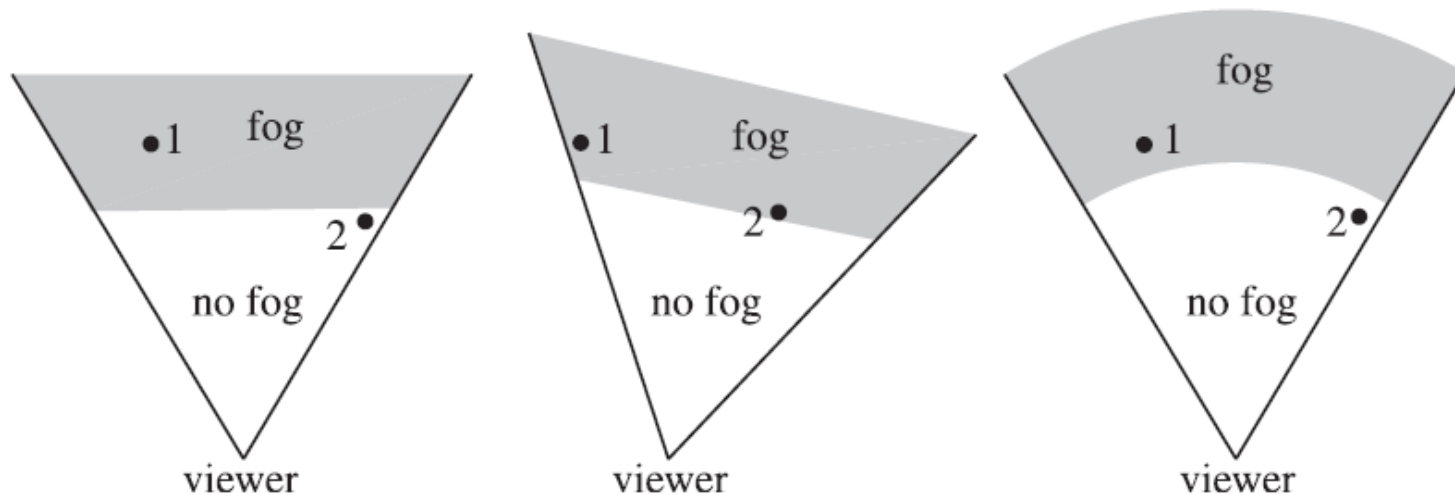



## References

- Interactive Computer Graphics (6<sup>th</sup> edition), Angel and Shreiner
- Computer Graphics using OpenGL (3<sup>rd</sup> edition), Hill and Kelley
- Real Time Rendering by Akenine-Moller, Haines and Hoffman