

# Computer Graphics (CS 543)

## Lecture 6b: Viewing & Camera Control

---

Prof Emmanuel Agu

*Computer Science Dept.  
Worcester Polytechnic Institute (WPI)*





# 3D Viewing?

- Specify a view volume
- Objects **inside** view volume drawn to viewport (screen)
- Objects outside view volume **clipped** (not drawn)!

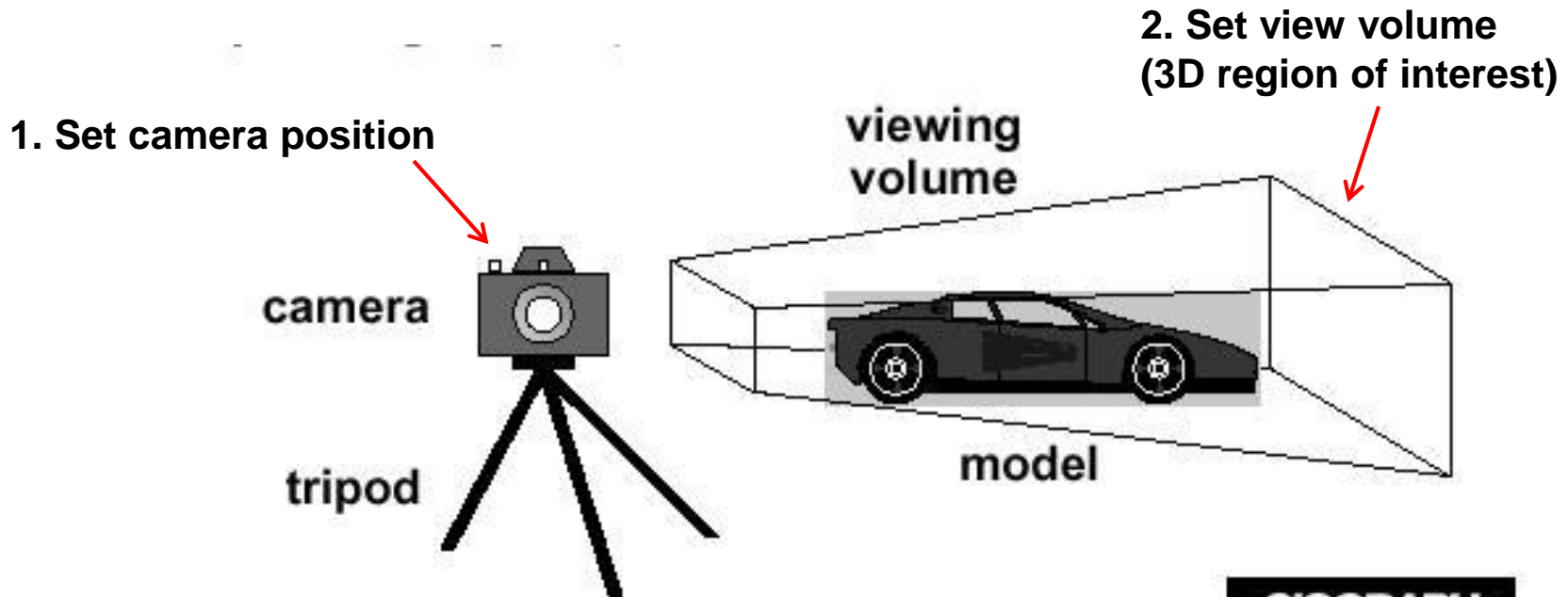

# Different View Volume Shapes

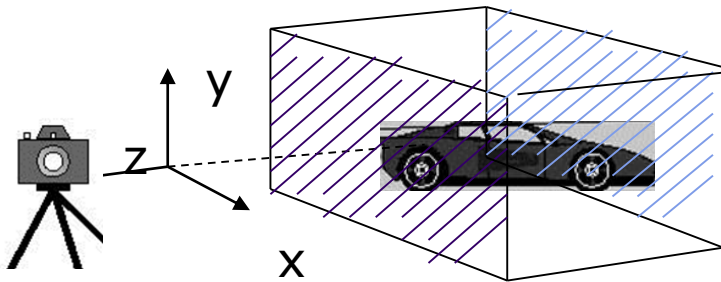

**Orthogonal view volume**

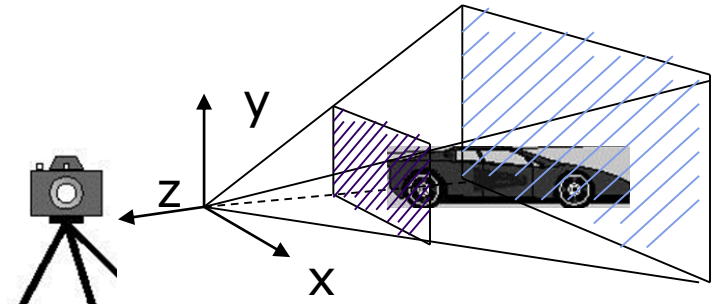

**Perspective view volume**

- Different view volume shape => different look
- **Foreshortening?** Near objects bigger
  - Perspective projection causes **foreshortening**
  - Orthogonal projection: no foreshortening





# The World Frame

- Object positions initially defined in **world frame**
- **World Frame origin** at  $(0,0,0)$
- Objects positioned, oriented (translate, scale, rotate transformations) applied to objects in **world frame**

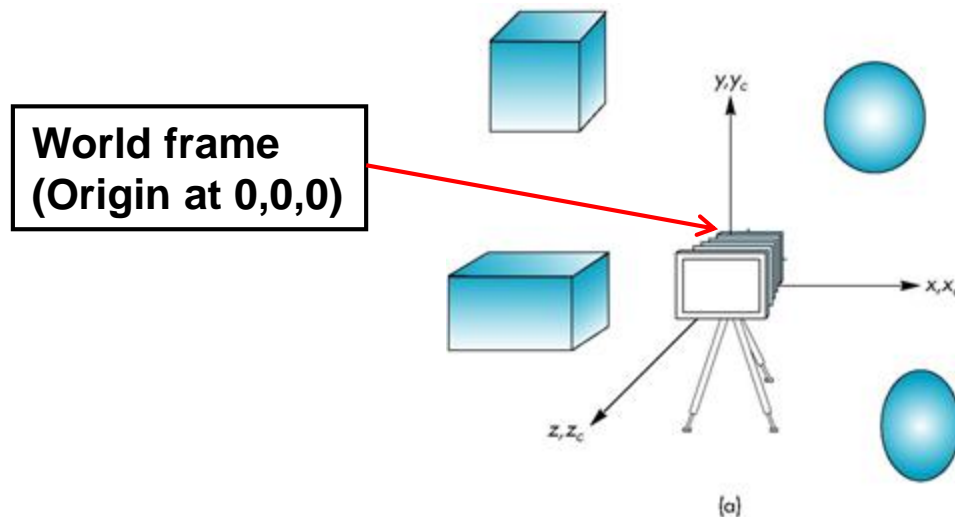



# Camera Frame

- More natural to describe object positions **relative to camera (eye)**
- Why?
  - Our view of the world
  - First person shooter games



# Camera Frame



- **Viewing:** After user chooses camera (eye) position, represent objects in **camera frame** (origin at eye position)
- **Viewing transformation:** Converts object  $(x,y,z)$  positions in world frame to positions in camera frame

Objects initially Specified in world frame

World frame  
(Origin at 0,0,0)

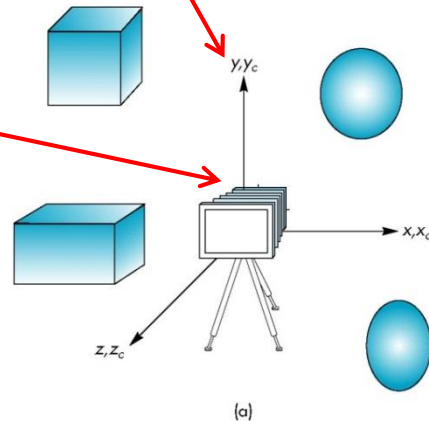

More natural to view  
Objects in camera frame

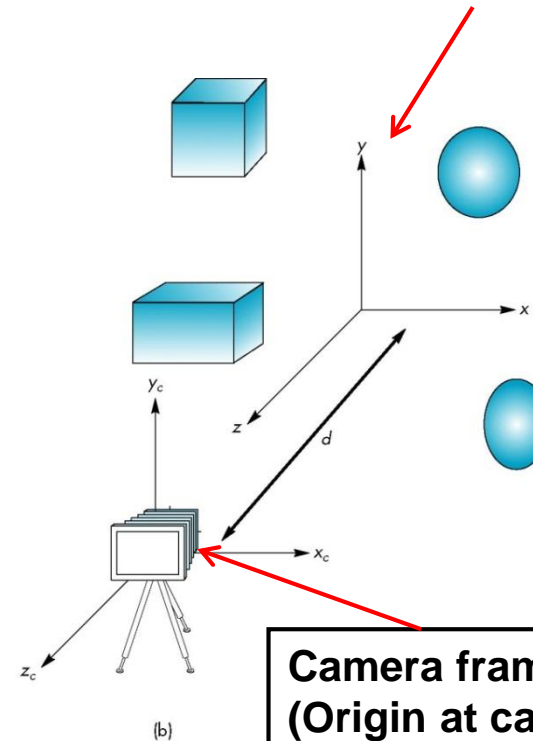

Camera frame  
(Origin at camera)



# Default OpenGL Camera, View Volume

- Initially Camera at origin: object and camera frames same
- Points in negative z direction
- Default view volume is cube with sides of length 2

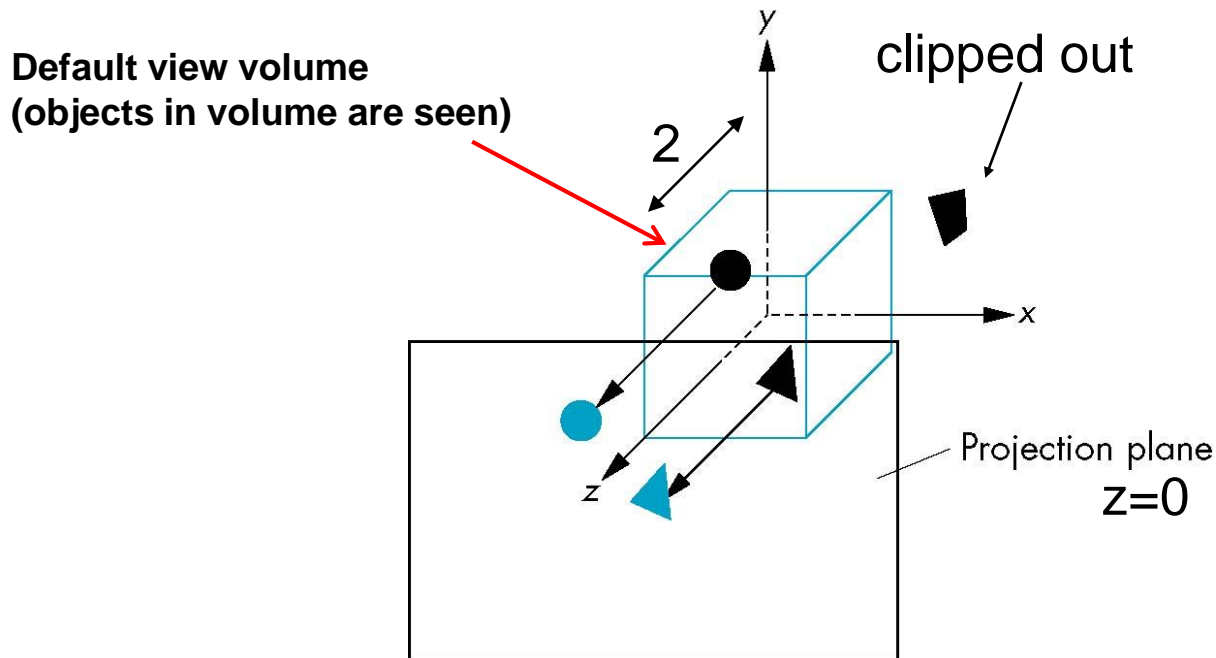

# Moving Camera Frame



Same RELATIVE distance after  
Same result/look

default frames

Translate **objects -5**  
away from camera

Translate **camera +5**  
away from objects

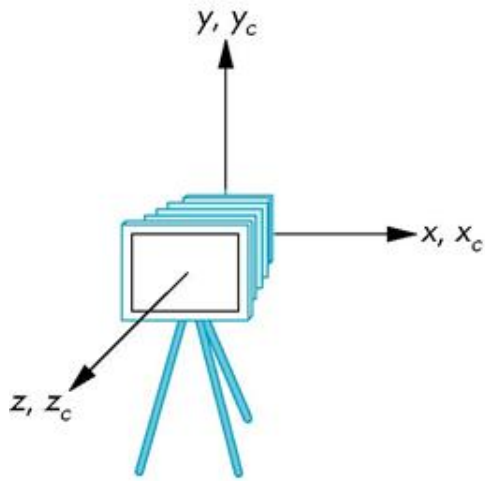

(a)

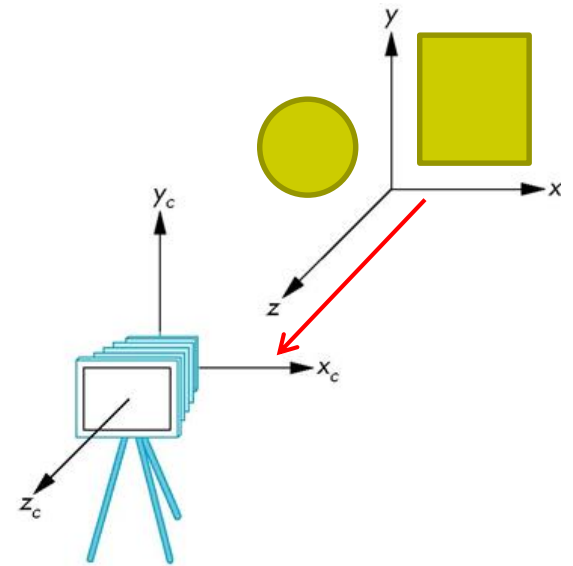
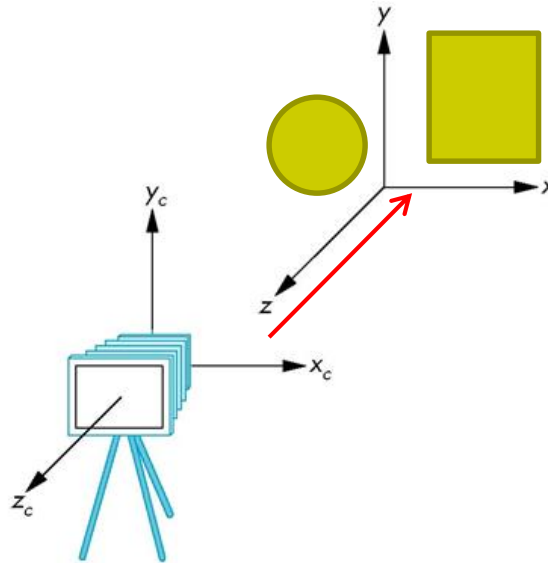





# Moving the Camera Frame

- Object distances **relative to camera** determined by the model-view matrix
  - Transforms (scale, translate, rotate) go into **modelview matrix**
  - Camera transforms also go in **modelview matrix (CTM)**
  - Why? Combination of object + camera transforms = relative transform

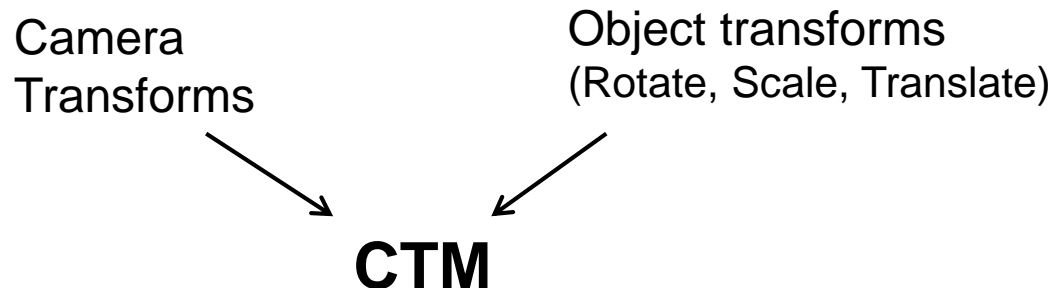



# Moving the Camera

- We can move camera using sequence of rotations and translations
- Example: side view
  - Rotate the camera
  - Move it away from origin
  - Model-view matrix  $C = TR$

```
// Using mat.h
```

```
mat4 t = Translate (0.0, 0.0, -d);  
mat4 ry = RotateY(90.0);  
mat4 m = t*ry;
```

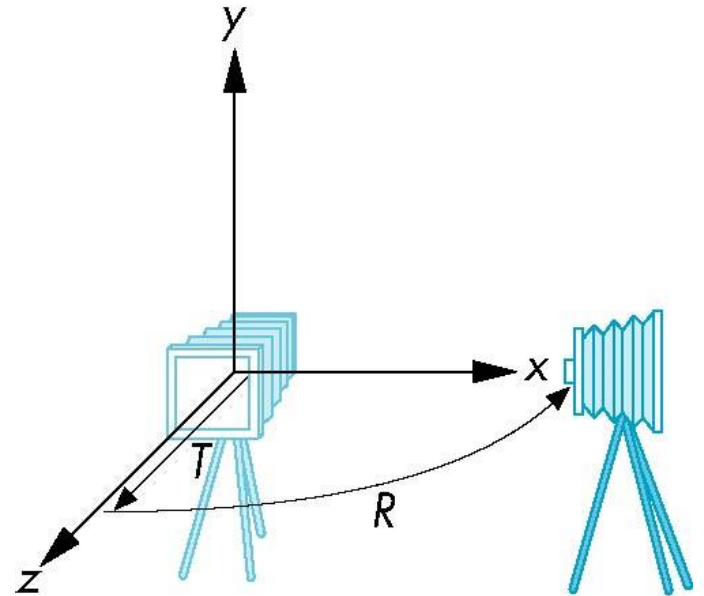



# The LookAt Function

- Previously, command **gluLookAt** to position camera
- **gluLookAt** deprecated!!
- Homegrown mat4 method LookAt() in mat.h
  - Functionality: sets camera position, transforms object distances to camera frame

```
void display( ) {  
    .....  
  
    mat4 mv = LookAt(vec4 eye, vec4 at, vec4 up);  
    .....  
}
```

Builds 4x4 matrix for positioning, orienting Camera and puts it into variable **mv**



# The LookAt Function

LookAt(*eye*, *at*, *up*)

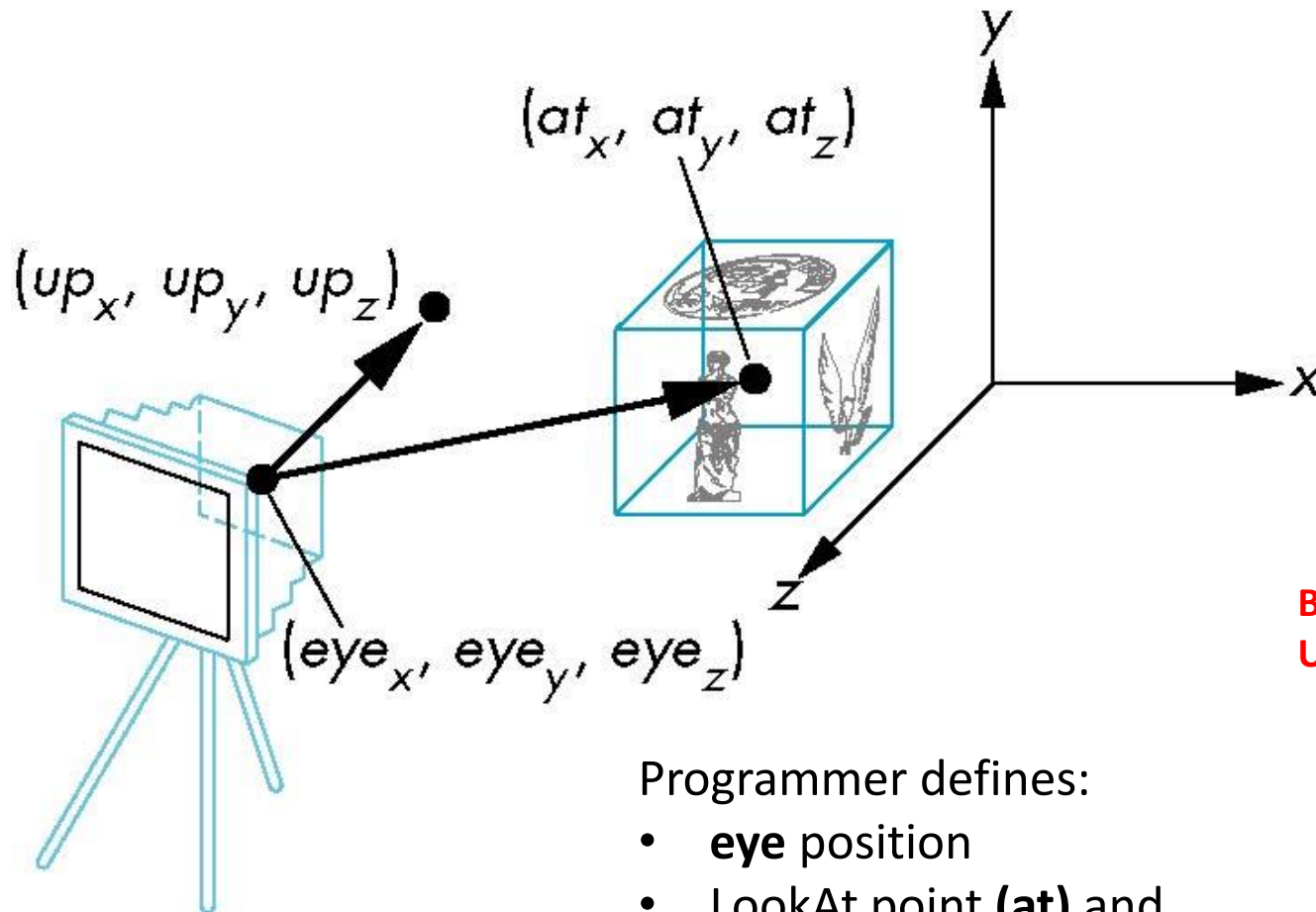

But Why do we set  
Up direction?

Programmer defines:

- **eye** position
- LookAt point (**at**) and
- **Up** vector (**Up** direction usually (0,1,0))

# Nate Robbins LookAt Demo



World-space view

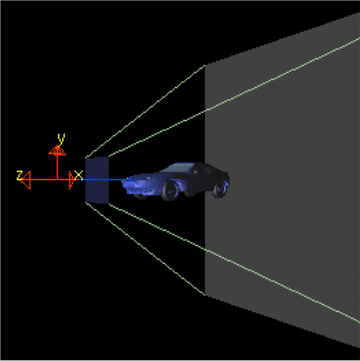

Screen-space view



Command manipulation window

```
glTranslatef( 0.00 , 0.00 , 0.00 );  
glRotatef( 0.0 , 0.00 , 1.00 , 0.00 );  
glScalef( 1.00 , 1.00 , 1.00 );  
glBegin( ... );  
...  
Click on the arguments and move the mouse to modify values.
```

World-space view

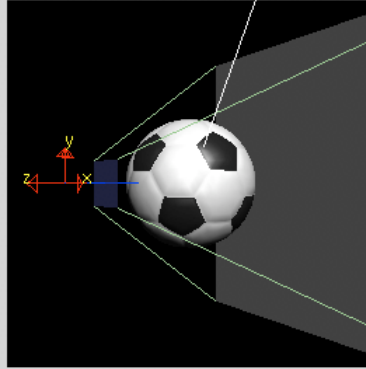

Screen-space view



Command manipulation window

```
GLfloat pos[4] = { 1.50 , 1.00 , 1.00 , 0.00 };  
gluLookAt( 0.00 , 0.00 , 2.00 , <- eye  
          0.00 , 0.00 , 0.00 , <- center  
          0.00 , 1.00 , 0.00 ); <- up  
glLightfv(GL_LIGHT0, GL_POSITION, pos);  
Click on the arguments and move the mouse to modify values.
```

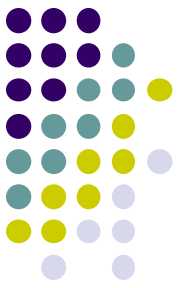

# What does LookAt do?

- Programmer defines eye, lookAt and Up
- **LookAt method:**
  - Forms new axes (u, v, n) at camera
  - Transform objects from world to eye camera frame

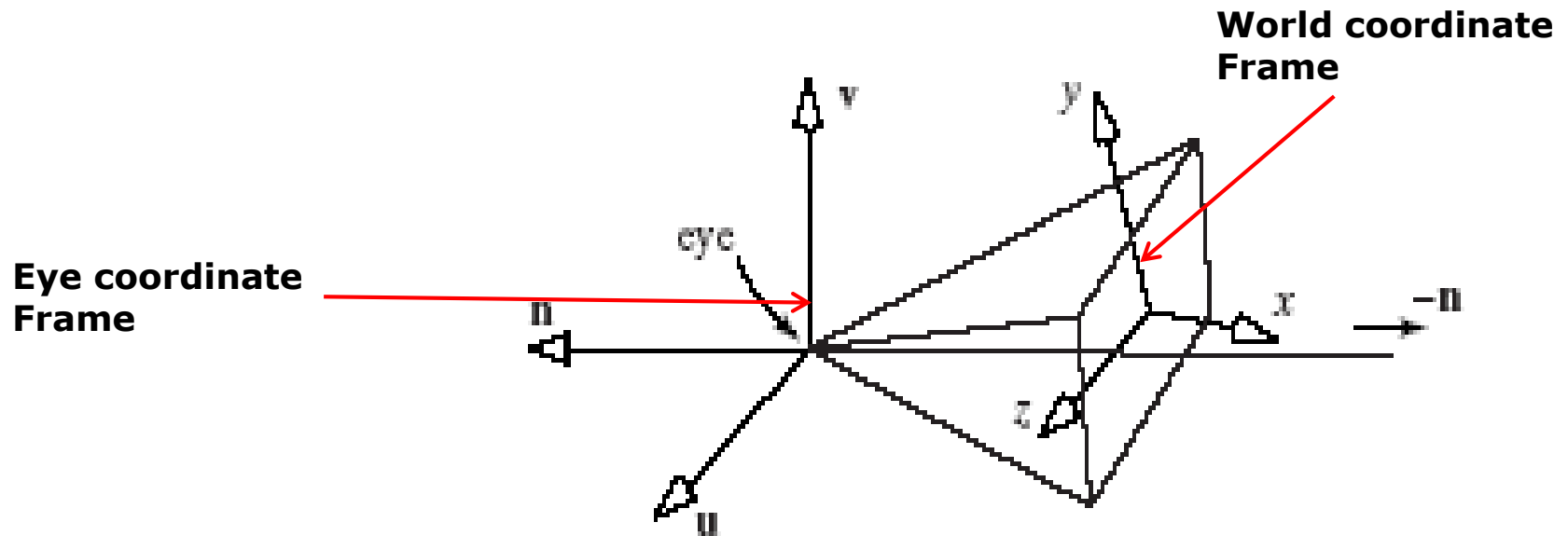

# Camera with Arbitrary Orientation and Position

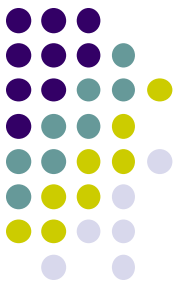

- Define new axes ( $u, v, n$ ) at eye
  - $v$  points vertically upward,
  - $n$  away from the view volume,
  - $u$  at right angles to both  $n$  and  $v$ .
  - The camera looks toward  $-n$ .
  - All vectors are normalized.

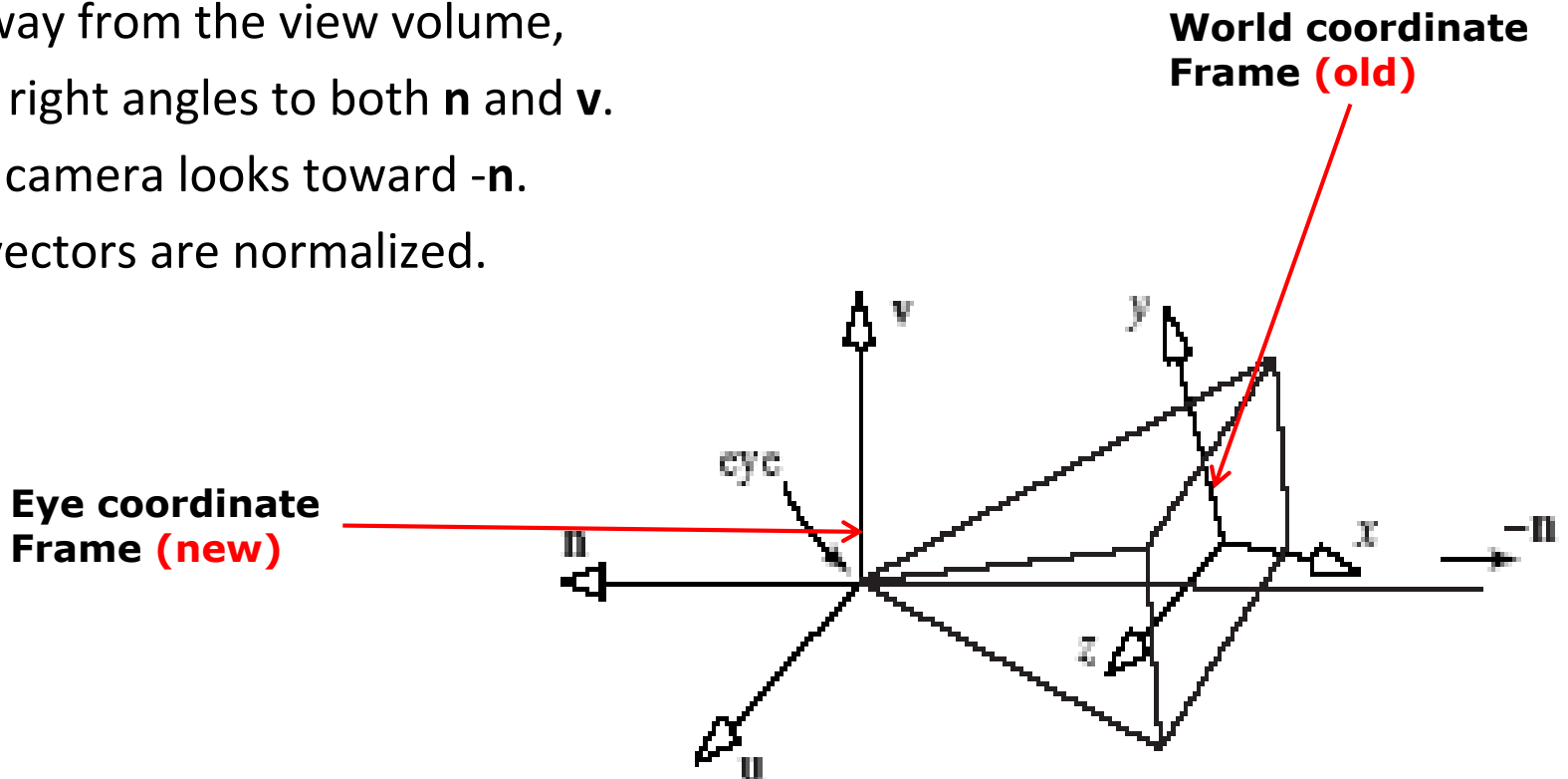



# LookAt: Effect of Changing Eye Position or LookAt Point

- Programmer sets **LookAt** (**eye**, **at**, **up**)
- If **eye**, **lookAt** point changes => **u,v,n** changes

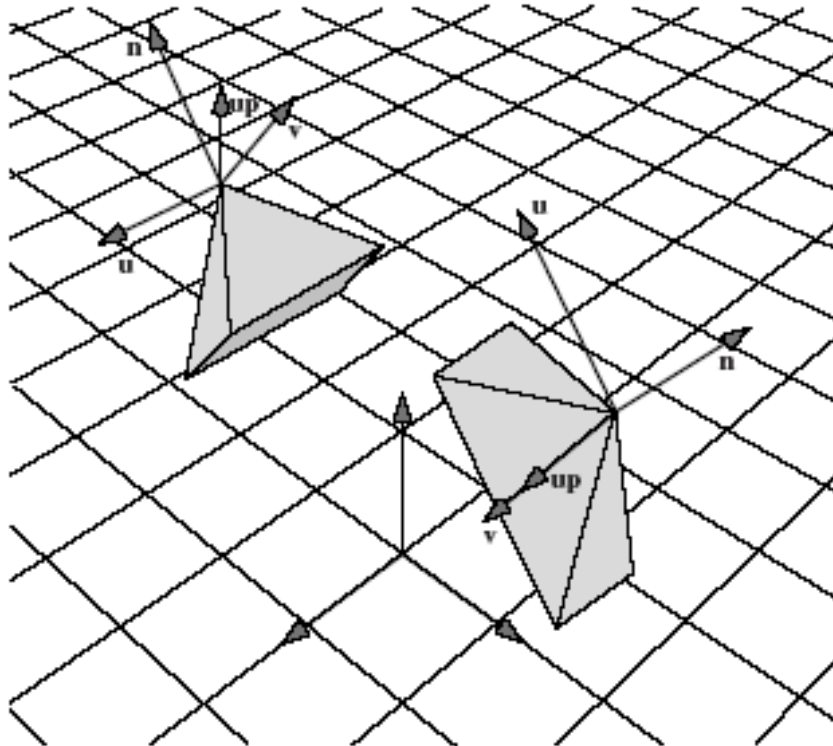





# Viewing Transformation Steps

1. Form camera (u,v,n) frame
2. Transform objects from world frame (Compose matrix to transform coordinates)

- Next, let's form camera (u,v,n) frame

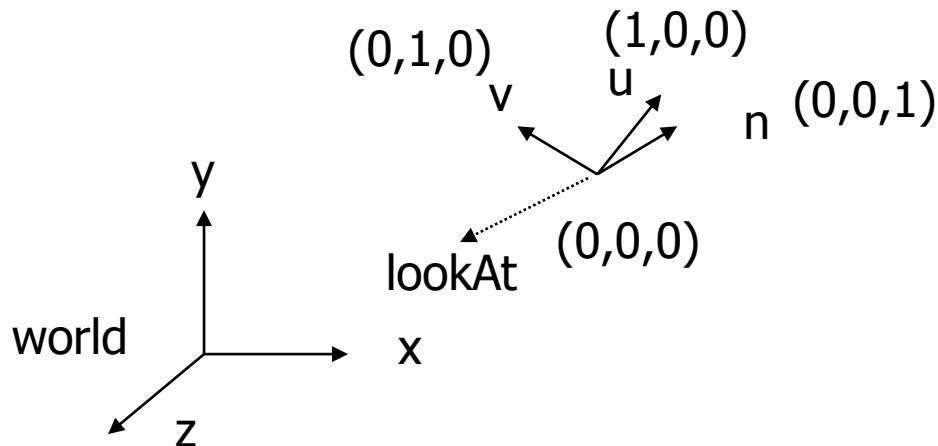



# Constructing U,V,N Camera Frame

- Lookat arguments: **LookAt** (**eye**, **at**, **up**)
- **Known:** eye position, LookAt Point, up vector
- **Derive:** new origin and three basis (u,v,n) vectors

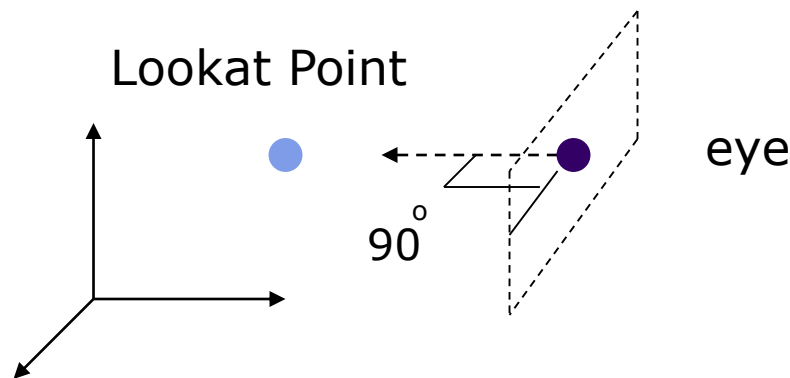



# Eye Coordinate Frame

- **New Origin:** eye position (that was easy)
- 3 basis vectors:
  - one is the normal vector (**n**) of the viewing plane,
  - other two (**u** and **v**) span the viewing plane

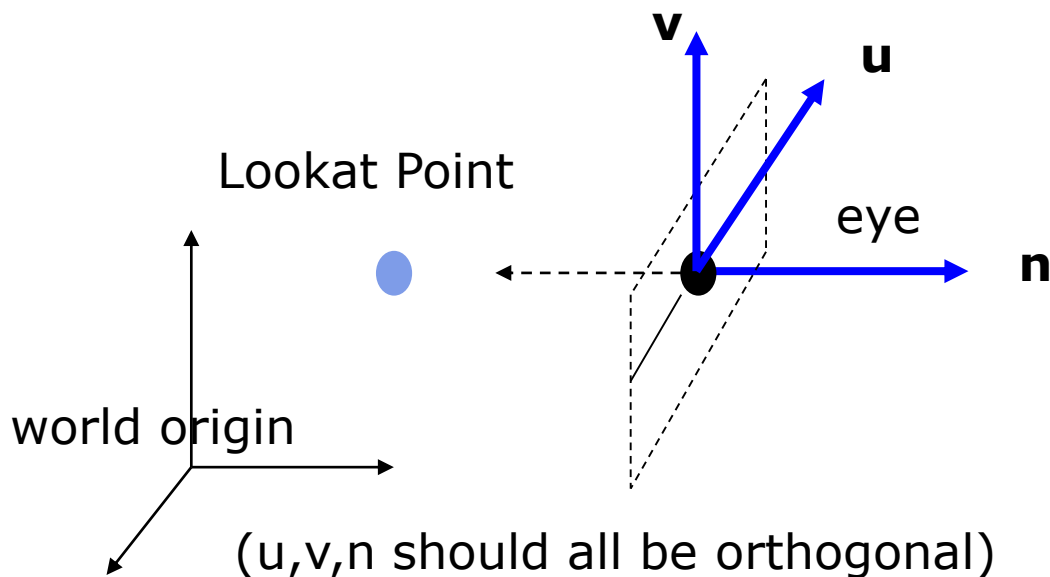

**n** is pointing away from the world because we use left hand coordinate system

$$\mathbf{N} = \text{eye} - \text{Lookat Point}$$
$$\mathbf{n} = \mathbf{N} / |\mathbf{N}|$$

Remember **u,v,n** should be all unit vectors  
So... Normalize vectors!!!!



# Eye Coordinate Frame

- How about  $u$  and  $v$ ?

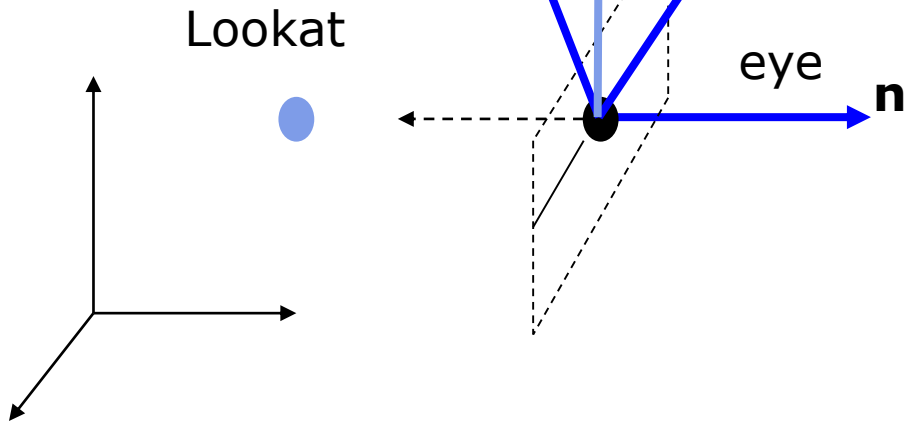

- Derive  $u$  first -
  - $u$  is a vector that is perp to the plane spanned by  $N$  and view up vector ( $V\_up$ )

$$U = V\_up \times n$$

$$u = U / |U|$$



# Eye Coordinate Frame

- How about  $v$ ?

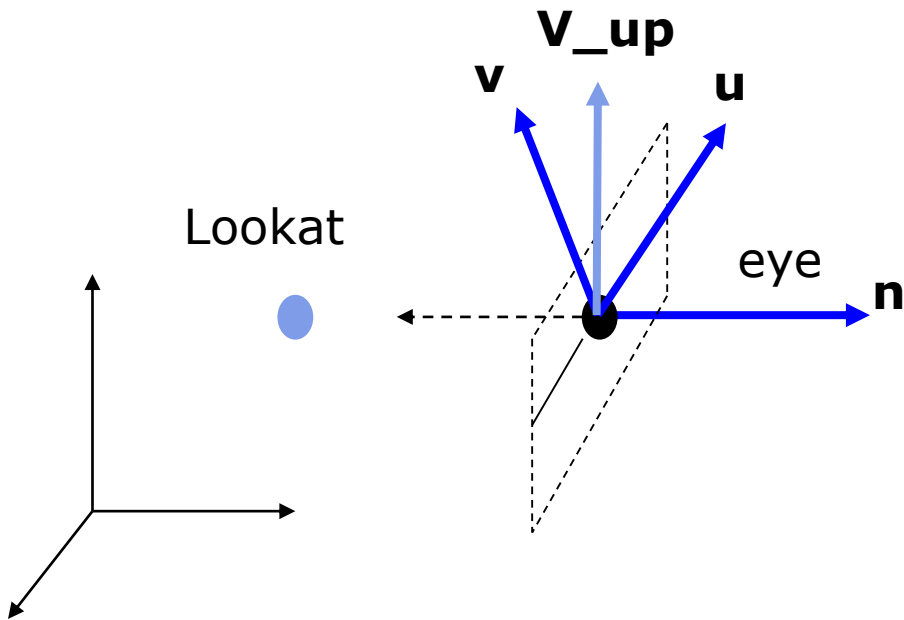

To derive  $v$  from  $n$  and  $u$

$$\mathbf{v} = \mathbf{n} \times \mathbf{u}$$

**$v$  is already normalized**



# Eye Coordinate Frame

- Put it all together

Eye space **origin: (Eye.x , Eye.y, Eye.z)**

Basis vectors:

$$\mathbf{n} = (\text{eye} - \text{Lookat}) / |\text{eye} - \text{Lookat}|$$

$$\mathbf{u} = (\mathbf{V\_up} \times \mathbf{n}) / |\mathbf{V\_up} \times \mathbf{n}|$$

$$\mathbf{v} = \mathbf{n} \times \mathbf{u}$$

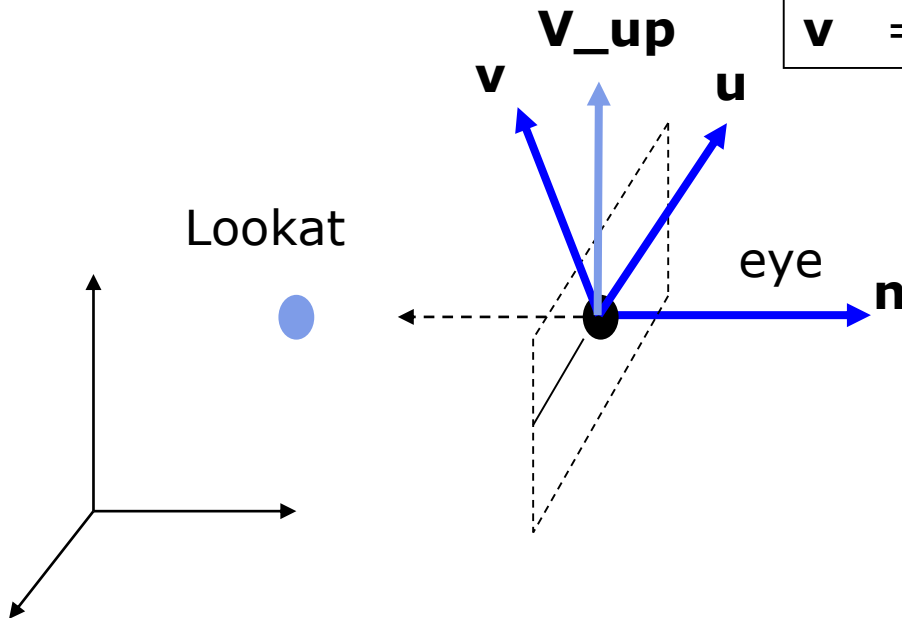



# Step 2: World to Eye Transformation

- Next, use  $u, v, n$  to compose LookAt matrix
- Transformation matrix ( $M_{w2e}$ ) ?
  - Matrix that transforms a point  $P$  in world frame to  $P'$  in eye frame

$$P' = M_{w2e} P$$

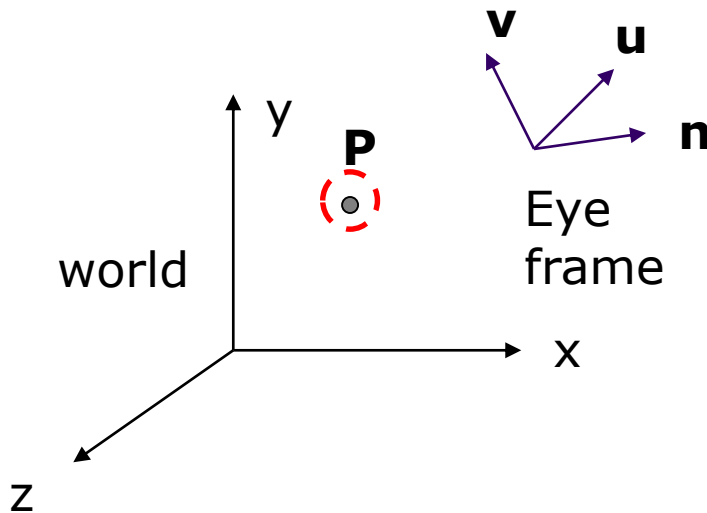

1. Come up with transformation sequence that aligns eye frame with world frame

2. Apply this transform sequence to point  $P$  in reverse order



# World to Eye Transformation

1. Rotate eye frame to “align” it with world frame
2. Translate  $(-ex, -ey, -ez)$  to align origin with eye

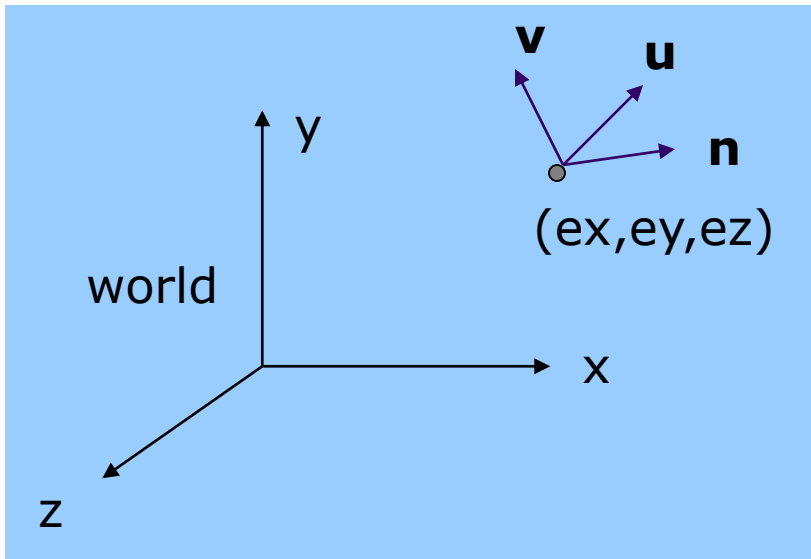

Rotation:

$$\begin{vmatrix} ux & uy & uz & 0 \\ vx & vy & vz & 0 \\ nx & ny & nz & 0 \\ 0 & 0 & 0 & 1 \end{vmatrix}$$

Translation:

$$\begin{vmatrix} 1 & 0 & 0 & -ex \\ 0 & 1 & 0 & -ey \\ 0 & 0 & 1 & -ez \\ 0 & 0 & 0 & 1 \end{vmatrix}$$



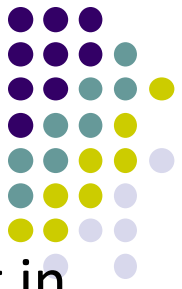

# World to Eye Transformation

- Transformation order: apply the transformation to the object in reverse order - translation first, and then rotate

← Order

$M_{w2e} =$

$$\begin{array}{cc} \text{Rotation} & \text{Translation} \\ \left| \begin{array}{cccc} u_x & u_y & u_z & 0 \\ v_x & v_y & v_z & 0 \\ n_x & n_y & n_z & 0 \\ 0 & 0 & 0 & 1 \end{array} \right| & \left| \begin{array}{cccc} 1 & 0 & 0 & -e_x \\ 0 & 1 & 0 & -e_y \\ 0 & 0 & 1 & -e_z \\ 0 & 0 & 0 & 1 \end{array} \right| \end{array}$$



$$= \left| \begin{array}{cccc} u_x & u_y & u_z & -\mathbf{e} \cdot \mathbf{u} \\ v_x & v_y & v_z & -\mathbf{e} \cdot \mathbf{v} \\ n_x & n_y & n_z & -\mathbf{e} \cdot \mathbf{n} \\ 0 & 0 & 0 & 1 \end{array} \right|$$

Multiplied together = lookAt transform

Note:  $\mathbf{e} \cdot \mathbf{u} = e_x \cdot u_x + e_y \cdot u_y + e_z \cdot u_z$

$\mathbf{e} \cdot \mathbf{v} = e_x \cdot v_x + e_y \cdot v_y + e_z \cdot v_z$

$\mathbf{e} \cdot \mathbf{n} = e_x \cdot n_x + e_y \cdot n_y + e_z \cdot n_z$

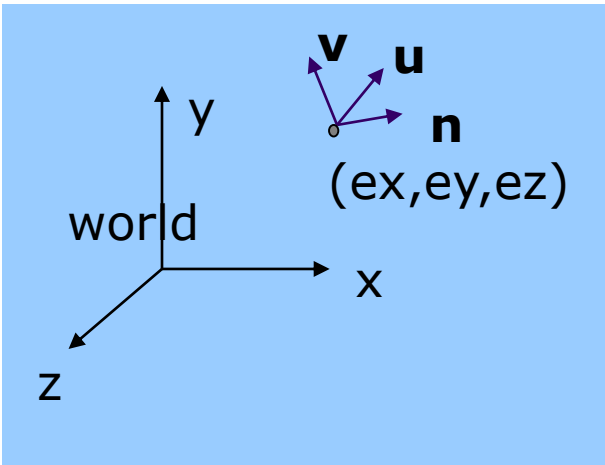



# lookAt Implementation (from mat.h)

Eye space **origin: (Eye.x , Eye.y, Eye.z)**

Basis vectors:

$$\begin{aligned}\mathbf{n} &= (\text{eye} - \text{Lookat}) / |\text{eye} - \text{Lookat}| \\ \mathbf{u} &= (\mathbf{V\_up} \times \mathbf{n}) / |\mathbf{V\_up} \times \mathbf{n}| \\ \mathbf{v} &= \mathbf{n} \times \mathbf{u}\end{aligned}$$

$$\begin{vmatrix} u_x & u_y & u_z & -\mathbf{e} \cdot \mathbf{u} \\ v_x & v_y & v_z & -\mathbf{e} \cdot \mathbf{v} \\ n_x & n_y & n_z & -\mathbf{e} \cdot \mathbf{n} \\ 0 & 0 & 0 & 1 \end{vmatrix}$$

```
mat4 LookAt( const vec4& eye, const vec4& at, const vec4& up )
{
    vec4 n = normalize(eye - at);
    vec4 u = normalize(cross(up, n));
    vec4 v = normalize(cross(n, u));
    vec4 t = vec4(0.0, 0.0, 0.0, 1.0);
    mat4 c = mat4(u, v, n, t);
    return c * Translate( -eye );
}
```



# Other Camera Controls

- The LookAt function is only for positioning camera
- Other ways to specify camera position/orientation/movement
  - Yaw, pitch, roll
  - Elevation, azimuth, twist
  - Direction angles



# Flexible Camera Control

- Sometimes, we want camera to move
- Like controlling an airplane's orientation
- Adopt aviation terms:
  - **Pitch:** nose up-down
  - **Roll:** roll body of plane
  - **Yaw:** move nose side to side

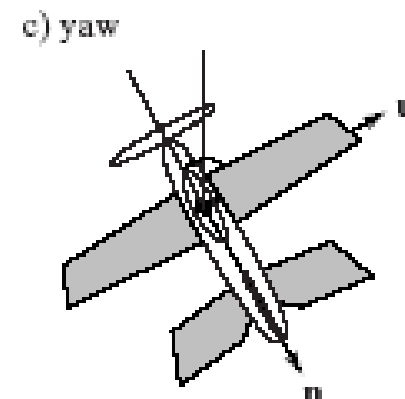
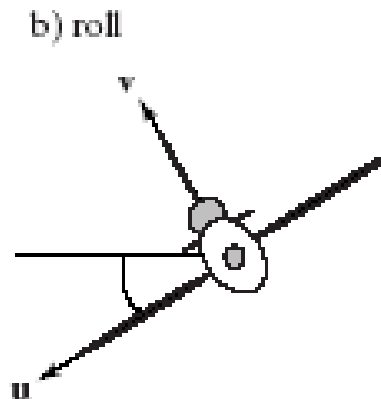
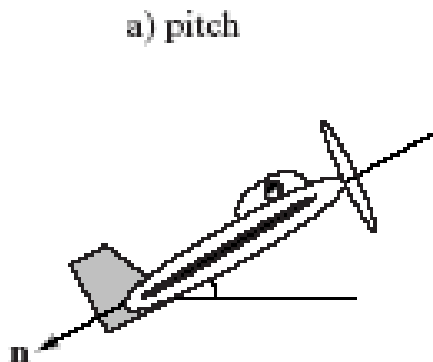

# Yaw, Pitch and Roll Applied to Camera



a) camera orientation

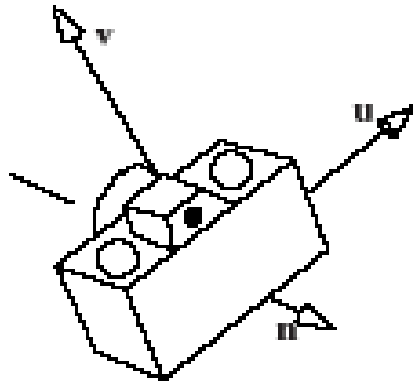

b) with roll

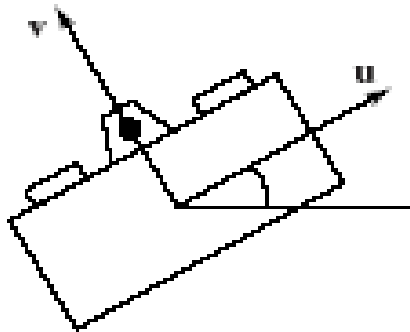

c) no roll

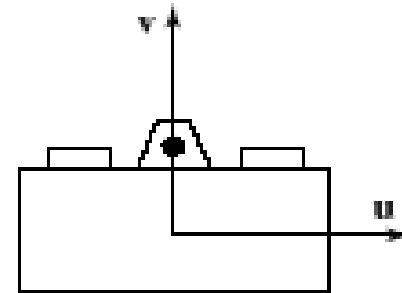

# Flexible Camera Control



- Create a **camera** class

```
class Camera
  private:
    Point3 eye;
    Vector3 u, v, n;... etc
```

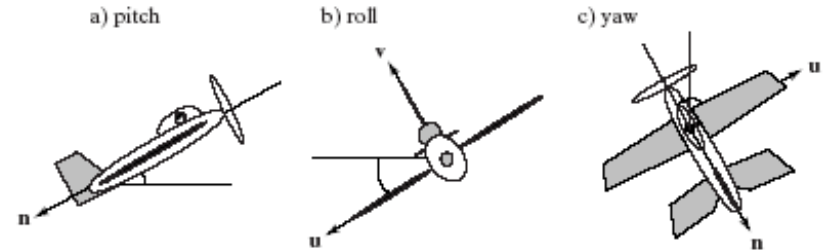

- Camera methods (functions) to specify slide, pitch, roll, yaw wrt u,v,n. E.g

```
cam.slide(1, 0, 2); // slide camera backward 2 and right 1
cam.roll(30); // roll camera 30 degrees
cam.yaw(40); // yaw camera 40 degrees
cam.pitch(20); // pitch camera 20 degrees
```

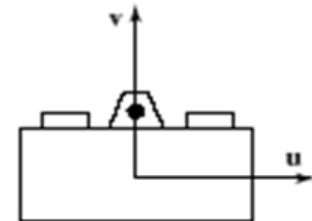

# Recall: Final LookAt Matrix

- Slide along u, v or n
- Changes eye position
- Changes these components

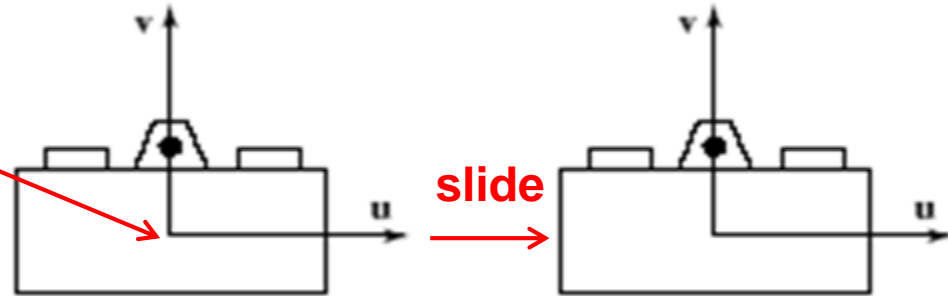

$$\begin{bmatrix} ux & uy & uz & -\mathbf{e} \cdot \mathbf{u} \\ vx & vy & vz & -\mathbf{e} \cdot \mathbf{v} \\ nx & ny & nz & -\mathbf{e} \cdot \mathbf{n} \\ 0 & 0 & 0 & 1 \end{bmatrix}$$

- Pitch, yaw, roll rotates u, v or n
- Changes u, v or n
- E.g. roll rotates u,v

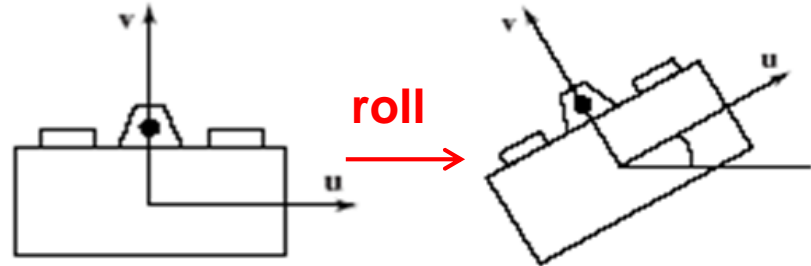

**Question: Pitch rotates which axes?**



# Implementing Flexible Camera Control

- Camera class: maintains current (u,v,n) and eye position

```
class Camera
private:
    Point3 eye;
    Vector3 u, v, n;... etc
```

- User inputs desired roll, pitch, yaw angle or slide
  1. **Roll, pitch, yaw:** calculate modified vector ( $u'$ ,  $v'$ ,  $n'$ )
  2. **Slide:** Calculate new eye position
  3. Update lookAt matrix, Load it into CTM





## Example: Camera Slide

- Recall: the axes are unit vectors
- User changes eye by delU, delV or delN
- $\text{eye} = \text{eye} + \text{changes}(\text{delU}, \text{delV}, \text{delN})$
- Note: function below combines all slides into one  
E.g moving camera by  **$D$**  along its u axis =  **$\text{eye} + D\mathbf{u}$**

```
void camera::slide(float delU, float delV, float delN)
{
    eye.x += delU*u.x + delV*v.x + delN*n.x;
    eye.y += delU*u.y + delV*v.y + delN*n.y;
    eye.z += delU*u.z + delV*v.z + delN*n.z;
    setModelViewMatrix( ); ←———— Function to update new eye, u, v and n
}
```

# Load Matrix into CTM



$$\begin{array}{ccc|c} ux & uy & uz & -\mathbf{e} \cdot \mathbf{u} \\ vx & vy & vz & -\mathbf{e} \cdot \mathbf{v} \\ nx & ny & nz & -\mathbf{e} \cdot \mathbf{n} \\ 0 & 0 & 0 & 1 \end{array}$$

```
void Camera::setModelViewMatrix(void)
{ // load modelview matrix with camera values
  mat4 m;
  Vector3 eVec(eye.x, eye.y, eye.z); // eye as vector
  m[0] = u.x; m[4] = u.y; m[8] = u.z; m[12] = -dot(eVec, u);
  m[1] = v.x; m[5] = v.y; m[9] = v.z; m[13] = -dot(eVec, v);
  m[2] = n.x; m[6] = n.y; m[10] = n.z; m[14] = -dot(eVec, n);
  m[3] = 0; m[7] = 0; m[11] = 0; m[15] = 1.0;
  CTM = m; // Finally, load matrix m into CTM Matrix
}
```

- Slide changes **eVec**,
- roll, pitch, yaw, change **u, v, n**
- Call setModelViewMatrix after slide, roll, pitch or yaw



# Example: Camera Roll

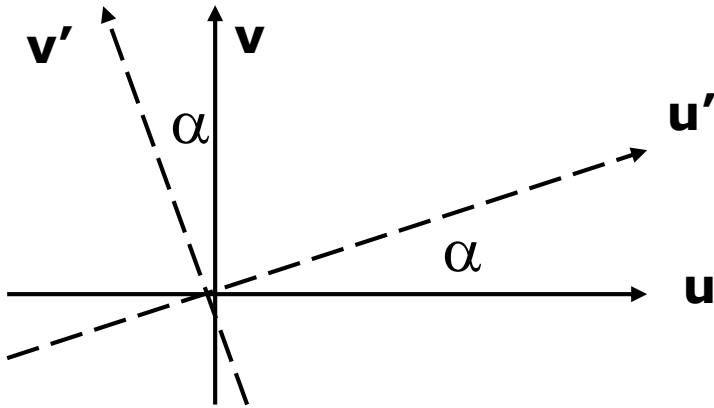

$$\mathbf{u}' = \cos(\alpha)\mathbf{u} + \sin(\alpha)\mathbf{v}$$

$$\mathbf{v}' = -\sin(\alpha)\mathbf{u} + \cos(\alpha)\mathbf{v}$$

```
void Camera::roll(float angle)
{ // roll the camera through angle degrees
  float cs = cos(3.142/180 * angle);
  float sn = sin(3.142/180 * angle);
  Vector3 t = u; // remember old u
  u.set(cs*t.x - sn*v.x, cs*t.y - sn*v.y, cs*t.z - sn*v.z);
  v.set(sn*t.x + cs*v.x, sn*t.y + cs*v.y, sn*t.z + cs*v.z)
  setModelViewMatrix( );
}
```



# References

- Interactive Computer Graphics, Angel and Shreiner, Chapter 4
- Computer Graphics using OpenGL (3<sup>rd</sup> edition), Hill and Kelley