

# Computer Graphics (CS 4731)

## Lecture 12: Hierarchical 3D Models

---

Prof Emmanuel Agu

*Computer Science Dept.  
Worcester Polytechnic Institute (WPI)*

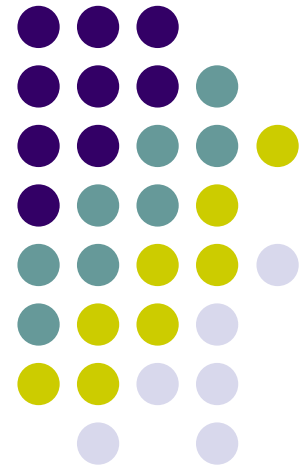



# Instance Transformation

- Start with unique object (a *symbol*)
- Each appearance of object in model is an *instance*
  - Must scale, orient, position
  - Defines instance transformation

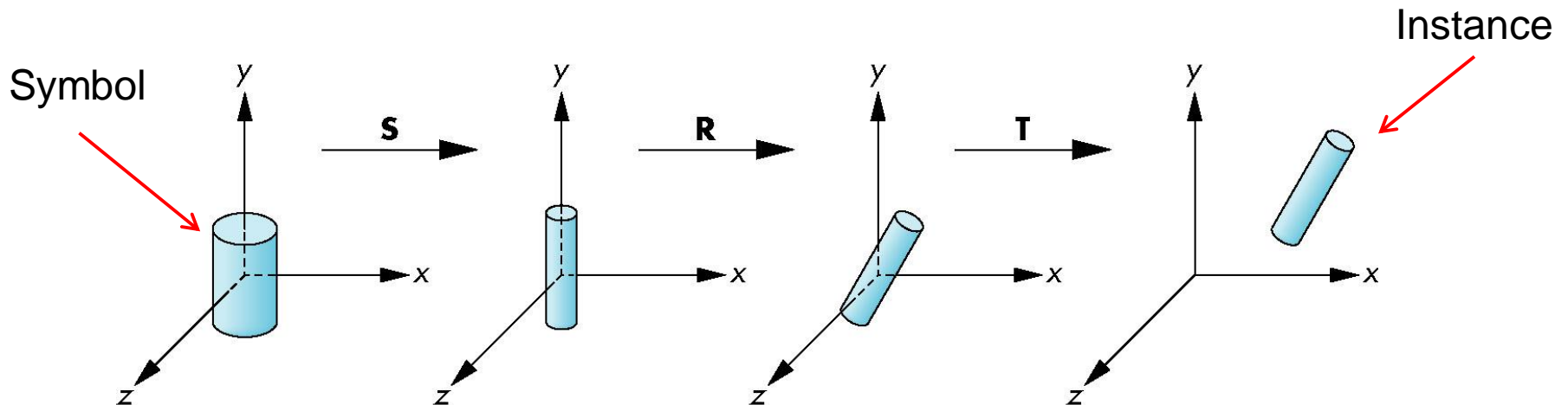

# Symbol-Instance Table

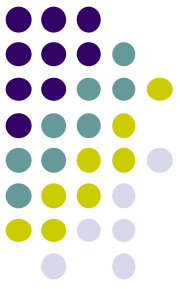

Can store **instances + instance transformations**

Symbol	Scale	Rotate	Translate
1	$s_{x'}, s_{y'}, s_{z'}$	$\theta_{x'}, \theta_{y'}, \theta_{z'}$	$d_{x'}, d_{y'}, d_{z'}$
2			
3			
1			
1			
·			
·			

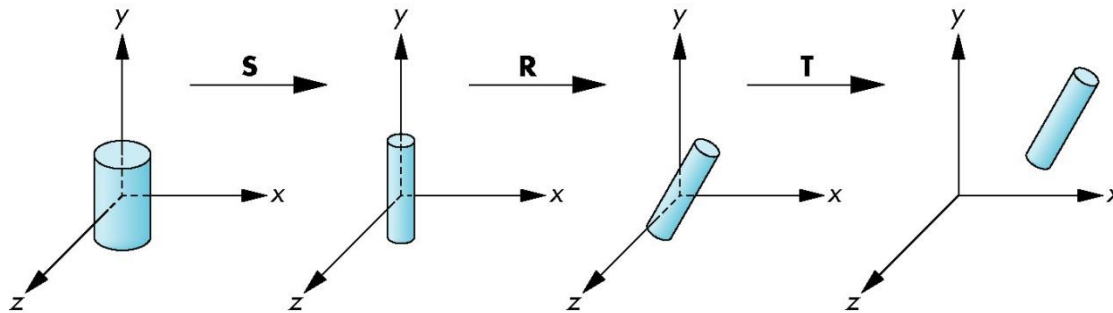

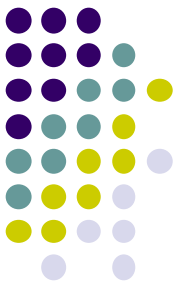

# Problems with Symbol-Instance Table

- Symbol-instance table does not show relationships between parts of model
- Consider model of car
  - Chassis (body) + 4 identical wheels
  - Two symbols

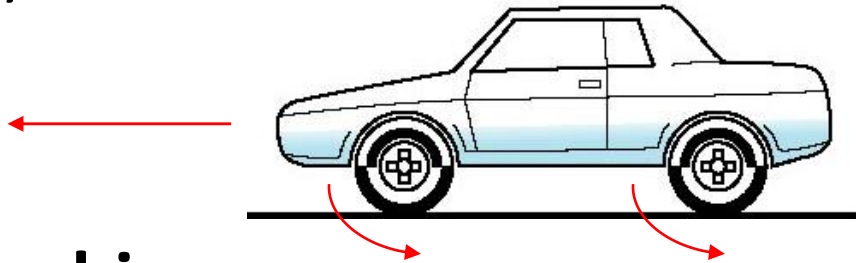

- **Relationships:**
  - Wheels connected to chassis
  - Chassis motion determined by rotational speed of wheels

# Structure Program Using Function Calls?

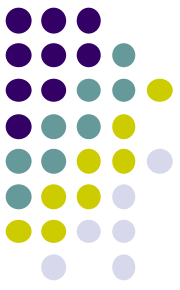

```
car (speed)
{
    chassis ()
    wheel (right_front) ;
    wheel (left_front) ;
    wheel (right_rear) ;
    wheel (left_rear) ;
}
```

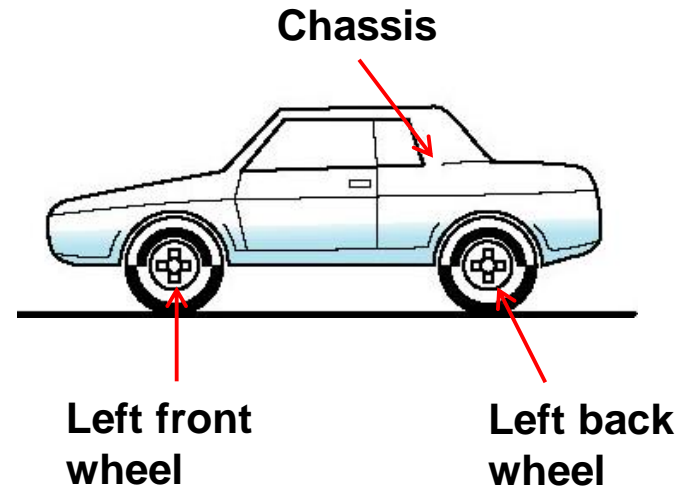

- Fails to show relationships between parts
- Explore graph representation

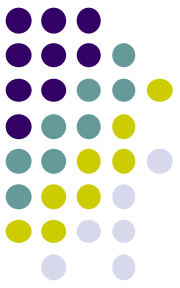

# Graphs

- Set of *nodes* + *edges (links)*
- **Edge** connects a pair of nodes
  - Directed or undirected
- **Cycle:** directed path that is a loop

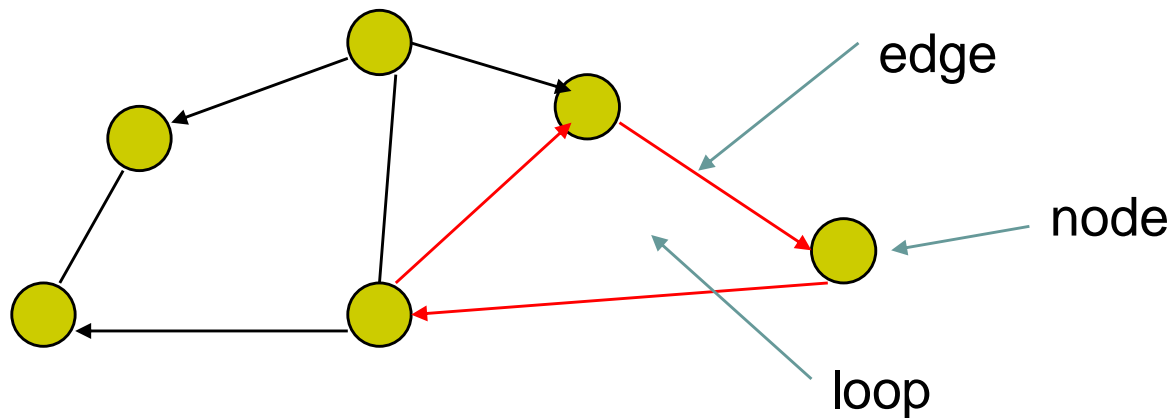

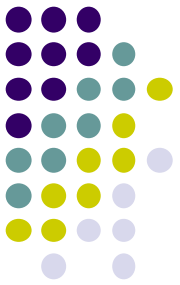

# Tree

- Graph in which each node (except root) has exactly one parent node
  - A parent may have multiple children
  - Leaf node: no children

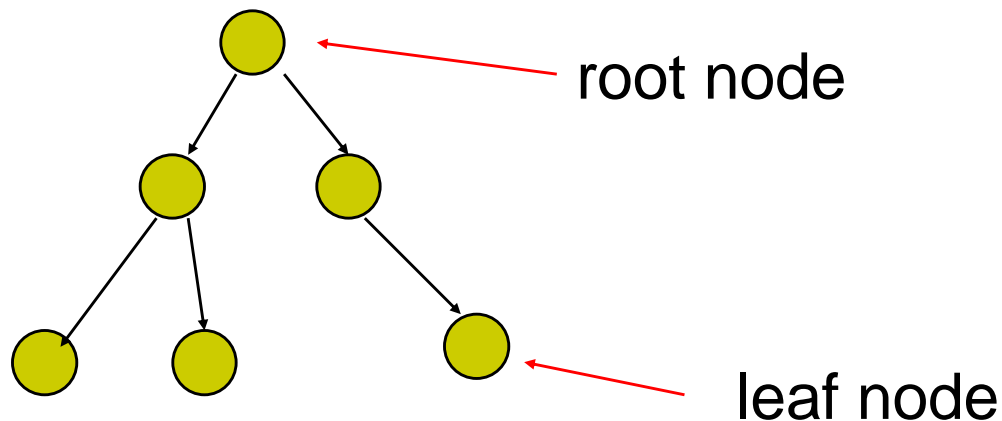

# Tree Model of Car

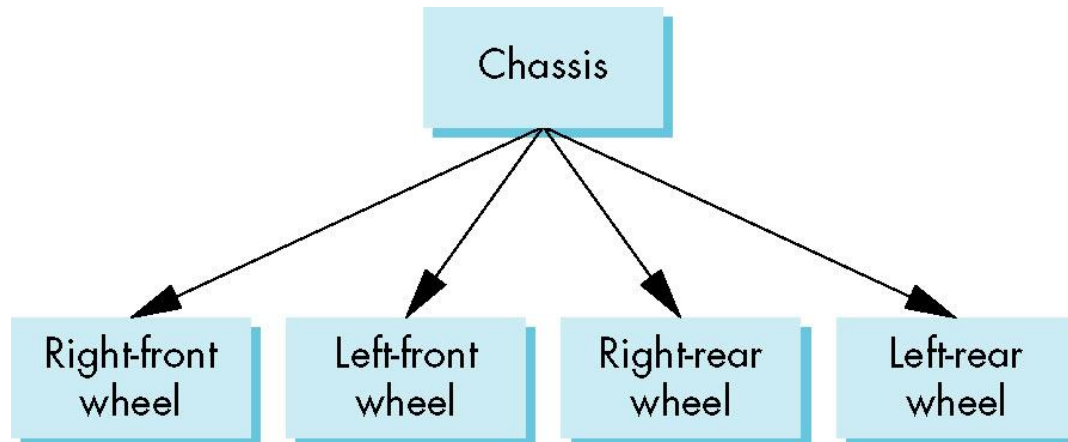
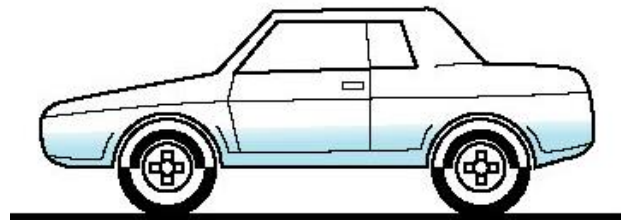
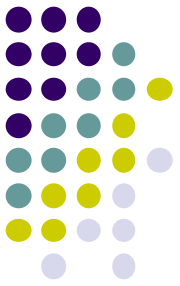





# Hierarchical Transforms

- **Robot arm:** Many small **connected** parts
- Attributes (position, orientation, etc) depend on each other

**A ROBOT HAMMER!**

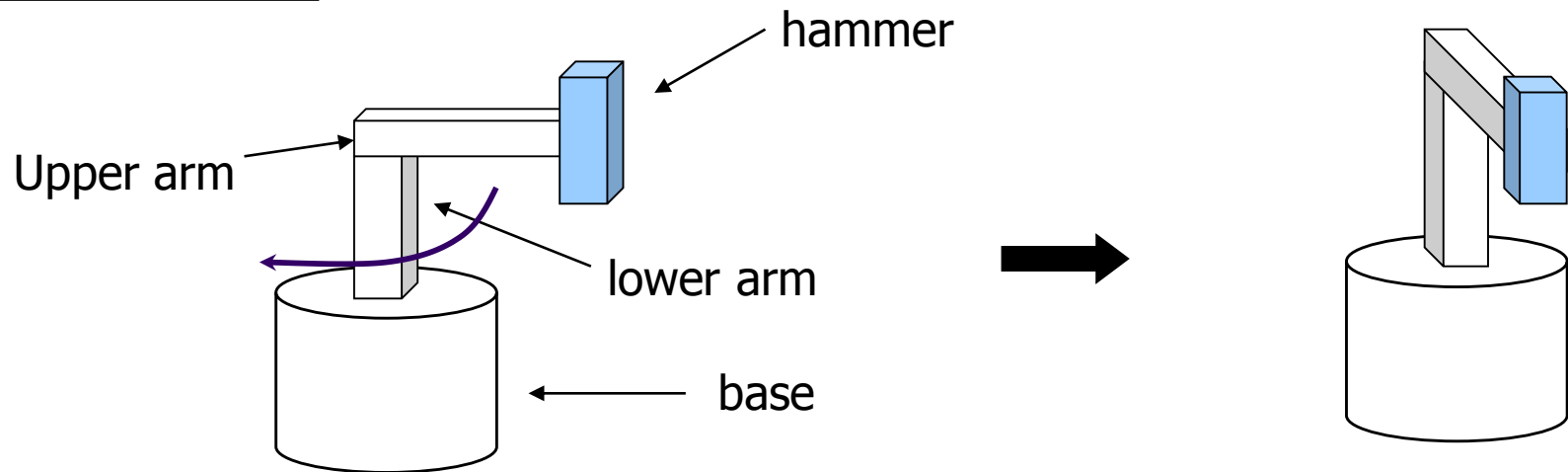



# Hierarchical Transforms

- Object dependency description using tree structure

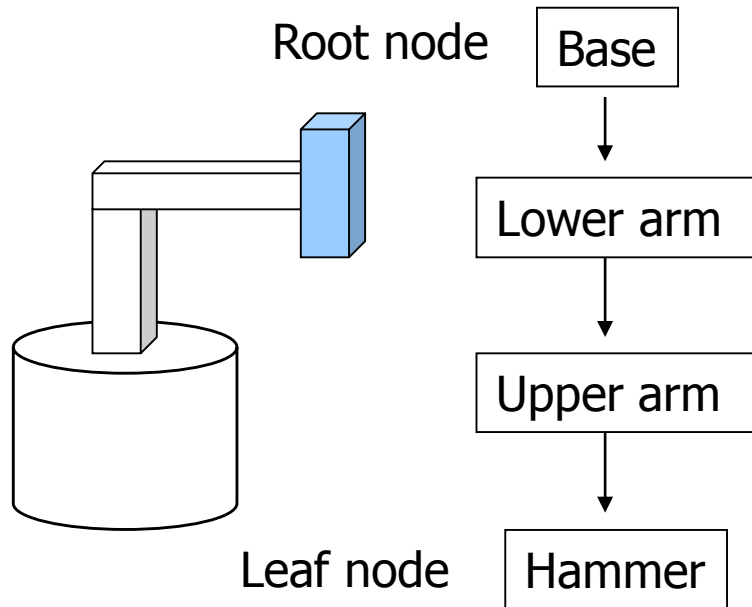

Object position and orientation can be affected by its parent, grand-parent, grand-grand-parent ... nodes

Hierarchical representation is known as a **Scene Graph**

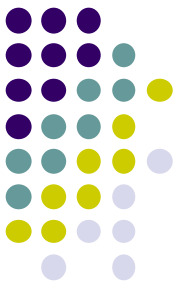

# Transformations

- Two ways to specify transformations:
  - **(1) Absolute transformation:** each part transformed independently (relative to origin)

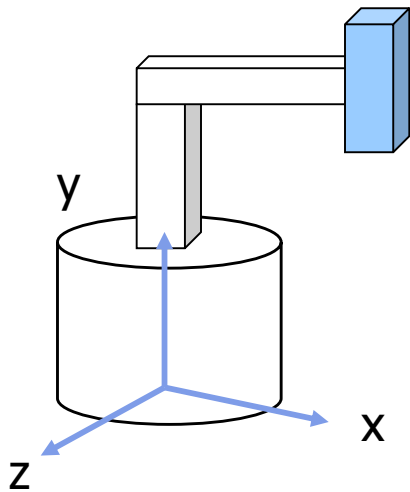

Translate the base by  $(5,0,0)$ ;  
Translate the lower arm by  $(5,0,0)$ ;  
Translate the upper arm by  $(5,0,0)$ ;  
...

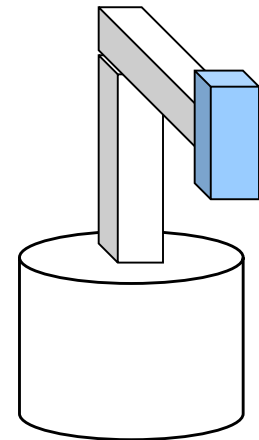
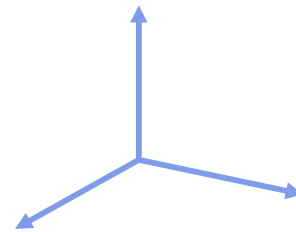



# Relative Transformation

A better (and easier) way:

(2) **Relative transformation:** Specify transformation for each object relative to its parent

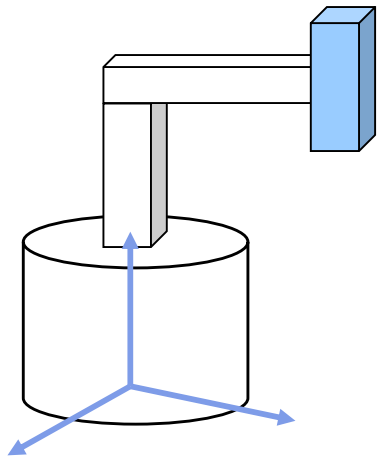

**Step 1: Translate base and its child nodes by (5,0,0);**

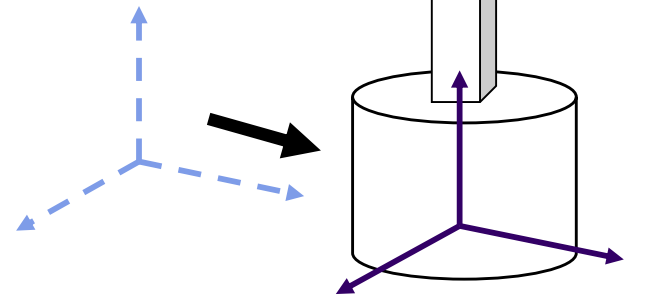

# Relative Transformation

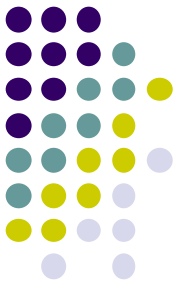

**Step 2: Rotate the lower arm and all its descendants relative to the base's local y axis by -90 degree**

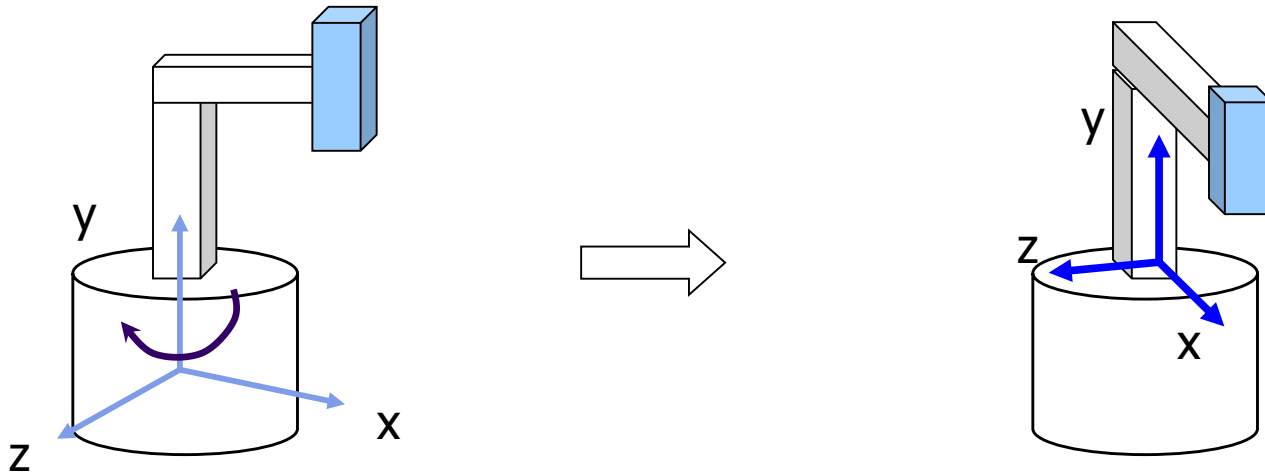



# Relative Transformation

- Relative transformation using scene graph

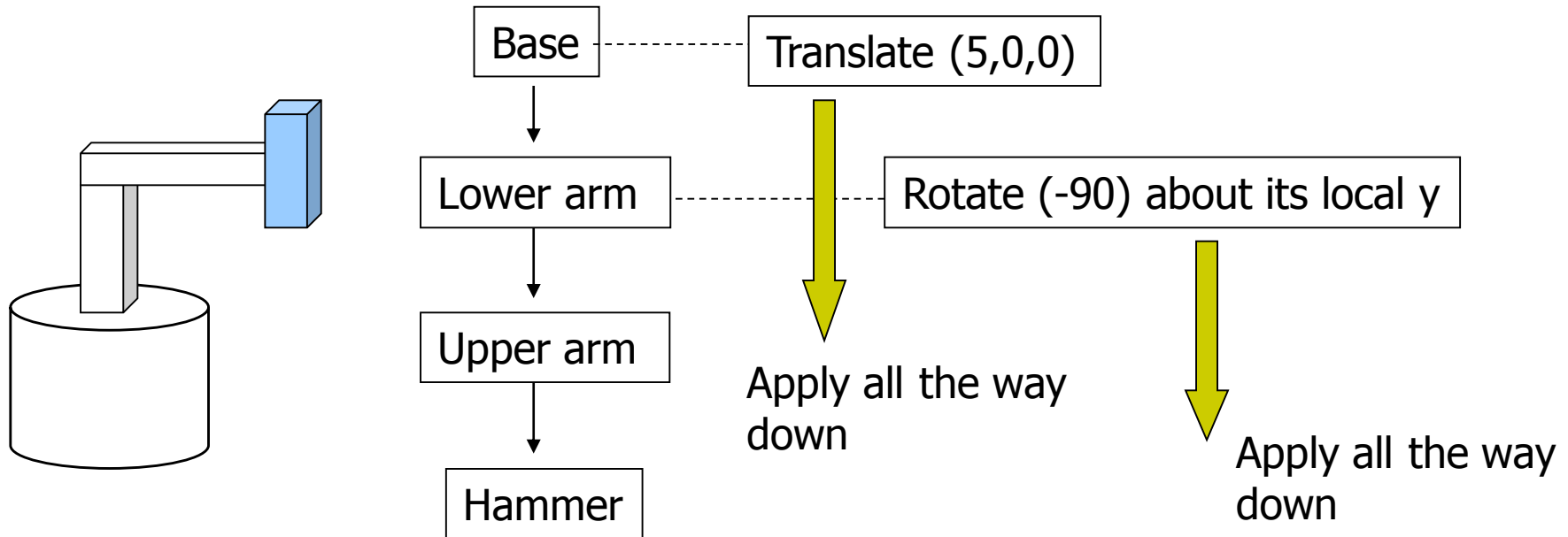

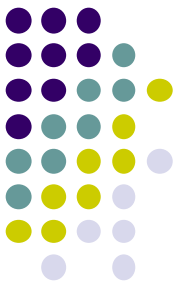

# Hierarchical Transforms Using OpenGL

- Translate base and all its descendants by (5,0,0)
- Rotate lower arm and its descendants by -90 degree about local y

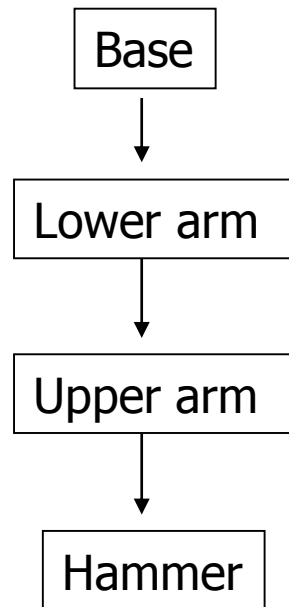
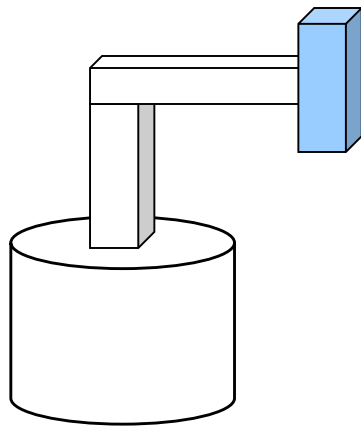

```
ctm = LoadIdentity();  
... // setup your camera  
ctm = ctm * Translatef(5,0,0);  
Draw_base();  
ctm = ctm * Rotatef(-90, 0, 1, 0);  
Draw_lower_arm();  
Draw_upper_arm();  
Draw_hammer();
```



# Hierarchical Modeling

- For large objects with many parts, need to transform **groups** of objects
- Need better tools

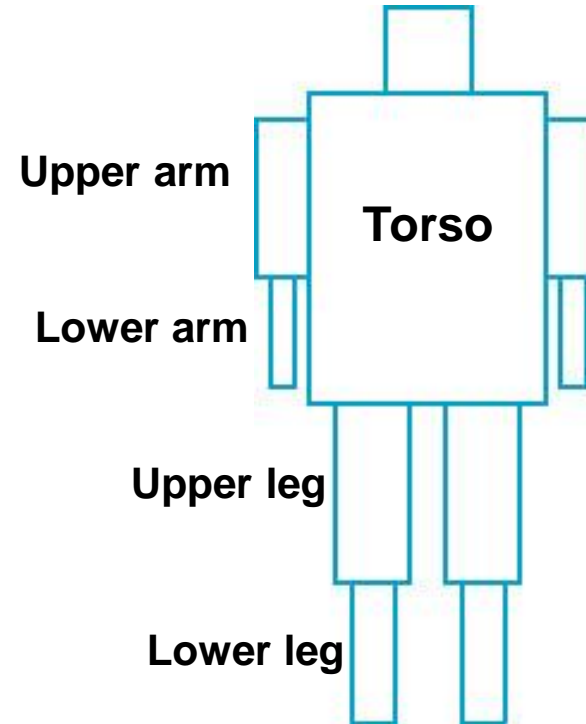



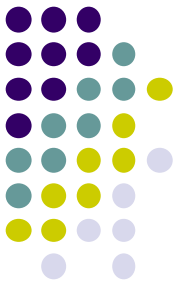

# Hierarchical Modeling

- Previous CTM had 1 level
- **Hierarchical modeling:** extend CTM to stack with multiple levels using linked list
- Manipulate stack levels using 2 operations
  - pushMatrix
  - popMatrix

Current top  
Of CTM stack

$$\begin{matrix} \longrightarrow & \begin{pmatrix} 1 & 0 & 0 & 0 \\ 0 & 2 & 0 & 0 \\ 0 & 0 & 3 & 0 \\ 0 & 0 & 0 & 1 \end{pmatrix} \end{matrix}$$



# PushMatrix

- **PushMatrix( )**: Save current modelview matrix (CTM) in stack
- Positions 1 & 2 in linked list **are same** after PushMatrix

*Before PushMatrix*

Current top  
Of CTM stack → 
$$\begin{pmatrix} 1 & 0 & 0 & 0 \\ 0 & 2 & 0 & 0 \\ 0 & 0 & 3 & 0 \\ 0 & 0 & 0 & 1 \end{pmatrix}$$



*After PushMatrix*

← Current top  
Of CTM stack 
$$\begin{pmatrix} 1 & 0 & 0 & 0 \\ 0 & 2 & 0 & 0 \\ 0 & 0 & 3 & 0 \\ 0 & 0 & 0 & 1 \end{pmatrix}$$



$$\begin{pmatrix} 1 & 0 & 0 & 0 \\ 0 & 2 & 0 & 0 \\ 0 & 0 & 3 & 0 \\ 0 & 0 & 0 & 1 \end{pmatrix}$$

Saved copy of  
matrix at CTM top



# PushMatrix

- Further Rotate, Scale, Translate affect only top matrix
- E.g. `ctm = ctm * Translate (3,8,6)`

*After PushMatrix*

$$\begin{pmatrix} 1 & 0 & 0 & 0 \\ 0 & 2 & 0 & 0 \\ 0 & 0 & 3 & 0 \\ 0 & 0 & 0 & 1 \end{pmatrix}$$



$$\begin{pmatrix} 1 & 0 & 0 & 3 \\ 0 & 1 & 0 & 8 \\ 0 & 0 & 1 & 6 \\ 0 & 0 & 0 & 1 \end{pmatrix}$$

← Translate(3,8,6) applied  
only to current top  
Of CTM stack

↓

$$\begin{pmatrix} 1 & 0 & 0 & 0 \\ 0 & 2 & 0 & 0 \\ 0 & 0 & 3 & 0 \\ 0 & 0 & 0 & 1 \end{pmatrix}$$

← Matrix in second position saved.  
Unaffected by Translate(3,8,6)



# PopMatrix

- **PopMatrix( )**: Delete position 1 matrix, position 2 matrix becomes top

*Before PopMatrix*

Current top  
Of CTM stack

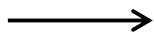

$$\begin{pmatrix} 1 & 5 & 4 & 0 \\ 0 & 2 & 2 & 0 \\ 0 & 6 & 3 & 0 \\ 0 & 0 & 0 & 1 \end{pmatrix}$$



$$\begin{pmatrix} 1 & 0 & 0 & 0 \\ 0 & 2 & 0 & 0 \\ 0 & 0 & 3 & 0 \\ 0 & 0 & 0 & 1 \end{pmatrix}$$

Delete this matrix

*After PopMatrix*

Current top  
Of CTM stack

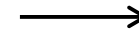

$$\begin{pmatrix} 1 & 0 & 0 & 0 \\ 0 & 2 & 0 & 0 \\ 0 & 0 & 3 & 0 \\ 0 & 0 & 0 & 1 \end{pmatrix}$$



# PopMatrix and PushMatrix Illustration

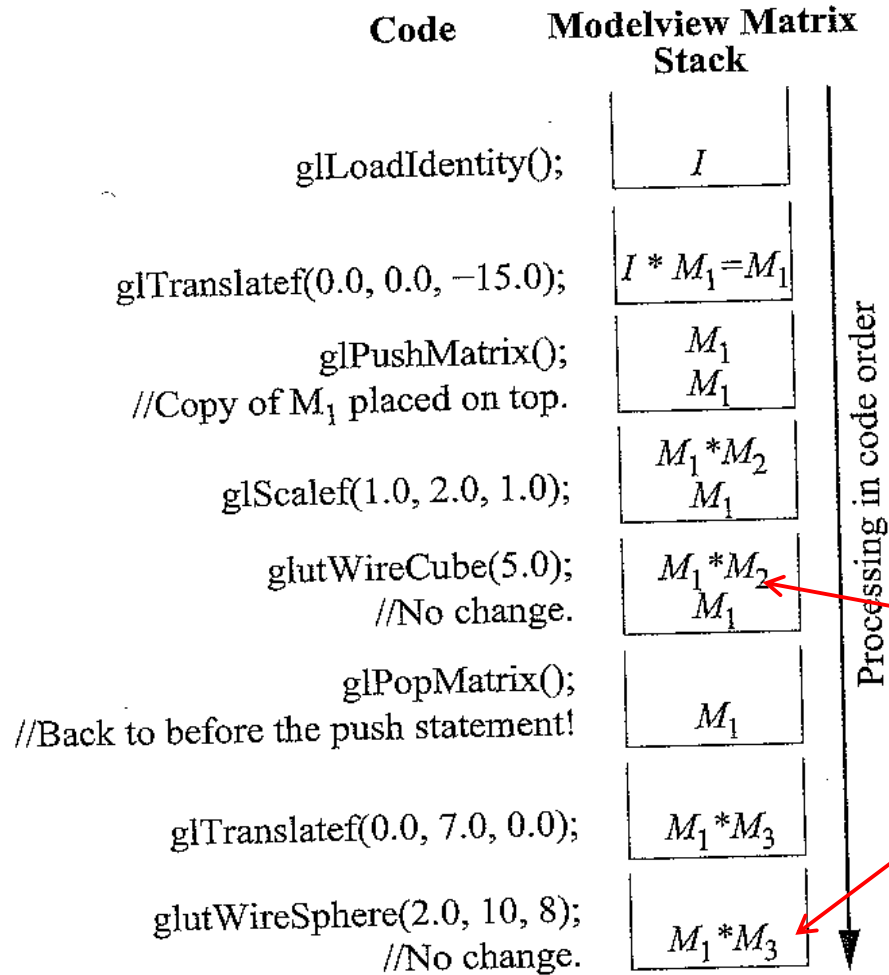

- **Note:** Diagram uses old `glTranslate`, `glScale`, etc commands
- We want same behavior though

Apply matrix at top of CTM to vertices of object created

**Ref:** Computer Graphics Through OpenGL by Guha

Figure 4.19: Transitions of the modelview matrix stack.

# Humanoid Figure

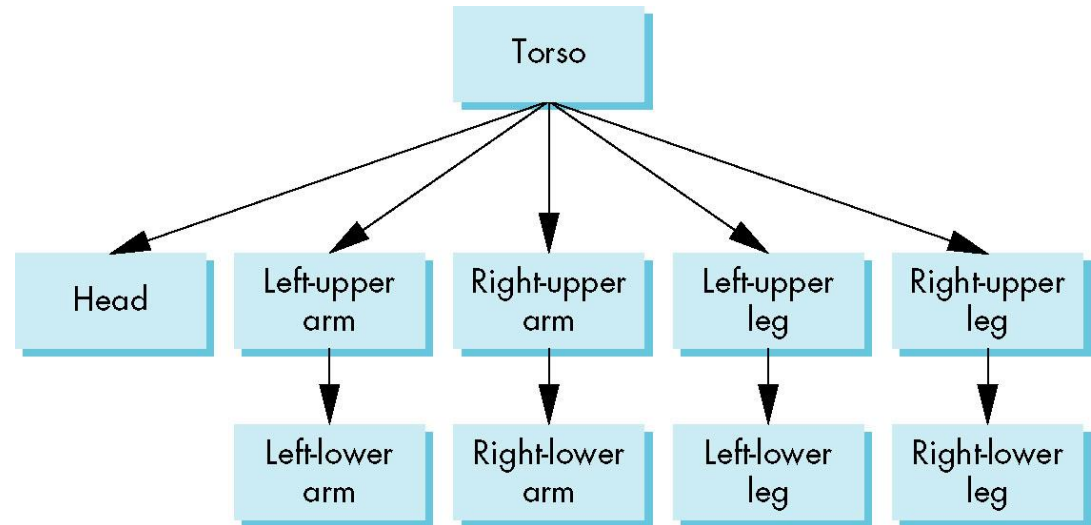
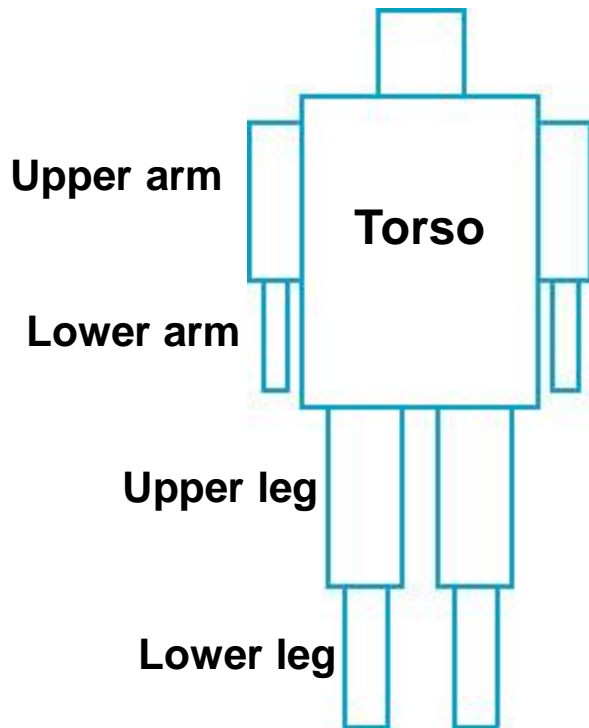
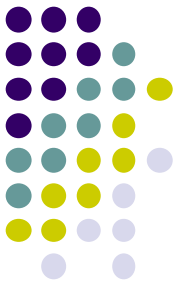

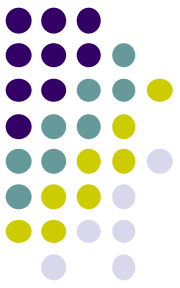

# Building the Model

- Draw each part as a function
  - `torso()`
  - `left_upper_arm()`, etc
- **Transform Matrices:** transform of node wrt its parent
  - $M_{lla}$  positions left lower arm with respect to left upper arm
- Stack based traversal (push, pop)

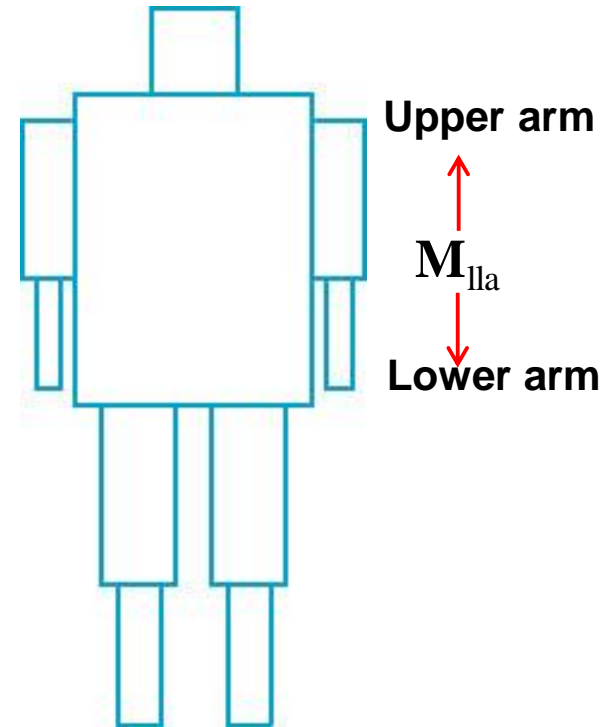

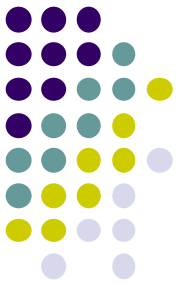

# Draw Humanoid using Stack

Torso

```
figure() {  
    PushMatrix() ← save present model-view matrix  
    torso(); ← draw torso  
}
```





# Draw Humanoid using Stack

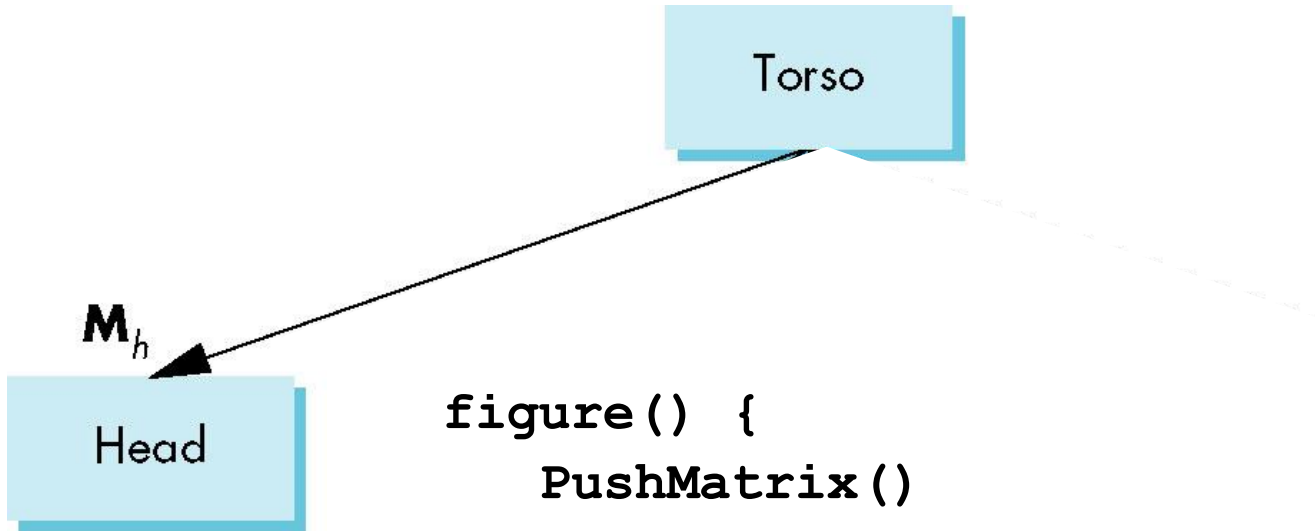

```
figure() {  
  PushMatrix()  
  torso();  
  Rotate (...);  
  head();  
}
```

$(M_h)$  Transformation of head  
Relative to torso

draw head



# Draw Humanoid using Stack

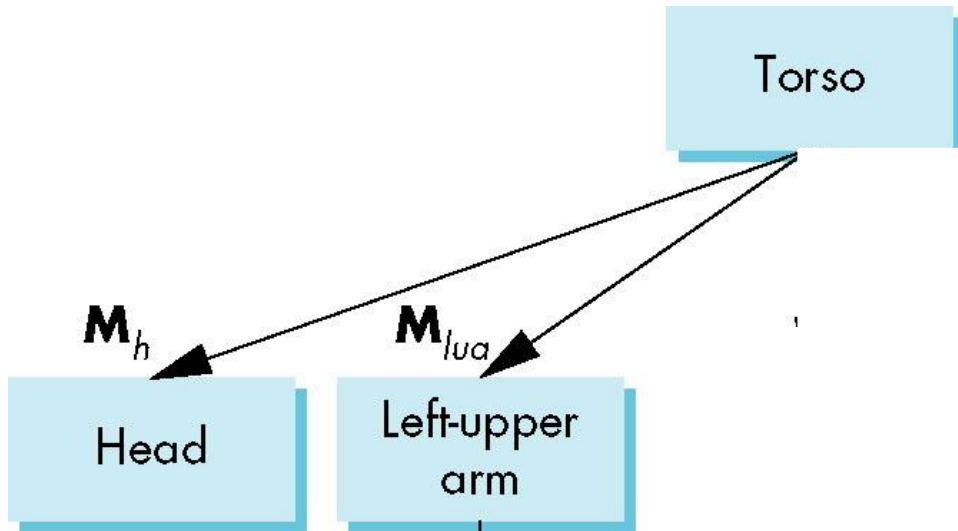

```
PushMatrix()
torso();
Rotate (...);
head();
PopMatrix();
PushMatrix();
Translate (...);
Rotate (...);
left_upper_arm();
.....
// rest of code()
```

Go back to torso matrix, and save it again →

( $M_{lua}$ ) Transformation(s) of left upper arm relative to torso →

draw left-upper arm →

# Complete Humanoid Tree with Matrices

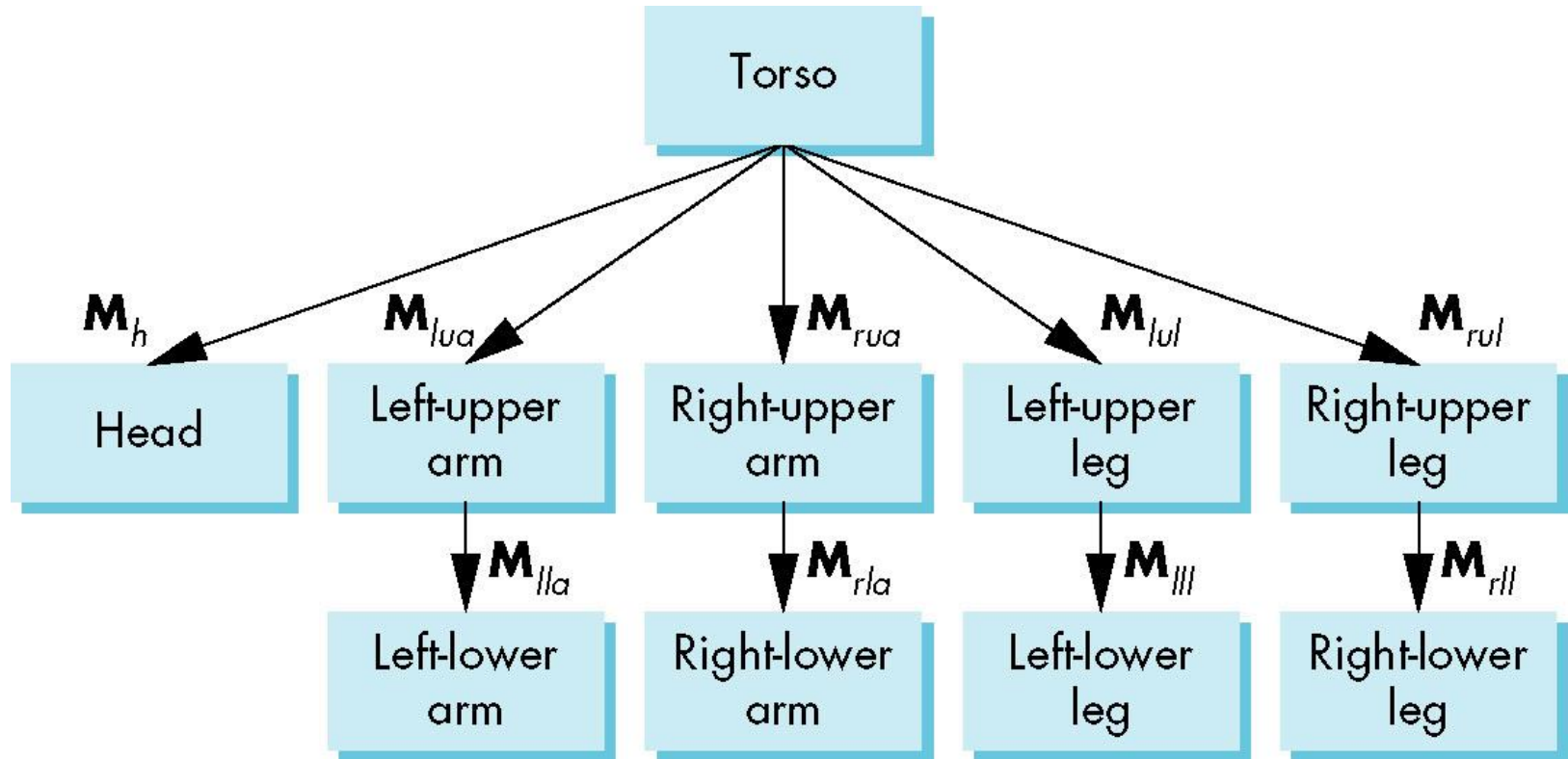
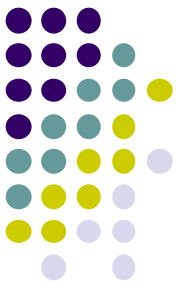

**Scene graph of Humanoid Robot**



# VRML

- Scene graph introduced by SGI Open Inventor
- Used in many graphics applications (Maya, etc)
- Virtual Reality Markup Language
  - Scene graph representation of virtual worlds on Web
  - Scene parts can be distributed across multiple web servers
  - Implemented using OpenGL

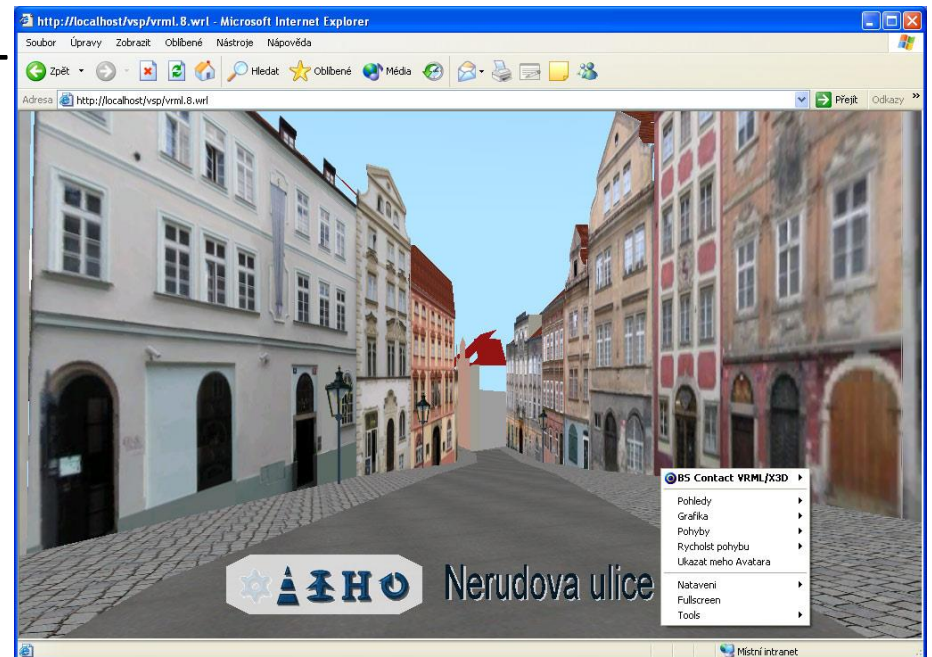

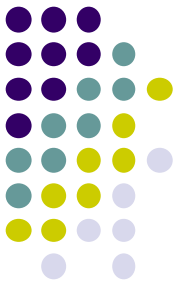

# References

- Angel and Shreiner, Interactive Computer Graphics (6<sup>th</sup> edition), Chapter 8