

# Computer Graphics (CS 543)

## Lecture 4a: Building 3D Models

---

Prof Emmanuel Agu

*Computer Science Dept.  
Worcester Polytechnic Institute (WPI)*

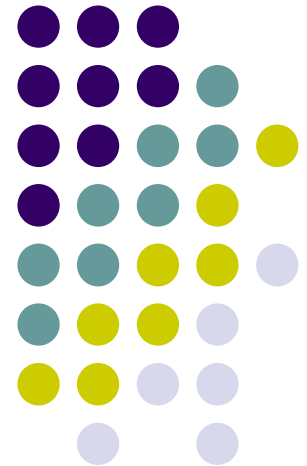

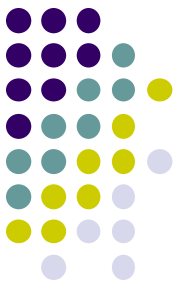

# 3D Applications

- **2D points:**  $(x,y)$  coordinates
- **3D points:** have  $(x,y,z)$  coordinates

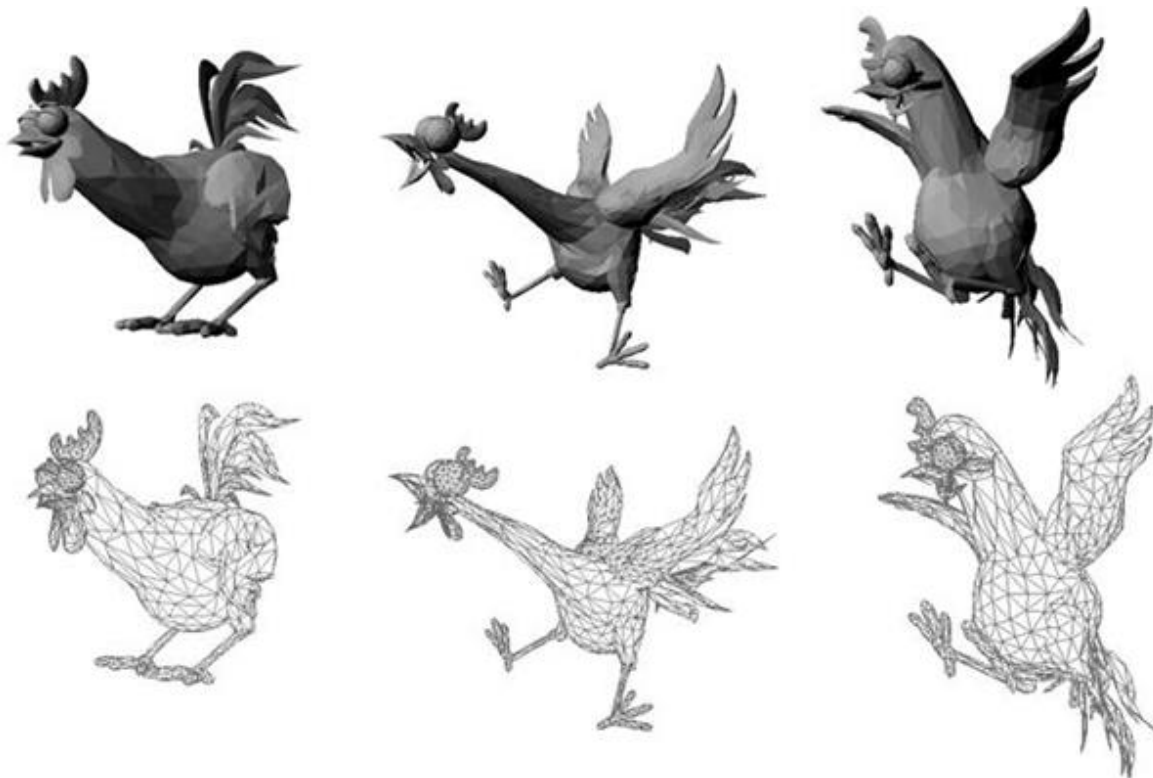



# Setting up 3D Applications: Main Steps

- Programming 3D similar to 2D
  1. Load representation of 3D object into data structure

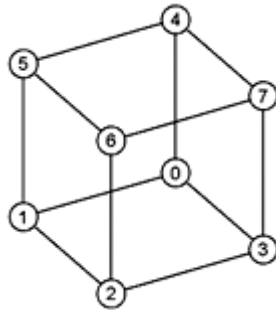

Each vertex has (x,y,z) coordinates.  
Store as **vec3** NOT **vec2**

2. Draw 3D object
3. **Set up Hidden surface removal:** Correctly determine order in which primitives (triangles, faces) are rendered (e.g Blocked faces **NOT** drawn)



# 3D Coordinate Systems

- Vertex  $(x,y,z)$  positions specified on coordinate system
- OpenGL uses **right hand coordinate system**

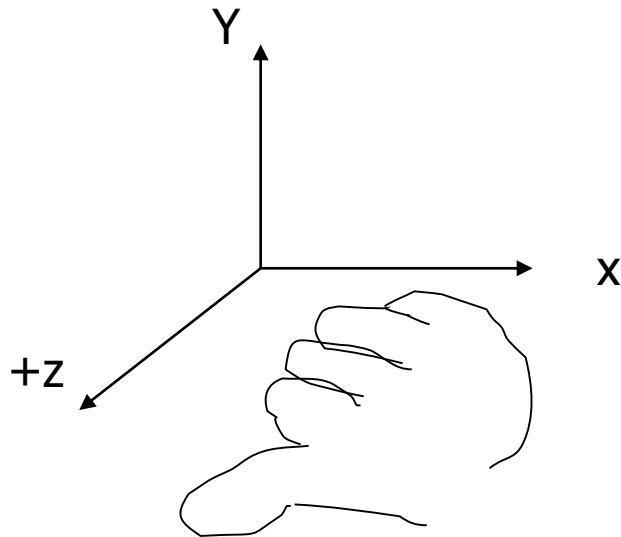

**Right hand coordinate system**  
Tip: sweep fingers x-y: thumb is z

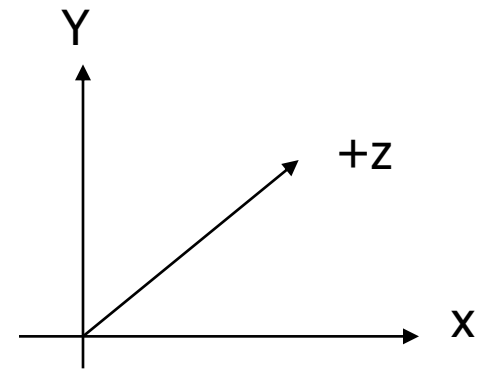

**Left hand coordinate system**  
• Not used in OpenGL

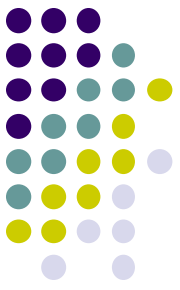

# Generating 3D Models: GLUT Models

- Make GLUT 3D calls in **OpenGL program** to generate vertices describing different shapes (Restrictive?)
- Two types of GLUT models:
  - Wireframe Models
  - Solid Models

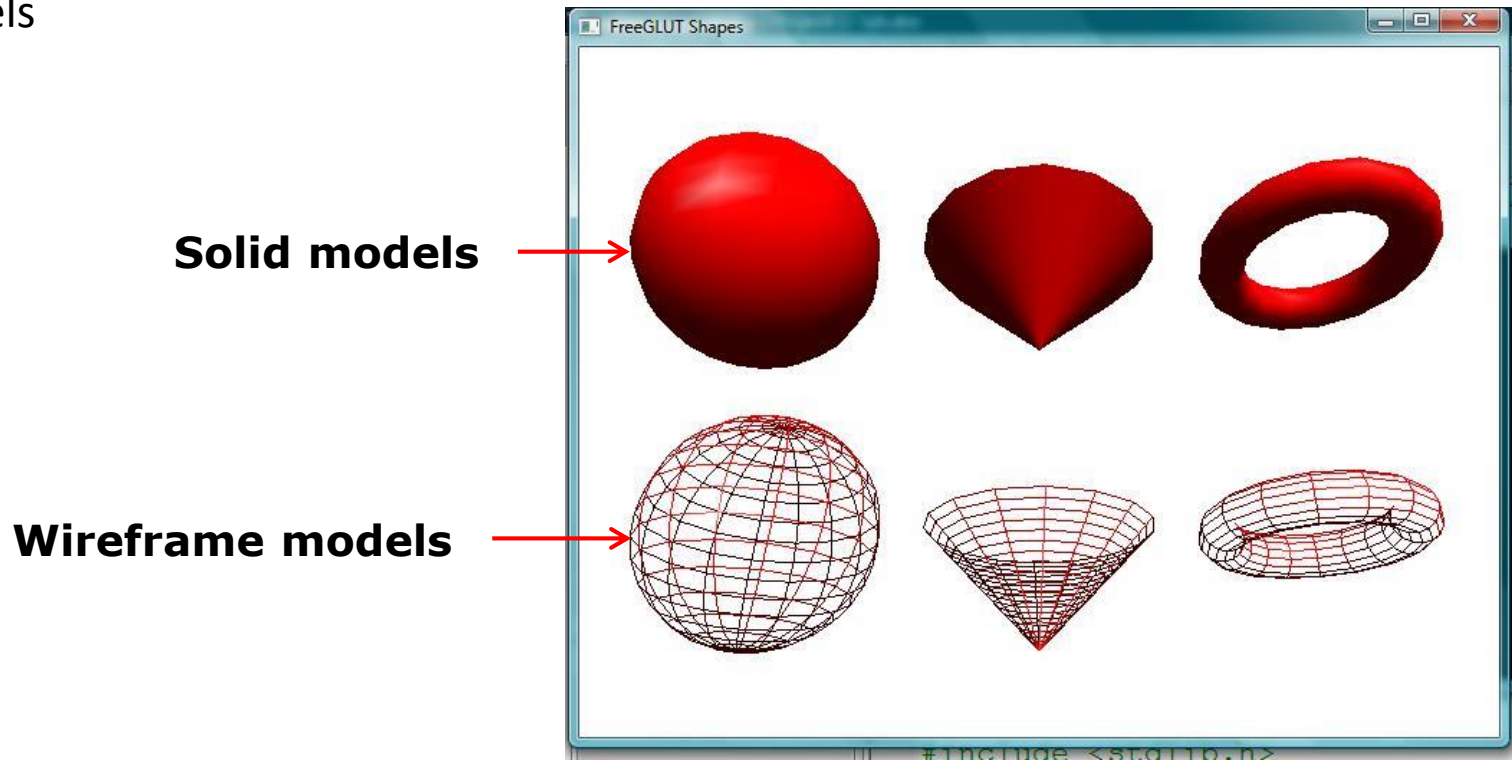



# 3D Modeling: GLUT Models

- Basic Shapes
  - **Cone:** `glutWireCone()`, `glutSolidCone()`
  - **Sphere:** `glutWireSphere()`, `glutSolidSphere()`
  - **Cube:** `glutWireCube()`, `glutSolidCube()`
- More advanced shapes:
  - Newell Teapot: (symbolic)
  - Dodecahedron, Torus

**Newell Teapot**

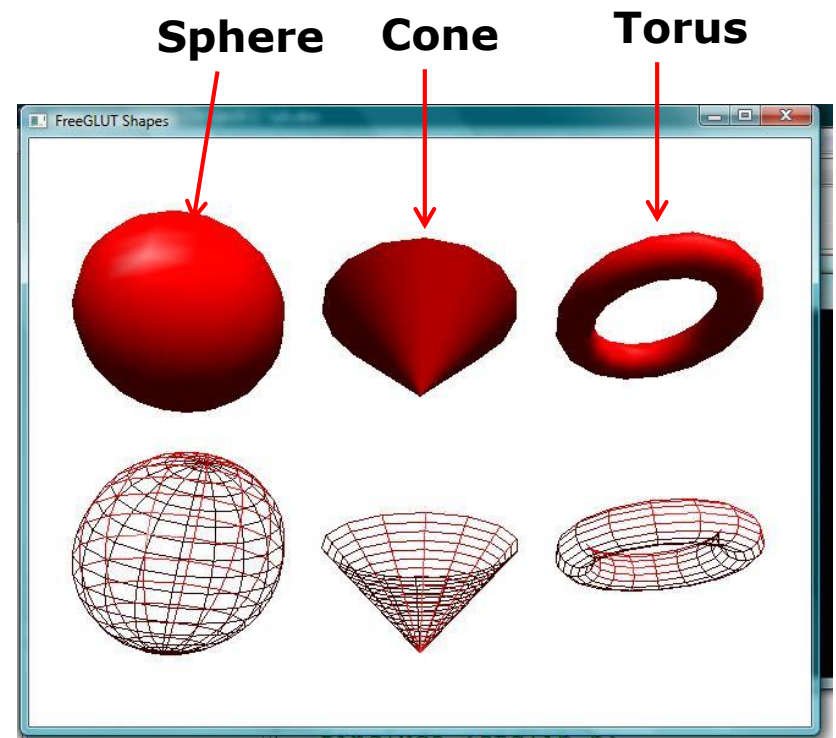
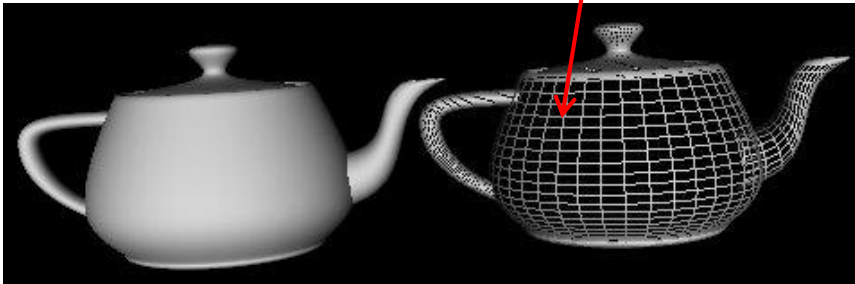

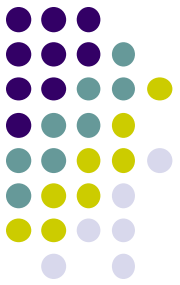

# 3D Modeling: GLUT Models

- Glut functions under the hood
  - generate sequence of points that define a shape
  - Generated vertices and faces passed to OpenGL for rendering
- **Example:** `glutWireCone` generates sequence of vertices, and faces defining `cone` and connectivity

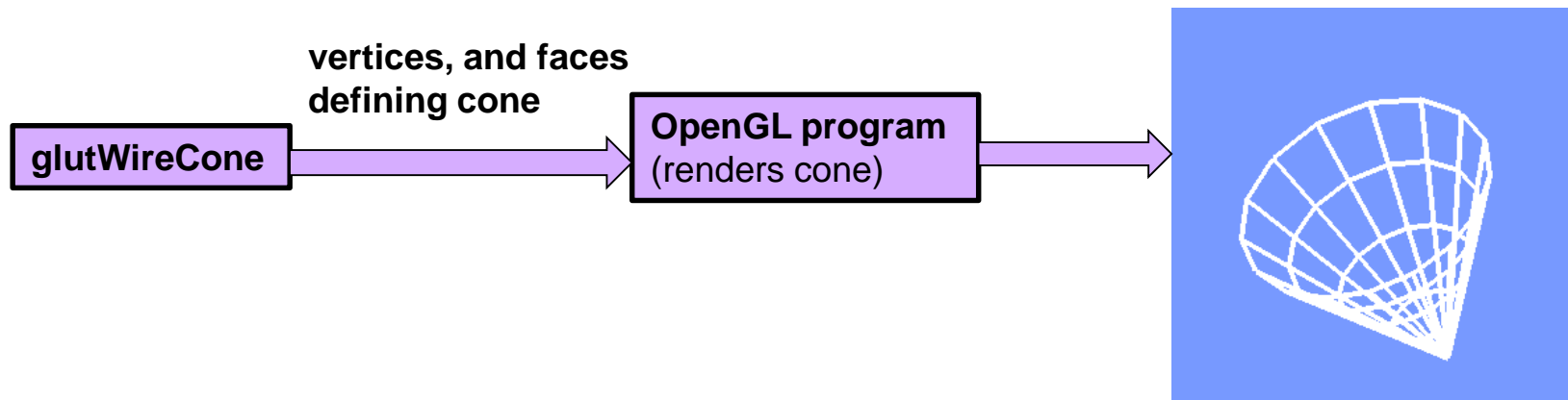

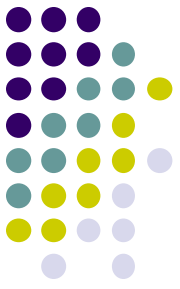

# Polygonal Meshes

- Modeling with GLUT shapes (cube, sphere, etc) too restrictive
- Difficult to approach realism. E.g. model a horse
- Preferred way is using polygonal meshes:
  - Collection of polygons, or faces, that form “skin” of object
  - More flexible, represents complex surfaces better
  - Examples:
    - Human face
    - Animal structures
    - Furniture, etc

**Each face of mesh  
is a polygon**

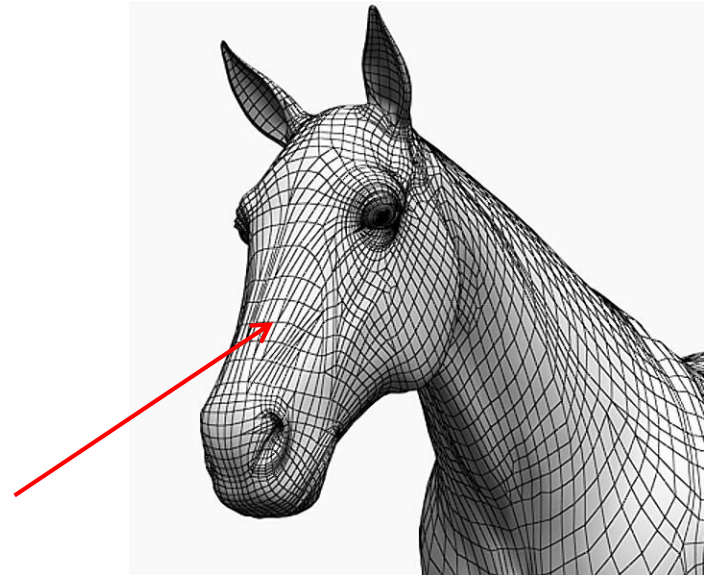



# Polygonal Meshes

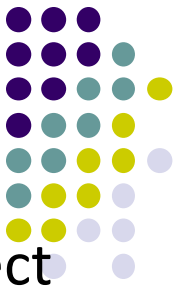

- Mesh = sequence of polygons forming thin skin around object
- OpenGL good at drawing polygons, triangles
- Meshes now standard in graphics
- Simple meshes exact. (e.g barn)
- Complex meshes approximate (e.g. human face)

# Same Mesh at Different Resolutions

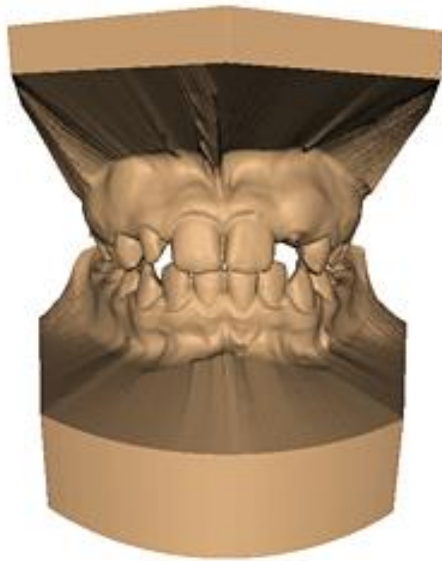

**Original: 424,000  
triangles**

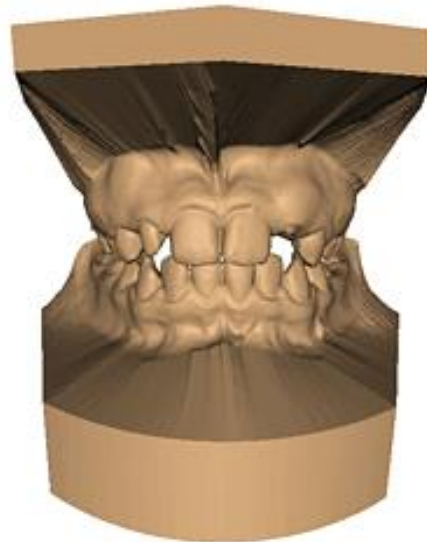

**60,000 triangles  
(14%).**



**1000 triangles  
(0.2%)**

**(courtesy of Michael Garland and Data courtesy of Iris Development.)**



# Representing a Mesh

- Consider a mesh

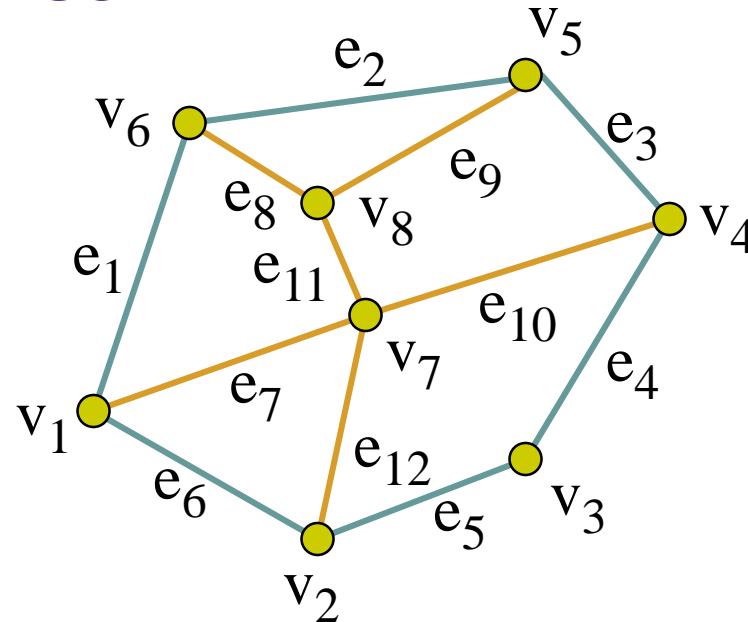

- There are 8 vertices and 12 edges
  - 5 interior polygons
  - 6 interior (shared) edges (shown in orange)
- Each vertex has a location  $v_i = (x_i \ y_i \ z_i)$



# Simple Representation

- Define each polygon by (x,y,z) locations of its vertices
- OpenGL code

```
vertex[i]    = vec3(x1, y1, z1);  
vertex[i+1]  = vec3(x6, y6, z6);  
vertex[i+2]  = vec3(x7, y7, z7);  
i+=3;
```

# Issues with Simple Representation

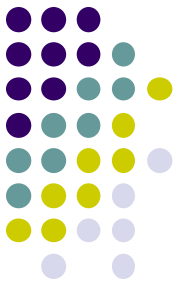

- Declaring face f1

```
vertex[i] = vec3(x1, y1, z1);  
vertex[i+1] = vec3(x7, y7, z7);  
vertex[i+2] = vec3(x8, y8, z8);  
vertex[i+3] = vec3(x6, y6, z6);
```

- Declaring face f2

```
vertex[i] = vec3(x1, y1, z1);  
vertex[i+1] = vec3(x2, y2, z2);  
vertex[i+2] = vec3(x7, y7, z7);
```

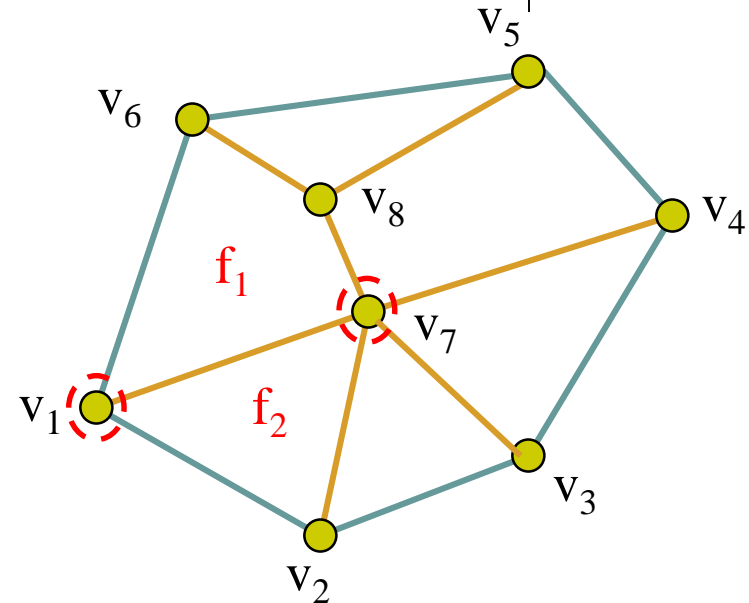

- Inefficient and unstructured

- **Repeats:** vertices **v1 and v7 repeated** while declaring f1 and f2
- Shared vertices shared declared multiple times
- Delete vertex? Move vertex? Search for all occurrences of vertex

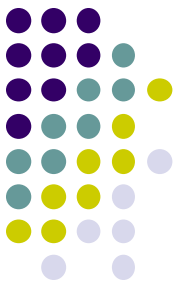

# Geometry vs Topology

- **Geometry:**  $(x,y,z)$  locations of the vertices
- **Topology:** How vertices and edges are connected
- Good data structures separate **geometry** from **topology**
- **Example:**
  - A polygon is **ordered list** of vertices
  - An edge connects successive pairs of vertices
- Topology holds even if geometry changes (vertex moves)

Example: even if we move  $(x,y,z)$  location of  $v_1$ ,  $v_1$  still connected to  $v_6$ ,  $v_7$  and  $v_2$

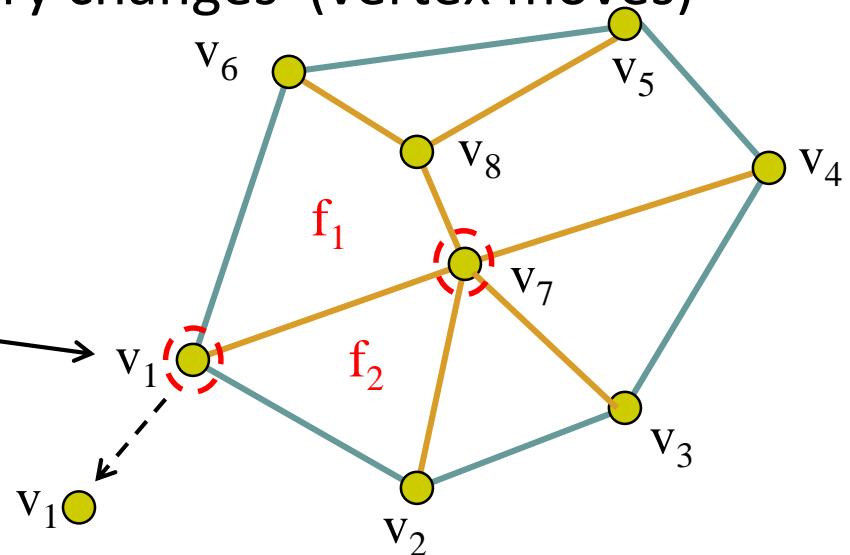



# Polygon Traversal Convention

- **Convention:** traverse vertices **counter-clockwise** around normal
- Focus on direction of traversal
  - Orders  $\{v_1, v_0, v_3\}$  and  $\{v_3, v_2, v_1\}$  are same (*ccw*)
  - Order  $\{v_1, v_2, v_3\}$  is different (*clockwise*)
- **Normal vector:** Direction each polygon is facing

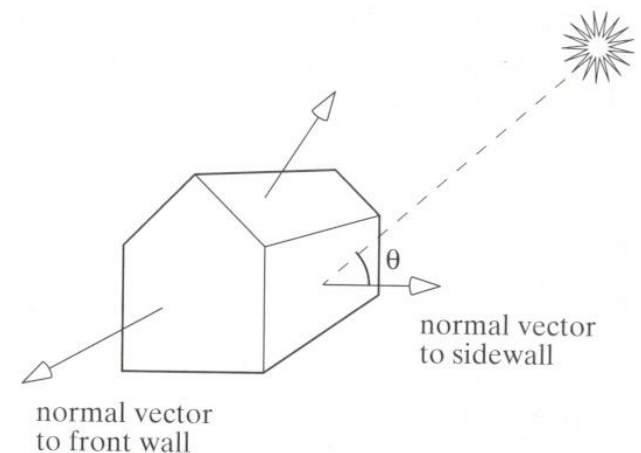
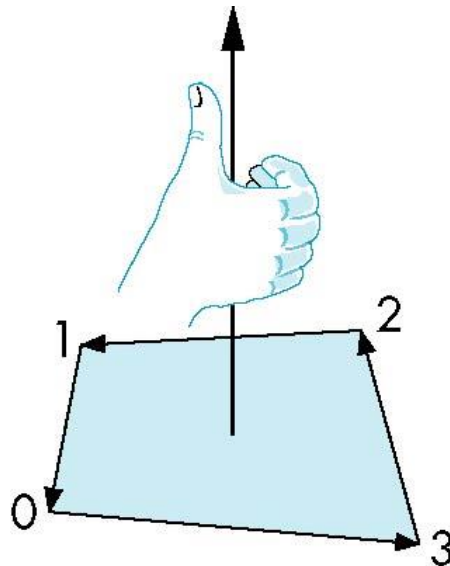
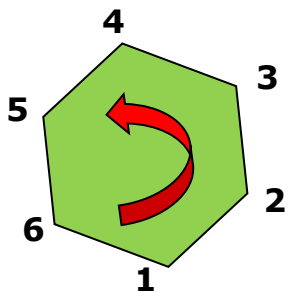

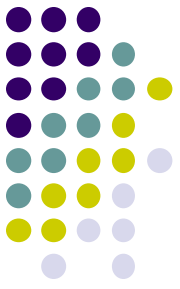

# Vertex Lists

- **Vertex list:** (x,y,z) of vertices (its geometry) are put in array
- Use pointers from vertices into vertex list
- **Polygon list:** vertices connected to each polygon (face)

**Topology** example: Polygon P1 of mesh is connected to vertices (v1,v7,v6)

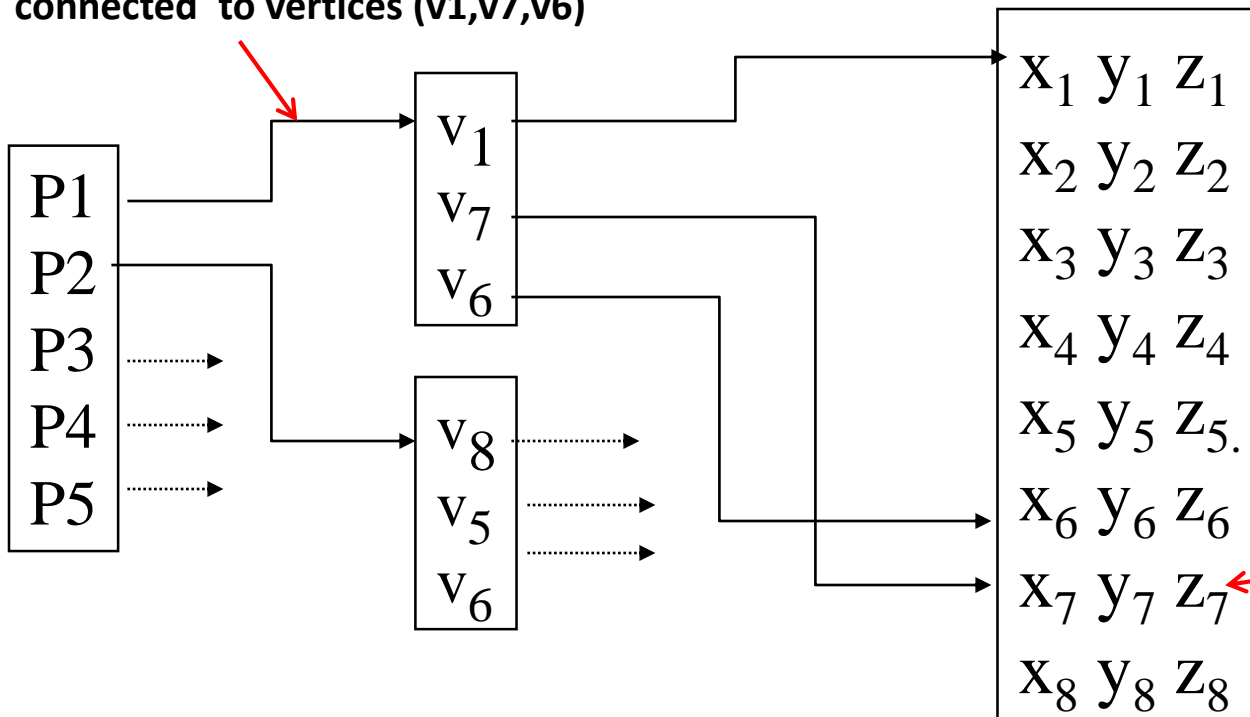

**Geometry** example:  
Vertex v7 coordinates are (x7,y7,z7).  
Note: If v7 moves, changed once in vertex list



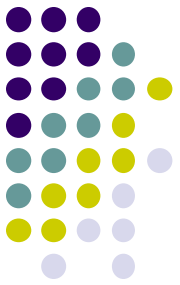

# Vertex List Issue: Shared Edges

- Vertex lists draw filled polygons correctly
- If each polygon is drawn by its edges, shared edges are drawn twice

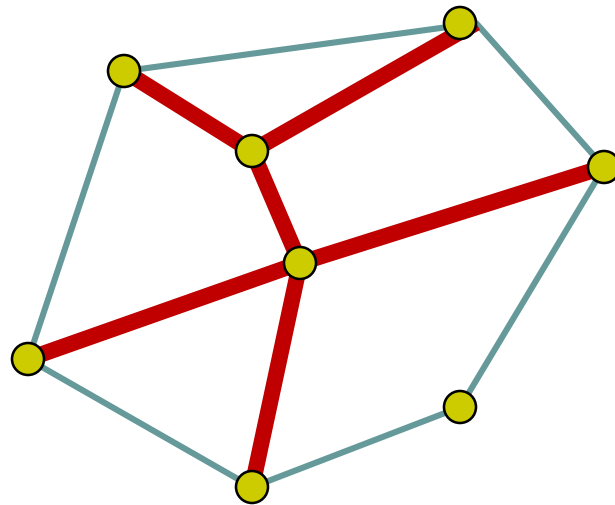

- **Alternatively:** Can store mesh by *edge list*

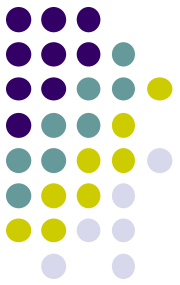

# Edge List

Simply draw each edges once  
**E.g** e1 connects v1 and v6

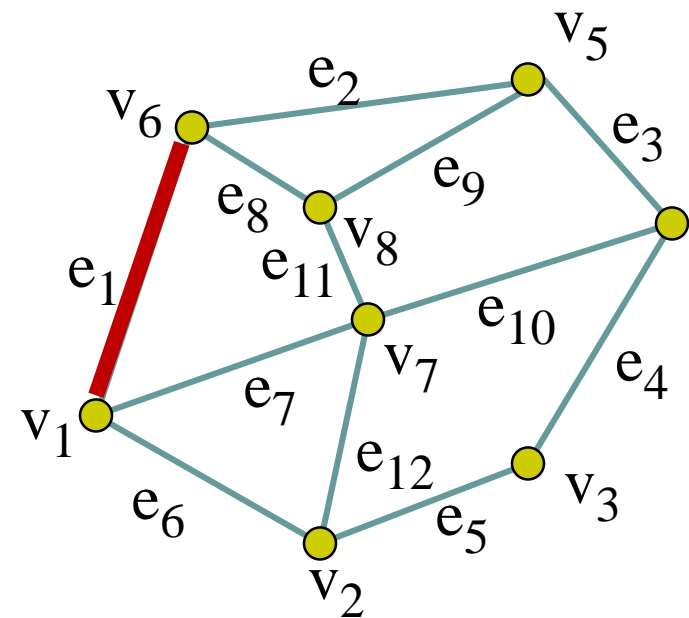
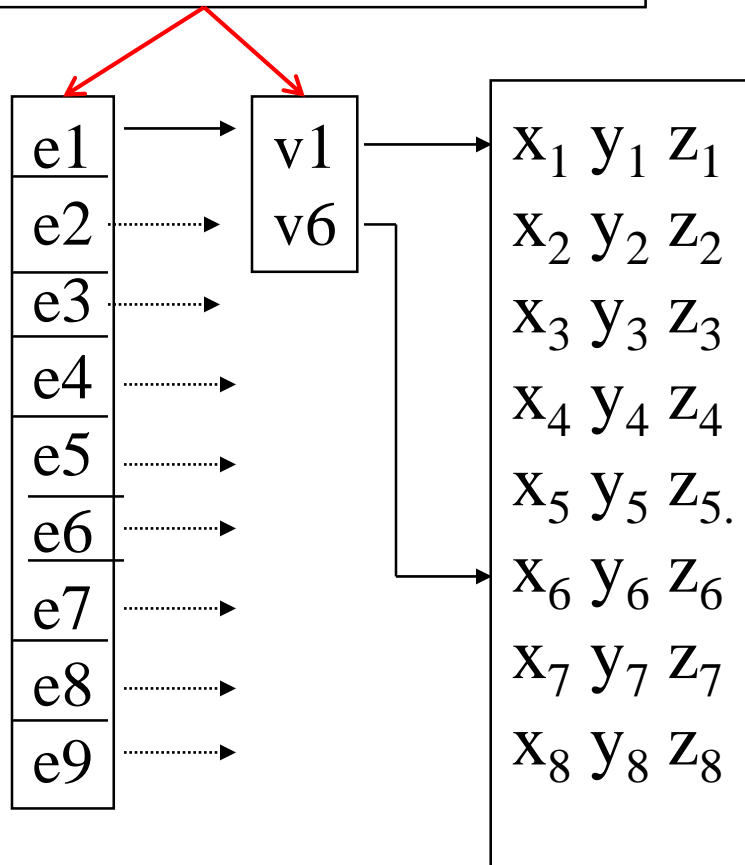

**Note** polygons are not represented



# Vertex Attributes

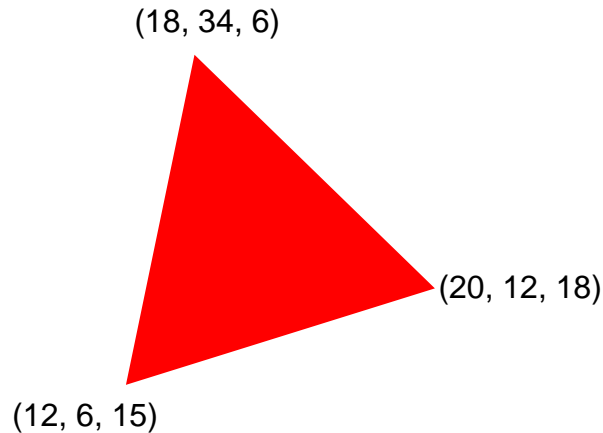

- Vertices can have attributes
  - Position (x, y, z) E.g (20, 12, 18)
  - Color (R,G,B) E.g. (1,0,0 ) or (red)
  - Normal (x,y,z)
  - Texture coordinates



# Vertex Attributes

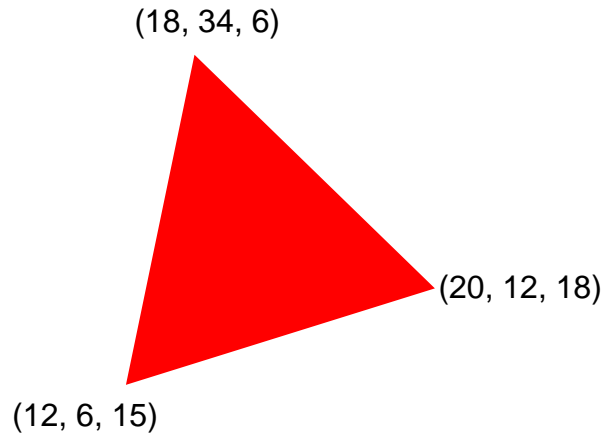

- Store vertex attributes in **single** Array (array of structures)
- **Later:** pass array to OpenGL, specify attributes, order, position using **glVertexAttribPointer**

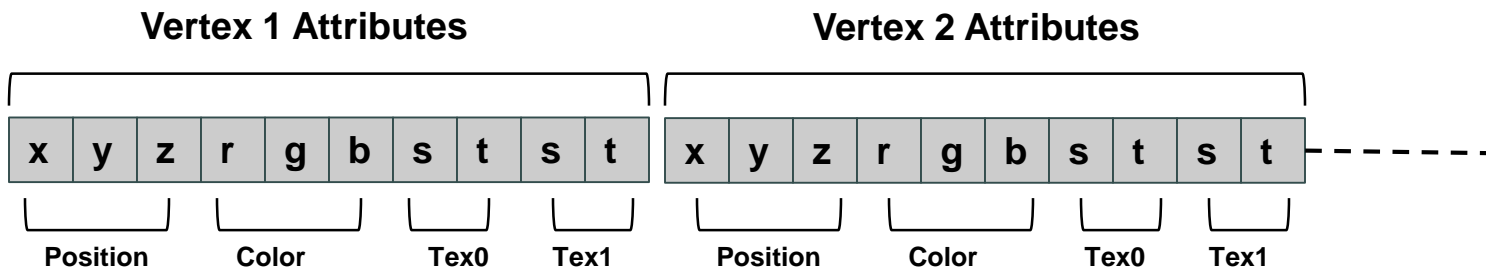



# Declaring Array of Vertex Attributes

- Consider the following array of vertex attributes

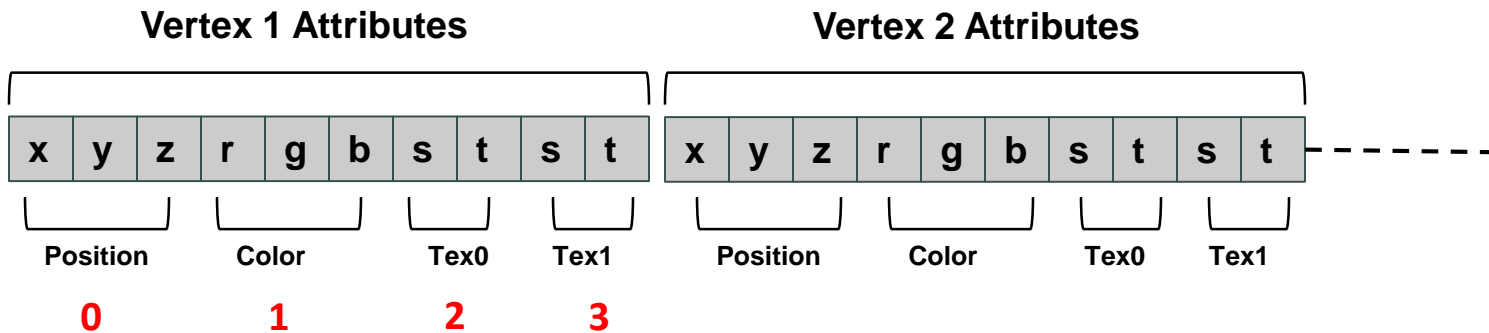

- So we can define attribute positions (per vertex)

```
#define VERTEX_POS_INDEX                   0
#define VERTEX_COLOR_INDEX               1
#define VERTEX_TEXCOORD0_INDX           2
#define VERTEX_TEXCOORD1_INDX           3
```



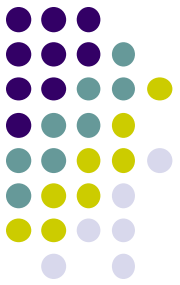

# Declaring Array of Vertex Attributes

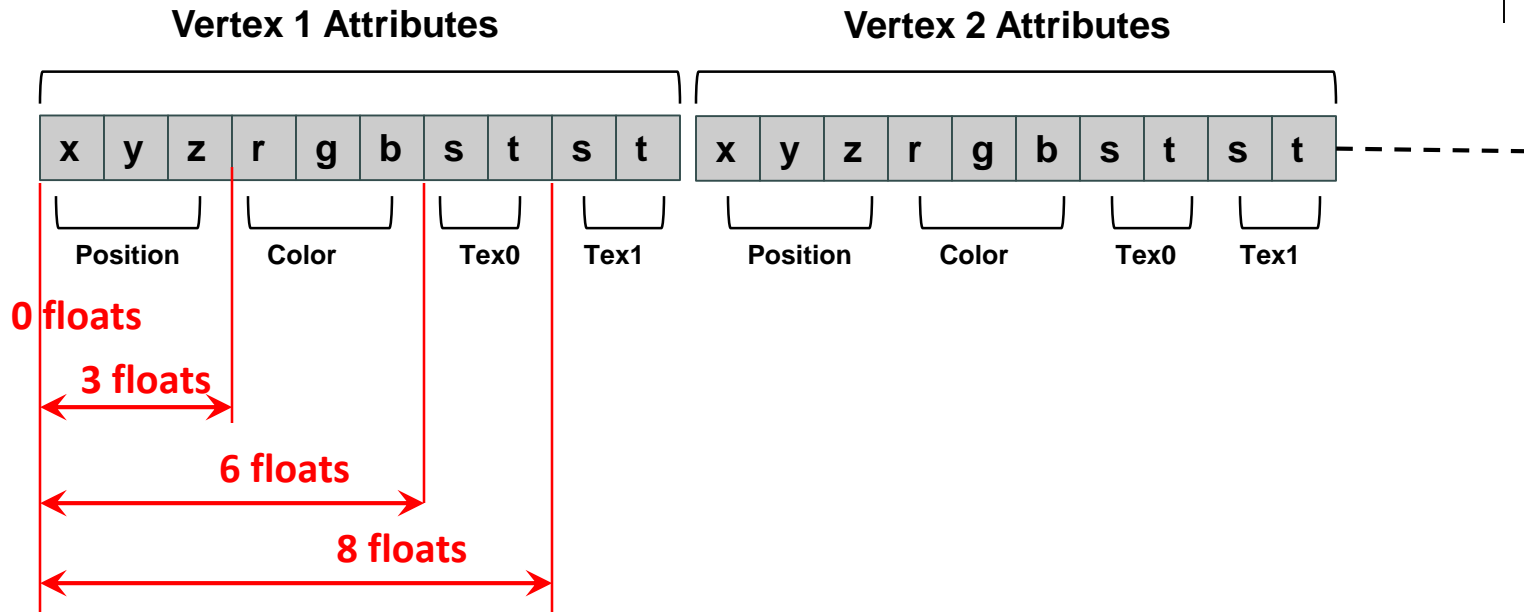

- Define offsets (# of floats) of each vertex attribute from beginning

```
#define VERTEX_POS_OFFSET          0
#define VERTEX_COLOR_OFFSET       3
#define VERTEX_TEXCOORD0_OFFSET   6
#define VERTEX_TEXCOORD1_OFFSET   8
```

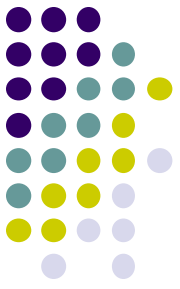

# Allocating Array of Vertex Attributes

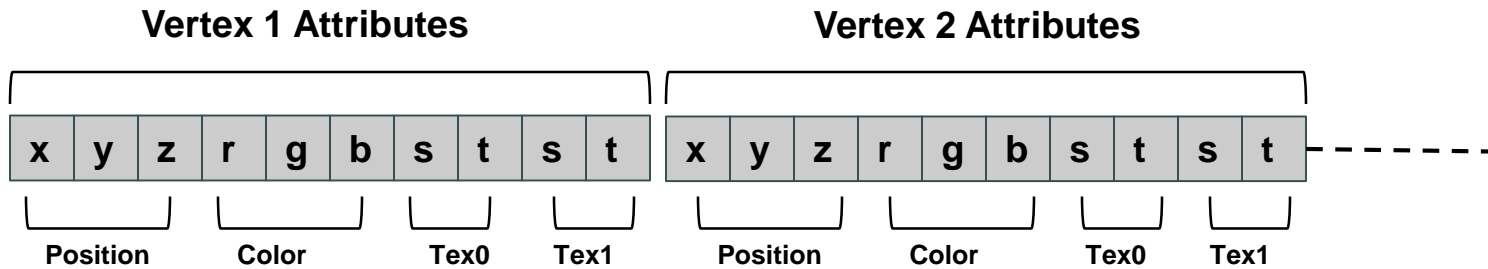

- Allocate memory for entire array of vertex attributes

Recall

```
#define VERTEX_ATTRIB_SIZE    VERTEX_POS_SIZE + VERTEX_COLOR_SIZE + \
                             VERTEX_TEXCOORD0_SIZE + \
                             VERTEX_TEXCOORD1_SIZE
```

```
float *p = malloc(numVertices * VERTEX_ATTRIB_SIZE * sizeof(float));
```

Allocate memory for all vertices





# Specifying Array of Vertex Attributes

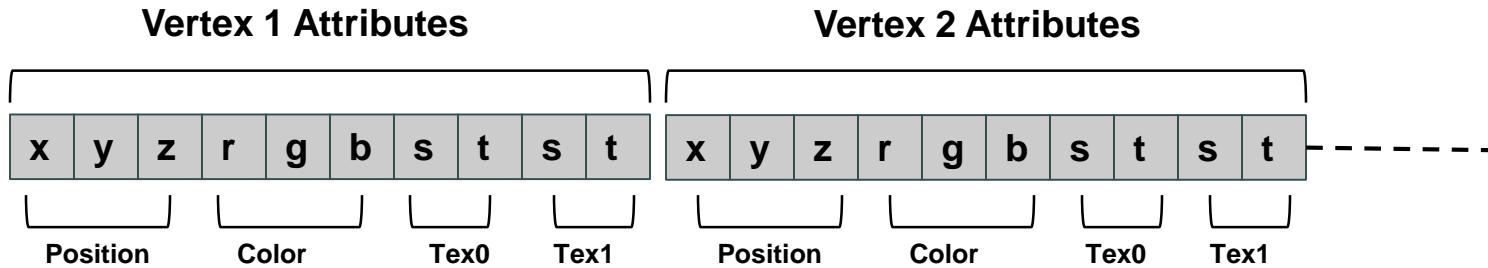

- **glVertexAttribPointer** used to specify vertex attributes
- Example: to specify vertex position attribute

```
glVertexAttribPointer(VERTEX_POS_INDx, VERTEX_POS_SIZE,  
GL_FLOAT, GL_FALSE,  
VERTEX_ATTRIB_SIZE * sizeof(float), p);  
glEnableVertexAttribArray(0);
```

**Position 0** (points to VERTEX\_POS\_INDx)

**3 values (x, y, z)** (points to VERTEX\_POS\_SIZE)

**Data is floats** (points to GL\_FLOAT)

**Data should not Be normalized** (points to GL\_FALSE)

**Stride: distance between consecutive vertices** (points to VERTEX\_ATTRIB\_SIZE \* sizeof(float))

**Pointer to data** (points to p)

- do same for normal, tex0 and tex1

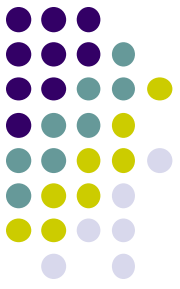

# Full Example: Rotating Cube in 3D

- **Desired Program behaviour:**
  - Draw colored cube
  - Continuous rotation about X,Y or Z axis
    - Idle function called repeatedly when nothing to do
    - Increment angle of rotation in idle function
  - Use 3-button mouse to change direction of rotation
    - Click left button -> rotate cube around X axis
    - Click middle button -> rotate cube around Y axis
    - Click right button -> rotate cube around Z axis
- Use default camera
  - If we don't set camera, we get a default camera
  - Located at origin and points in the negative z direction

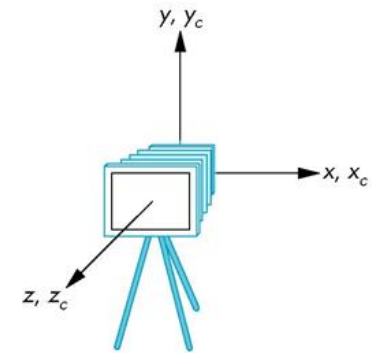
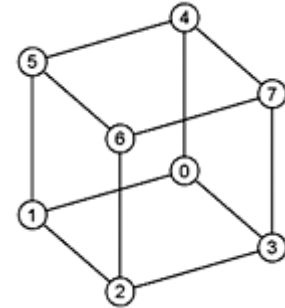

(a)

# Cube Vertices



Declare array of (x,y,z,w) vertex positions  
for a unit cube centered at origin  
(Sides aligned with axes)

```
point4 vertices[8] = {  
  0 point4( -0.5, -0.5,  0.5, 1.0 ),  
  1 point4( -0.5,  0.5,  0.5, 1.0 ),  
  2 point4(  0.5,  0.5,  0.5, 1.0 ),  
  3 point4(  0.5, -0.5,  0.5, 1.0 ),  
  4 point4( -0.5, -0.5, -0.5, 1.0 ),  
  5 point4( -0.5,  0.5, -0.5, 1.0 ),  
  6 point4(  0.5,  0.5, -0.5, 1.0 ),  
  7 point4(  0.5, -0.5, -0.5, 1.0 )  
};  
      x      y      z      w
```

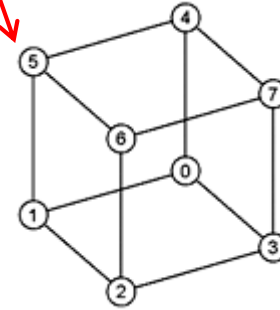

```
color4 vertex_colors[8] = {  
  color4( 0.0, 0.0, 0.0, 1.0 ), // black  
  color4( 1.0, 0.0, 0.0, 1.0 ), // red  
  color4( 1.0, 1.0, 0.0, 1.0 ), // yellow  
  color4( 0.0, 1.0, 0.0, 1.0 ), // green  
  color4( 0.0, 0.0, 1.0, 1.0 ), // blue  
  color4( 1.0, 0.0, 1.0, 1.0 ), // magenta  
  color4( 1.0, 1.0, 1.0, 1.0 ), // white  
  color4( 0.0, 1.0, 1.0, 1.0 ) // cyan  
};  
      r      g      b      w
```

Declare array of vertex colors  
(set of RGBA colors vertex can have)

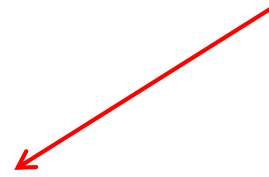

# Color Cube

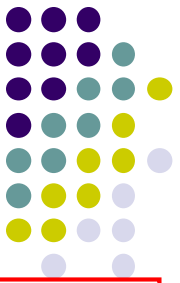

```
// generate 6 quads,  
// sides of cube  
  
void colorcube()  
{  
    quad( 1, 0, 3, 2 );  
    quad( 2, 3, 7, 6 );  
    quad( 3, 0, 4, 7 );  
    quad( 6, 5, 1, 2 );  
    quad( 4, 5, 6, 7 );  
    quad( 5, 4, 0, 1 );  
}
```

```
point4 vertices[8] = {  
    0 point4( -0.5, -0.5, 0.5, 1.0 ),  
    1 point4( -0.5, 0.5, 0.5, 1.0 ),  
    point4( 0.5, 0.5, 0.5, 1.0 ),  
    point4( 0.5, -0.5, 0.5, 1.0 ),  
    4 point4( -0.5, -0.5, -0.5, 1.0 ),  
    5 point4( -0.5, 0.5, -0.5, 1.0 ),  
    point4( 0.5, 0.5, -0.5, 1.0 ),  
    point4( 0.5, -0.5, -0.5, 1.0 )  
};
```

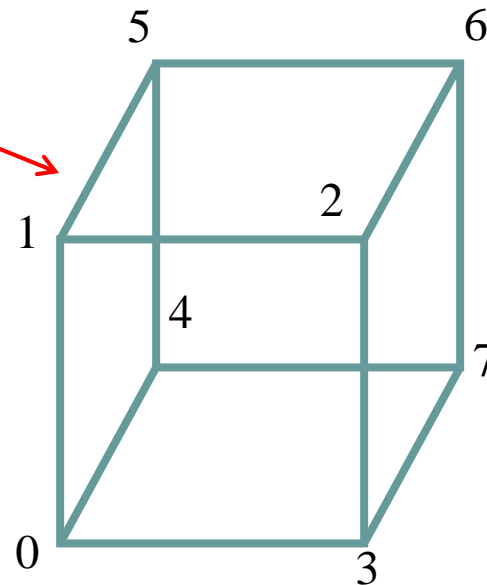

Function **quad** is  
Passed vertex indices



# Quad Function

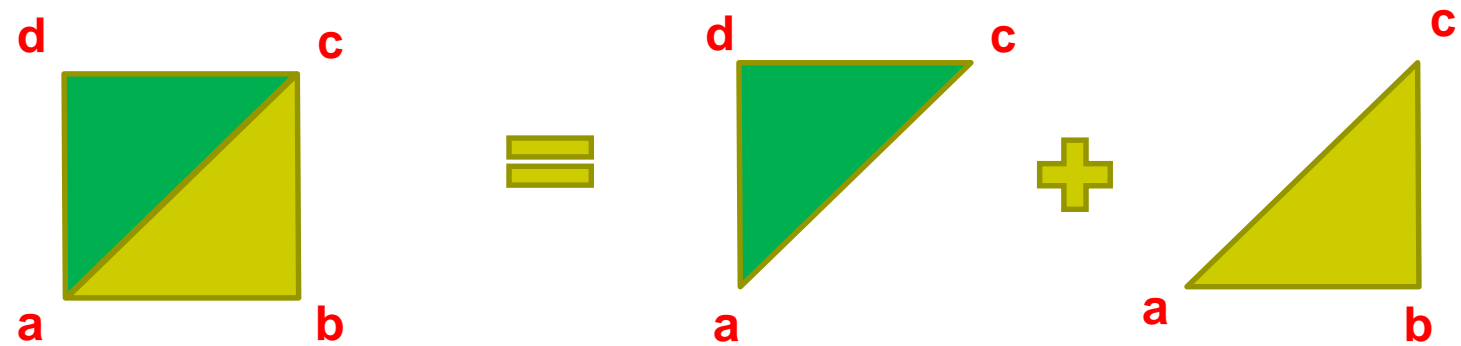

// quad generates two triangles (a,b,c) and (a,c,d) for each face  
// and assigns colors to the vertices

int Index = 0; // Index goes 0 to 5, one per vertex of face

```
void quad( int a, int b, int c, int d )  
{  
  0 colors[Index] = vertex_colors[a]; points[Index] = vertices[a]; Index++;  
  1 colors[Index] = vertex_colors[b]; points[Index] = vertices[b]; Index++;  
  2 colors[Index] = vertex_colors[c]; points[Index] = vertices[c]; Index++;  
  3 colors[Index] = vertex_colors[a]; points[Index] = vertices[a]; Index++;  
  4 colors[Index] = vertex_colors[c]; points[Index] = vertices[c]; Index++;  
  5 colors[Index] = vertex_colors[d]; points[Index] = vertices[d]; Index++;  
}
```

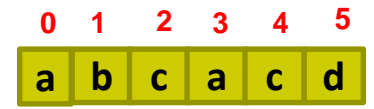

quad 0 = points[0 - 5]  
quad 1 = points[6 - 11]  
quad 2 = points [12 - 17] ...etc

Points[ ] array to be  
Sent to GPU

Read from appropriate index  
of unique positions declared

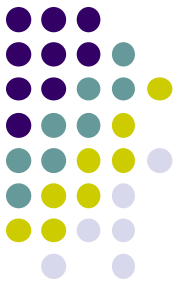

# Initialization I

```
void init()
{
    colorcube(); // Generates cube data in application using quads

    // Create a vertex array object
    GLuint vao;
    glGenVertexArrays ( 1, &vao );
    glBindVertexArray ( vao );

    // Create a buffer object and move data to GPU
    GLuint buffer;
    glGenBuffers( 1, &buffer );
    glBindBuffer( GL_ARRAY_BUFFER, buffer );
    glBufferData( GL_ARRAY_BUFFER, sizeof(points) +
                 sizeof(colors), NULL, GL_STATIC_DRAW );
}
```



Points[ ] array of vertex  
positions sent to GPU

colors[ ] array of vertex  
colors sent to GPU

# Initialization II



Send `points[ ]` and `colors[ ]` data to GPU separately using `glBufferSubData`

```
glBufferSubData( GL_ARRAY_BUFFER, 0, sizeof(points), points );  
glBufferSubData( GL_ARRAY_BUFFER, sizeof(points), sizeof(colors), colors );
```



```
// Load vertex and fragment shaders and use the resulting shader program  
GLuint program = InitShader( "vshader36.glsl", "fshader36.glsl" );  
glUseProgram( program );
```

# Initialization III



```
// set up vertex arrays
```

```
GLuint vPosition = glGetAttribLocation( program, "vPosition" );  
glEnableVertexAttribArray( vPosition );  
glVertexAttribPointer( vPosition, 4, GL_FLOAT, GL_FALSE, 0,   
                      BUFFER_OFFSET(0) );
```

Specify vertex data

```
GLuint vColor = glGetAttribLocation( program, "vColor" );  
glEnableVertexAttribArray( vColor );  
glVertexAttribPointer( vColor, 4, GL_FLOAT, GL_FALSE, 0,   
                      BUFFER_OFFSET(sizeof(points)) );
```

Specify color data



```
theta = glGetUniformLocation( program, "theta" );
```

Want to Connect rotation variable theta  
in program to variable in shader



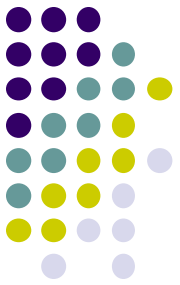

# Display Callback

```
void display( void )
{
    glClear( GL_COLOR_BUFFER_BIT|GL_DEPTH_BUFFER_BIT );

    glUniform3fv( theta, 1, theta );
    glDrawArrays( GL_TRIANGLES, 0, NumVertices );

    glutSwapBuffers();
}
```

Draw series of triangles forming cube

A red arrow originates from the text 'Draw series of triangles forming cube' and points upwards to the 'glDrawArrays' line in the code block above.

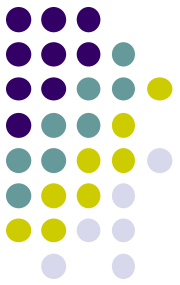

# Mouse Callback

```
...
enum { Xaxis = 0, Yaxis = 1, Zaxis = 2, NumAxes = 3 };

void mouse( int button, int state, int x, int y )
{
    if ( state == GLUT_DOWN ) {
        switch( button ) {
            case GLUT_LEFT_BUTTON:    axis = Xaxis;  break;
            case GLUT_MIDDLE_BUTTON:  axis = Yaxis;  break;
            case GLUT_RIGHT_BUTTON:   axis = Zaxis;  break;
        }
    }
}
```

Select axis (x,y,z) to rotate around  
Using mouse click





# Idle Callback

```
void idle( void )  
{  
    theta[axis] += 0.01;  
  
    if ( theta[axis] > 360.0 ) {  
        theta[axis] -= 360.0;  
    }  
  
    glutPostRedisplay();  
}
```

The idle( ) function is called whenever nothing to do

Use it to increment rotation angle in steps of  $\theta = 0.01$  around currently selected axis

```
void main( void ){  
    .....  
  
    glutIdleFunc( idle );  
    .....  
}
```

**Note:** still need to:

- Apply rotation by (theta) in shader



# References

- Angel and Shreiner, Interactive Computer Graphics, 6<sup>th</sup> edition, Chapter 3
- Hill and Kelley, Computer Graphics using OpenGL, 3<sup>rd</sup> edition