

Computer Graphics (CS 543)

Lecture 10a: Sphere Maps, Viewport Transformation & Hidden Surface Removal

Prof Emmanuel Agu

*Computer Science Dept.
Worcester Polytechnic Institute (WPI)*





Sphere Environment Map

- Cube can be replaced by a sphere (sphere map)

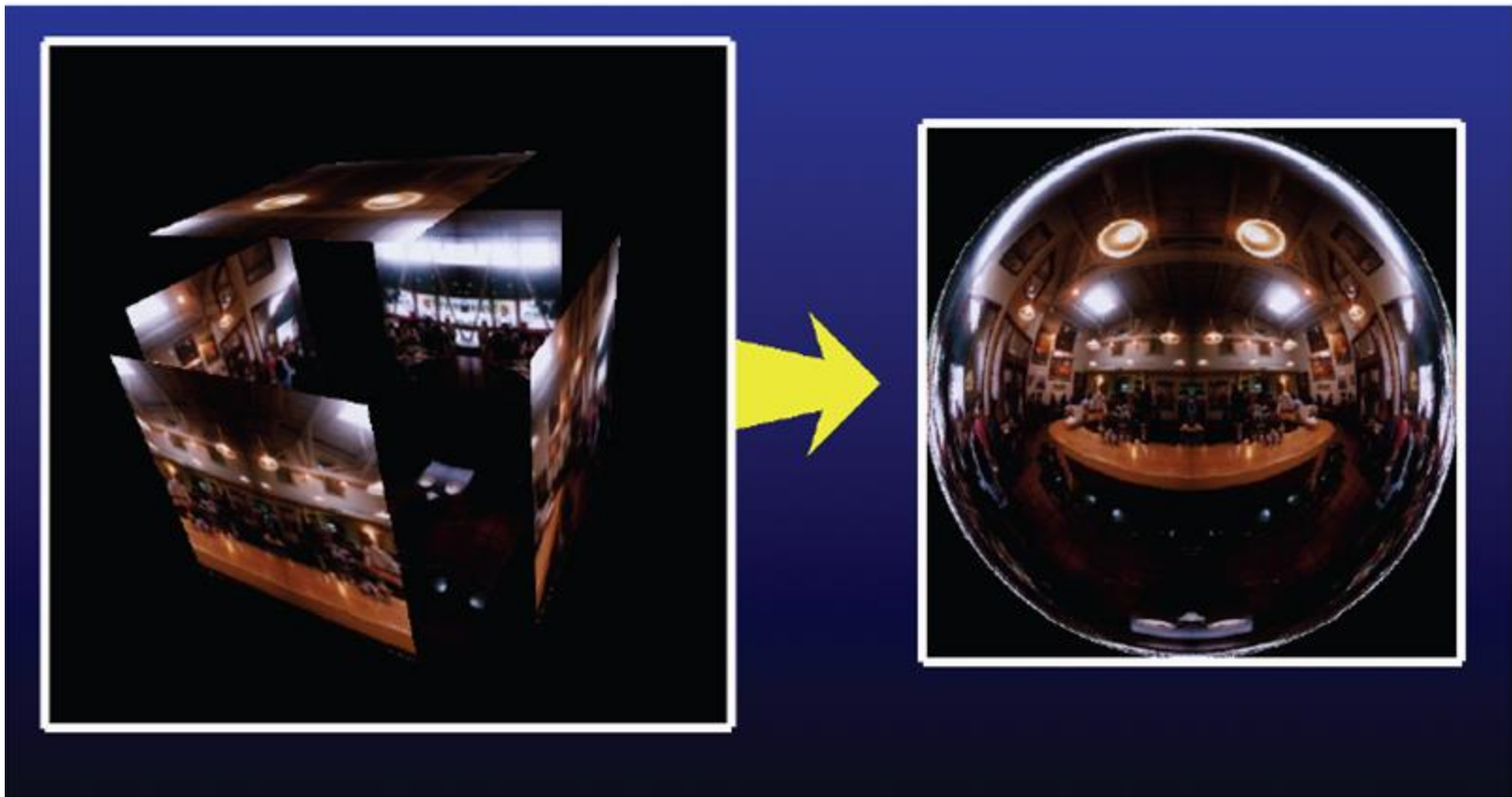



Sphere Mapping

- Original environmental mapping technique
- Proposed by Blinn and Newell
- Map longitude and latitude to texture coordinates
- OpenGL supports sphere mapping
- Requires a circular texture map equivalent to an image taken with a fisheye lens

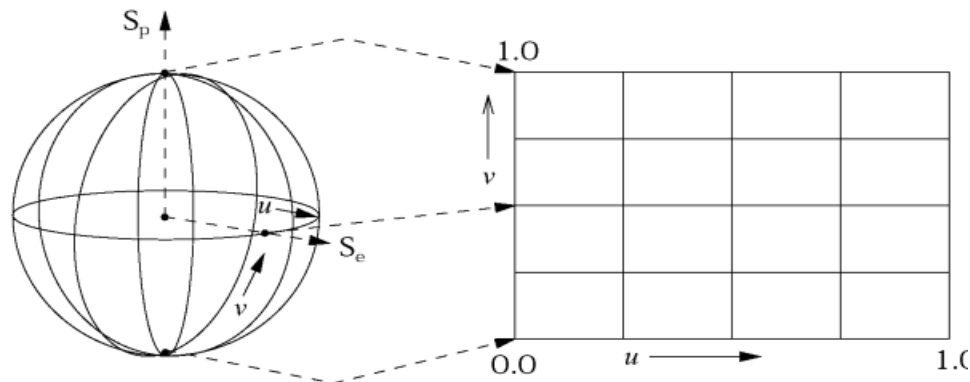



Sphere Map

- A sphere map is basically a photograph of a reflective sphere in an environment



Paul DeBevec, www.debevec.org



Sphere map

- example



Sphere map
(texture)



Sphere map
applied on torus

Capturing a Sphere Map



Matt Loper, MERL



Viewport Transformation



Viewport Transformation

- After projection, clipping, do viewport transformation
- Clipping eliminates lines outside view volume, truncates lines partially in-out
- More on clipping later

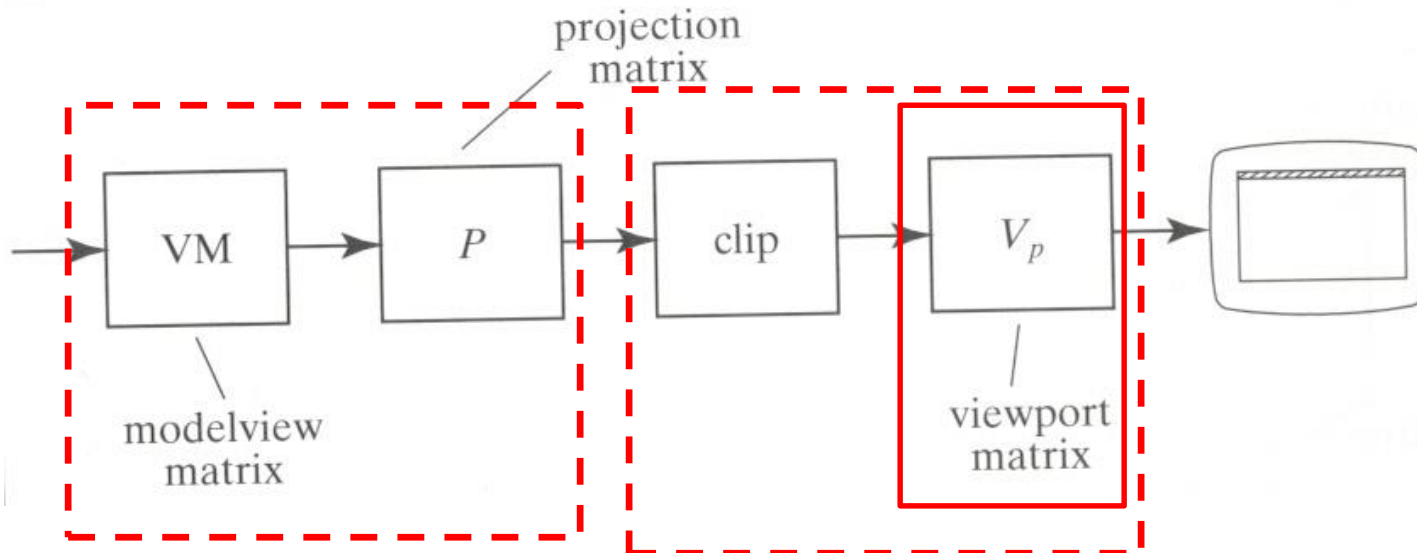

**User implements in
Vertex shader**

**Manufacturer
implements
In hardware**



Viewport Transformation

- Maps **CVV (x, y)** -> **screen (x, y)** coordinates

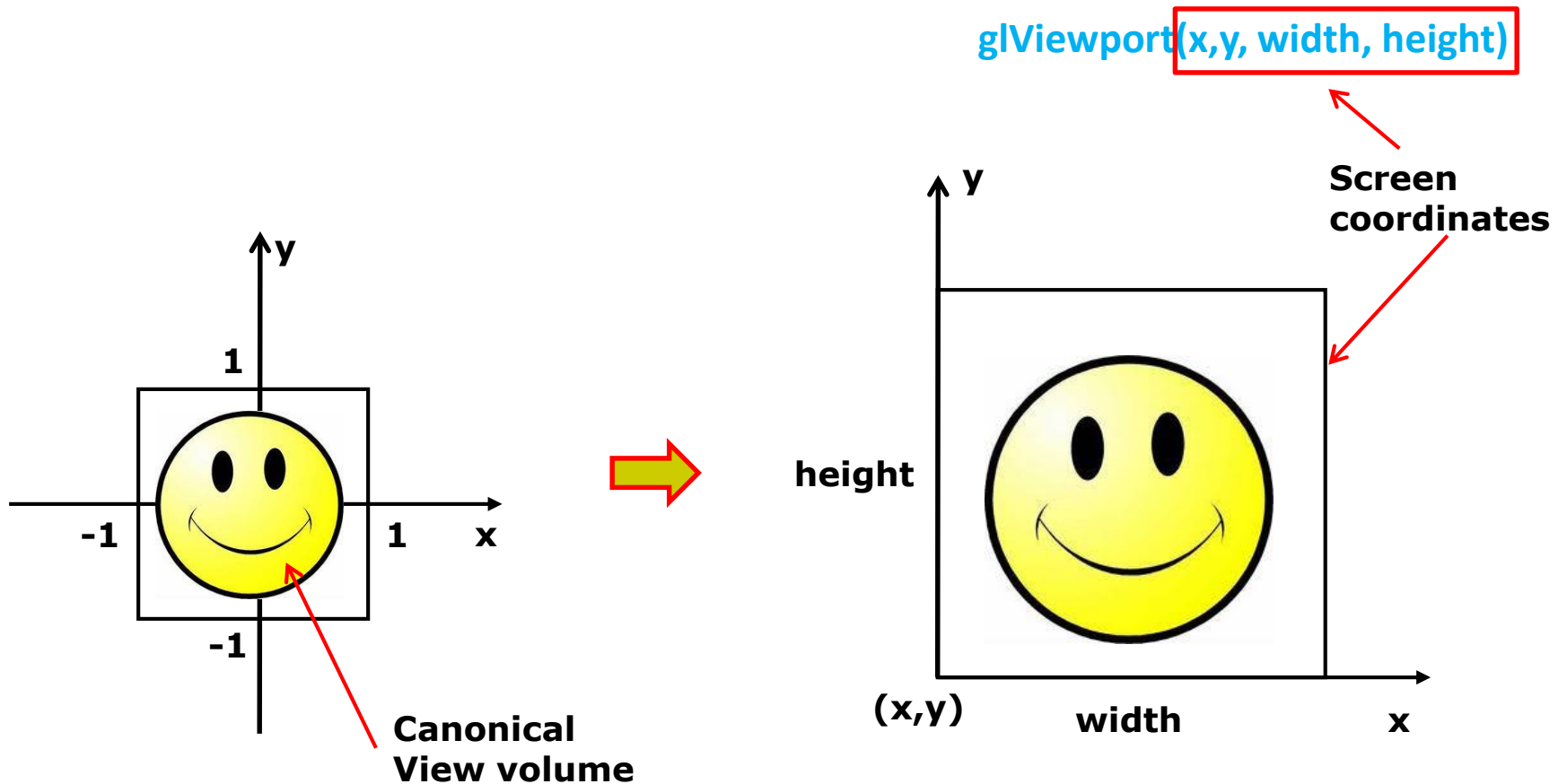



Viewport Transformation: What of z?

- Also maps z (pseudo-depth) from $[-1,1]$ to $[0,1]$
- $[0,1]$ pseudo-depth stored in depth buffer,
 - Used for Depth testing (Hidden Surface Removal)

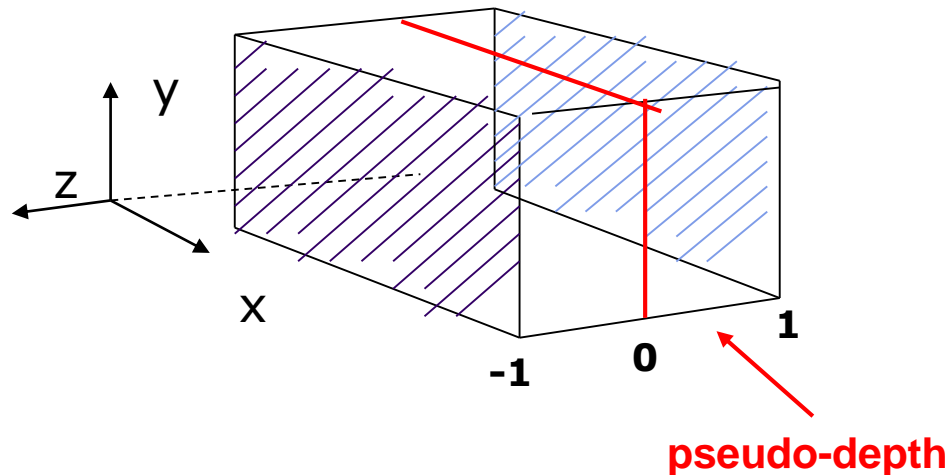



Hidden Surface Removal



Rasterization

- Rasterization Determines what pixels to color to draw a shape
 - Generates set of **fragments**
 - **Fragments:** Potential pixels, closest fragment becomes pixel
- Implemented by graphics hardware
- Rasterization algorithms for primitives (e.g lines, circles, triangles, polygons)

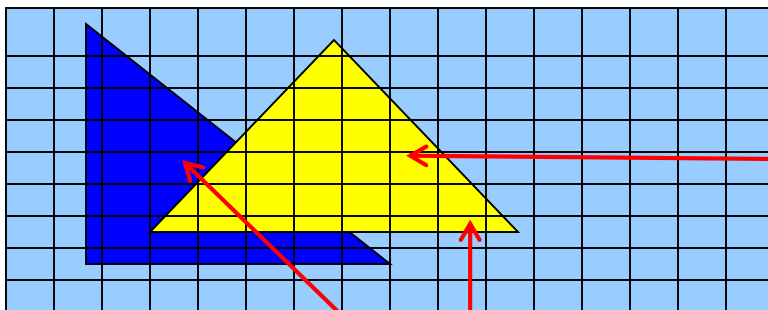

Fragments

**Rasterization: Determine Pixels
(fragments) each primitive covers**



Hidden surface Removal

- Drawing polygonal faces on screen consumes CPU cycles
- User cannot see every surface in scene
- To save time, draw only surfaces we see
- Methods to eliminate surfaces we cannot see?

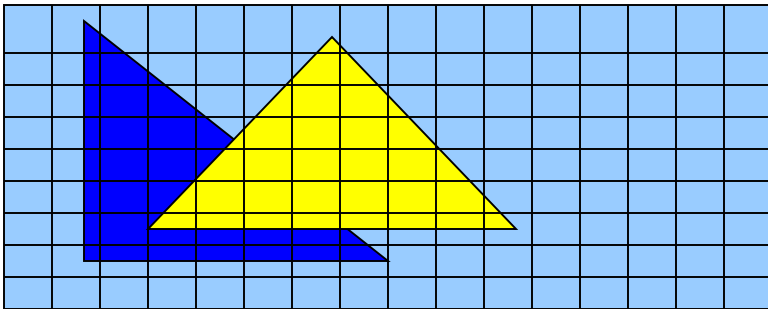

1. Occluded surfaces: hidden surface removal (visibility)

Back face

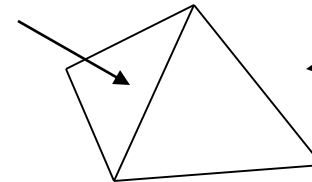

2. Back faces: back face culling

Hidden surface Removal



- Surfaces we cannot see and elimination methods:
 - **3. Faces outside view volume:** viewing frustum culling

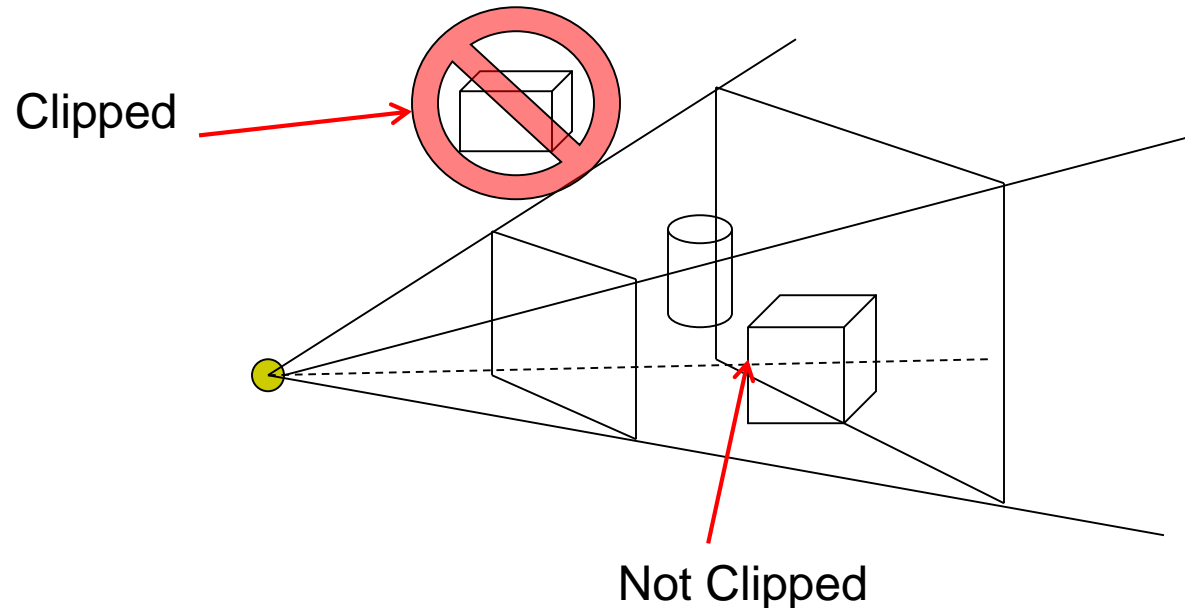

- Classes of HSR techniques:
 - **Object space techniques:** applied before rasterization
 - **Image space techniques:** applied after rasterization



Visibility (hidden surface removal)

- Overlapping opaque polygons
- **Correct visibility?** Draw only the closest polygon
 - (remove occluded/hidden surfaces)

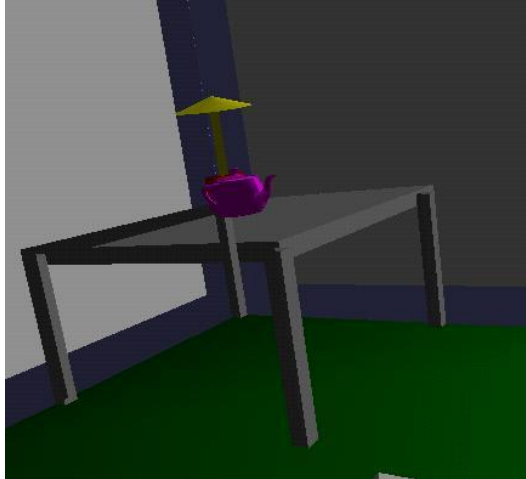

wrong visibility

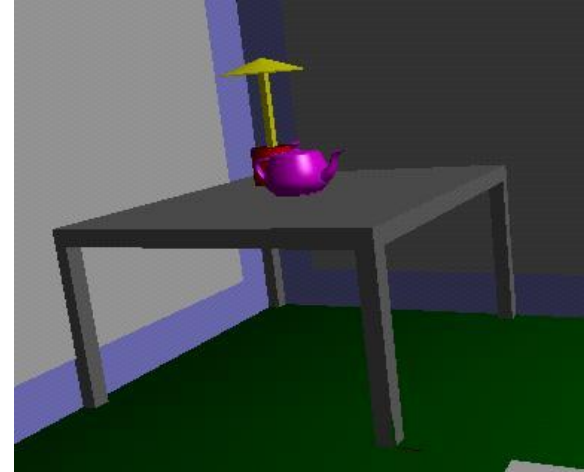

Correct visibility



Image Space Approach

- Start from pixel, work backwards into the scene
- Through each pixel, (nm for an $n \times m$ frame buffer) find closest of k polygons
- Complexity $O(nmk)$
- Examples:
 - Ray tracing
 - z-buffer : OpenGL

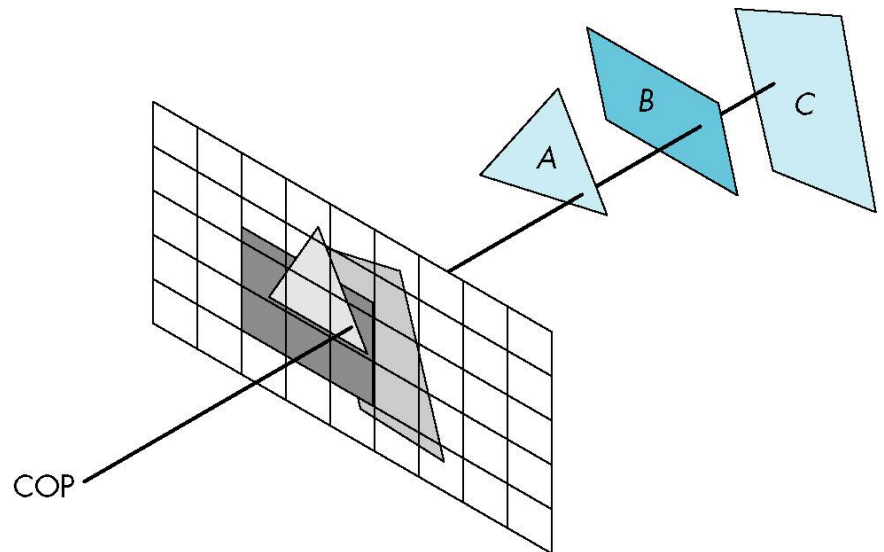



OpenGL - Image Space Approach

- Paint pixel with color of **closest** object

```
for (each pixel in image) {  
    determine the object closest to the pixel  
    draw the pixel using the object's color  
}
```

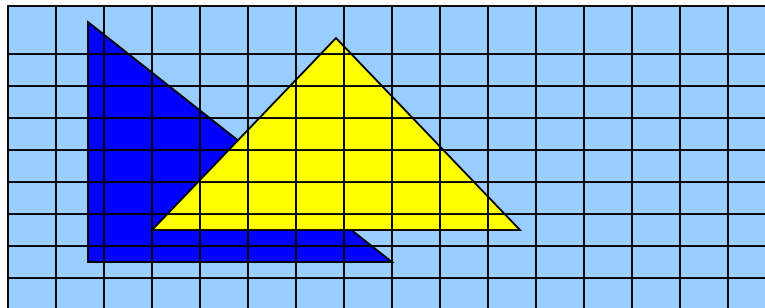

Z buffer Illustration

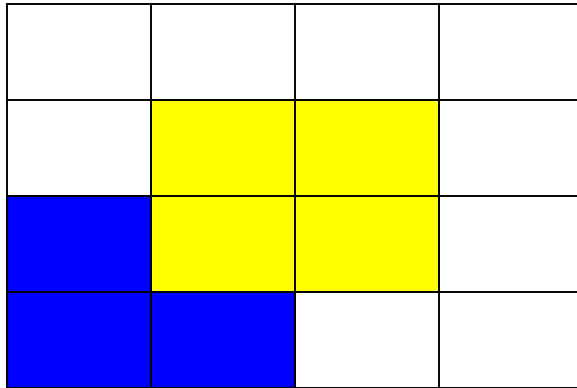

Correct Final image

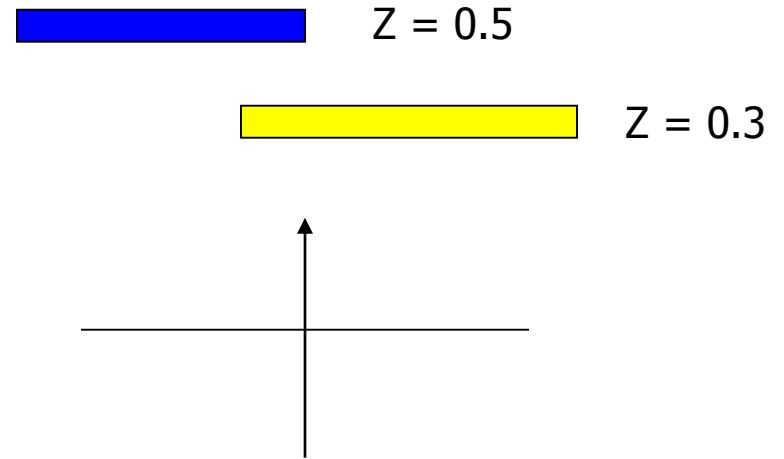

eye

Top View



Z buffer Illustration

Step 1: Initialize the depth buffer

1.0	1.0	1.0	1.0
1.0	1.0	1.0	1.0
1.0	1.0	1.0	1.0
1.0	1.0	1.0	1.0

Largest possible
z values is 1.0

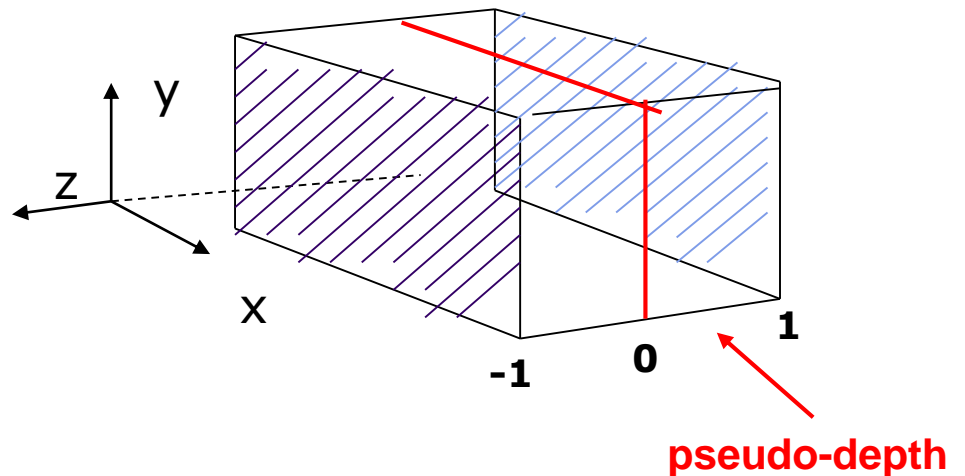



Z buffer Illustration

Step 2: Draw blue polygon
(actually order does not affect final result)

1.0	1.0	1.0	1.0
1.0	1.0	1.0	1.0
0.5	0.5	1.0	1.0
0.5	0.5	1.0	1.0

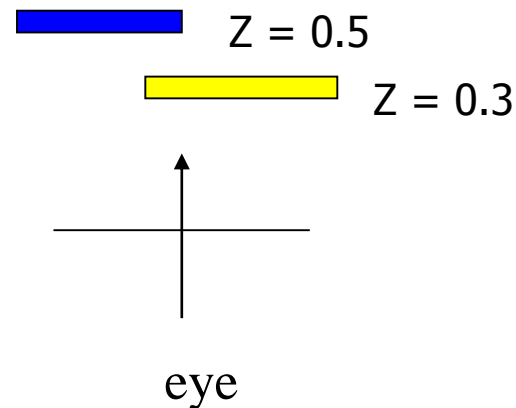

1. Determine group of pixels corresponding to blue polygon
2. Figure out z value of blue polygon for each covered pixel (0.5)
3. For each covered pixel, $z = 0.5$ is less than 1.0
 1. Smallest z so far = 0.5, color = blue



Z buffer Illustration

Step 3: Draw the yellow polygon

1.0	1.0	1.0	1.0
1.0	0.3	0.3	1.0
0.5	0.3	0.3	1.0
0.5	0.5	1.0	1.0

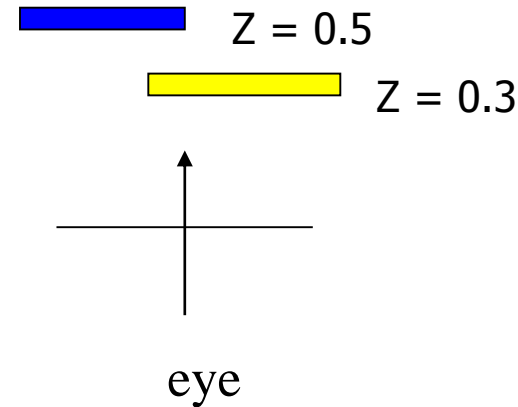

1. Determine group of pixels corresponding to yellow polygon
2. Figure out z value of yellow polygon for each covered pixel (0.3)
3. For each covered pixel, $z = 0.3$ becomes minimum, color = yellow

z-buffer drawback: wastes resources drawing and redrawing faces



OpenGL HSR Commands

- 3 main commands to do HSR
- `glutInitDisplayMode (GLUT_DEPTH | GLUT_RGB)` creates depth buffer
- `glEnable (GL_DEPTH_TEST)` enables depth testing
- `glClear (GL_COLOR_BUFFER_BIT | GL_DEPTH_BUFFER_BIT)` initializes depth buffer every time we draw a new picture

1.0	1.0	1.0	1.0
1.0	1.0	1.0	1.0
1.0	1.0	1.0	1.0
1.0	1.0	1.0	1.0



Z-buffer Algorithm

- Initialize every pixel's z value to 1.0
- rasterize every polygon
- For each pixel in polygon, find its z value (interpolate)
- Track smallest z value so far at each pixel
- As we rasterize polygon, for each pixel in polygon
 - If polygon's z at this pixel $<$ current min z through pixel
 - Paint pixel with polygon's color

Find depth (z) of every polygon at each pixel

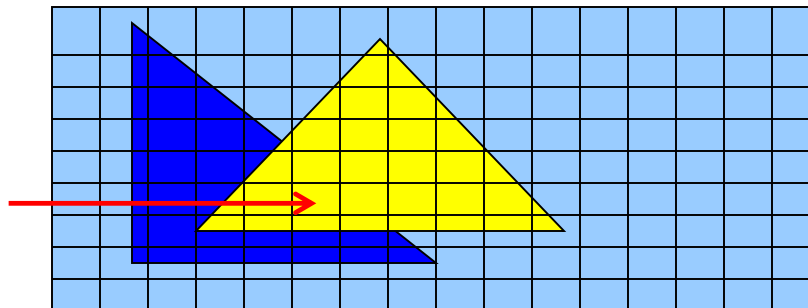



Z (depth) Buffer Algorithm

Depth of polygon being rasterized at pixel (x, y)

Smallest depth seen so far Through pixel (x, y)

```
For each polygon {  
  for each pixel (x,y) in polygon area {  
    if (z_polygon_pixel(x,y) < depth_buffer(x,y) ) {  
      depth_buffer(x,y) = z_polygon_pixel(x,y);  
      color_buffer(x,y) = polygon color at (x,y)  
    }  
  }  
}
```

Note: know depths at vertices. Interpolate for interior z_polygon_pixel(x, y) depths



Combined z-buffer and Gouraud Shading

(Hill Book, 2nd edition, pg 438)

- Can combine shading and HSR through scan line algorithm

```
for(int y = ybott; y <= ytop; y++) // for each scan line
{
    for(each polygon){
        find xleft and xright
        find dleft, dright, and dinc
        find colorleft, colorright, and colorinc
        for(int x = xleft, c = colorleft, d = dleft; x <= xright;
            x++, c+= colorinc, d+= dinc)
            if(d < d[x][y])
            {
                put c into the pixel at (x, y)
                d[x][y] = d; // update closest depth
            }
    }
}
```

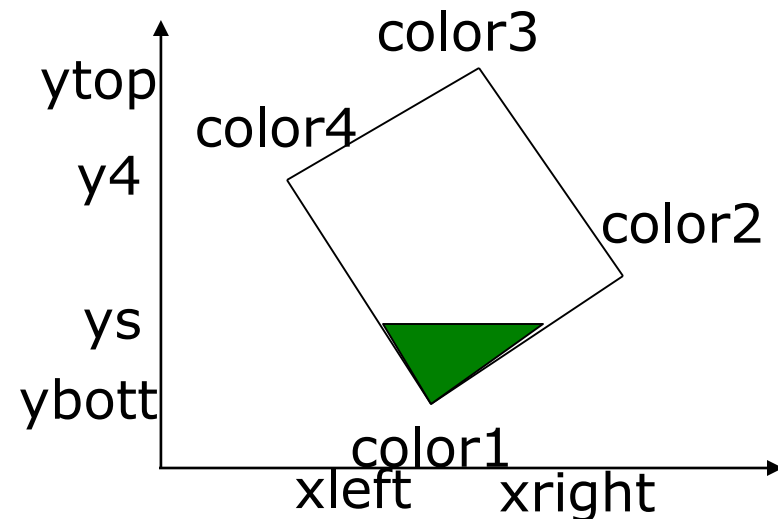
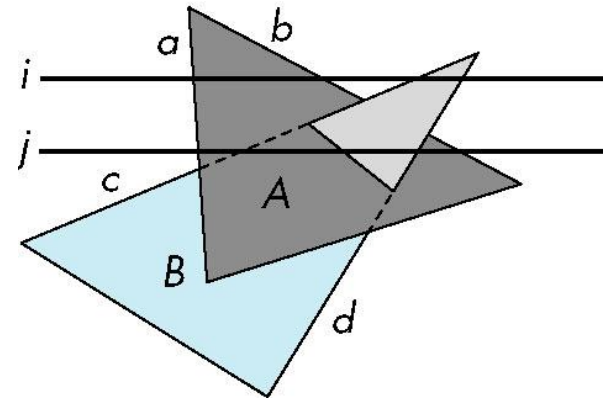

Perspective Transformation: Z-Buffer Depth Compression



- **Pseudodepth calculation:** Recall we chose parameters (a and b) to map z from range [near, far] to **pseudodepth** range[-1,1]

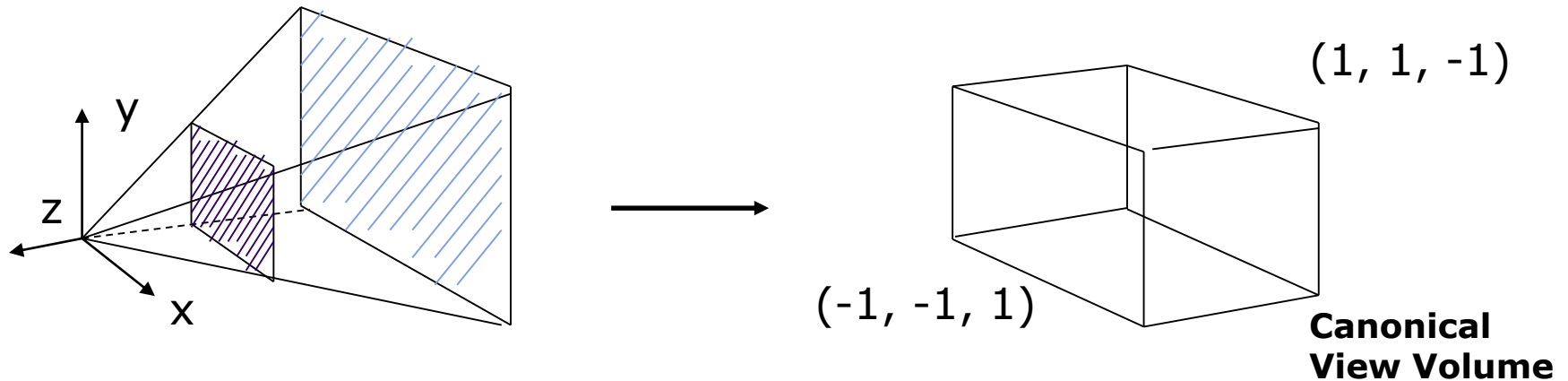

$$\begin{pmatrix} \frac{2N}{x_{\max} - x_{\min}} & 0 & \frac{\text{right} + \text{left}}{\text{right} - \text{left}} & 0 \\ 0 & \frac{2N}{\text{top} - \text{bottom}} & \frac{\text{top} + \text{bottom}}{\text{top} - \text{bottom}} & 0 \\ 0 & 0 & \boxed{\frac{-(F + N)}{F - N}} & \boxed{\frac{-2FN}{F - N}} \\ 0 & 0 & -1 & 0 \end{pmatrix} \begin{pmatrix} x \\ y \\ z \\ 1 \end{pmatrix}$$

a b

These values map z values of original view volume to [-1, 1] range



Z-Buffer Depth Compression

- This mapping is almost linear close to eye
- Non-linear further from eye, approaches asymptote
- Also limited number of bits
- Thus, two z values close to far plane may map to same pseudodepth: **Errors!!**

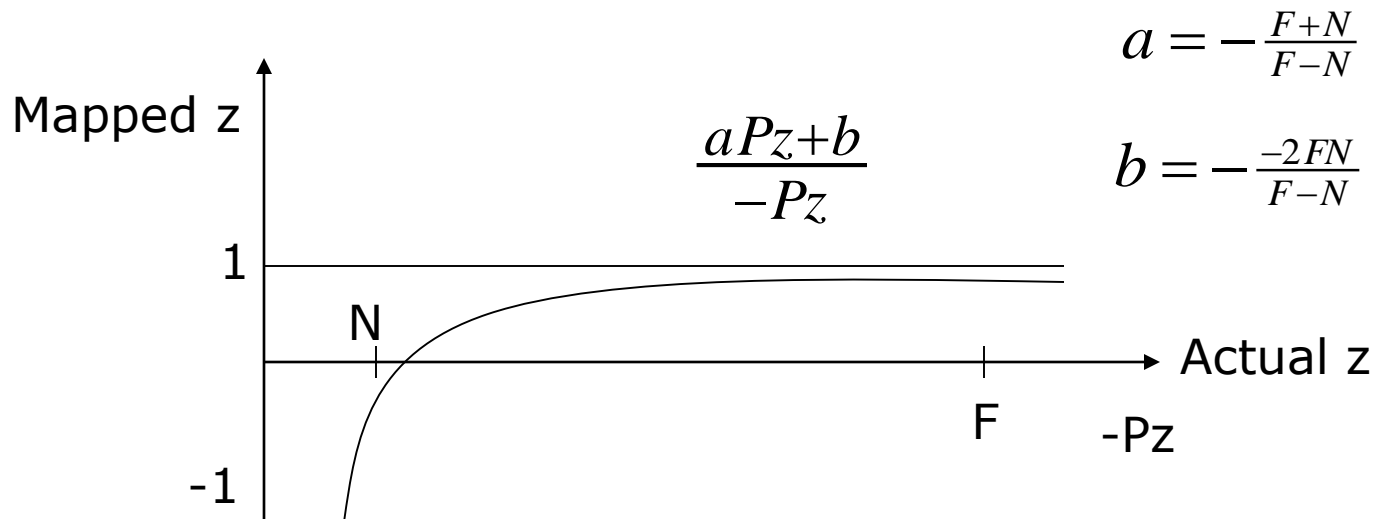



Painter's HSR Algorithm

- Render polygons farthest to nearest
- Similar to painter layers oil paint

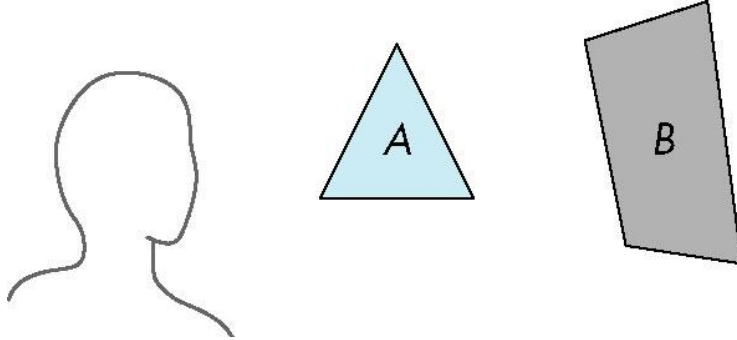

Viewer sees B behind A

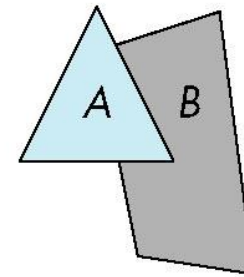

Render B then A



Depth Sort

- Requires sorting polygons (based on depth)
 - $O(n \log n)$ complexity to sort n polygon depths
 - Not every polygon is clearly in front or behind other polygons

Polygons sorted by distance from COP

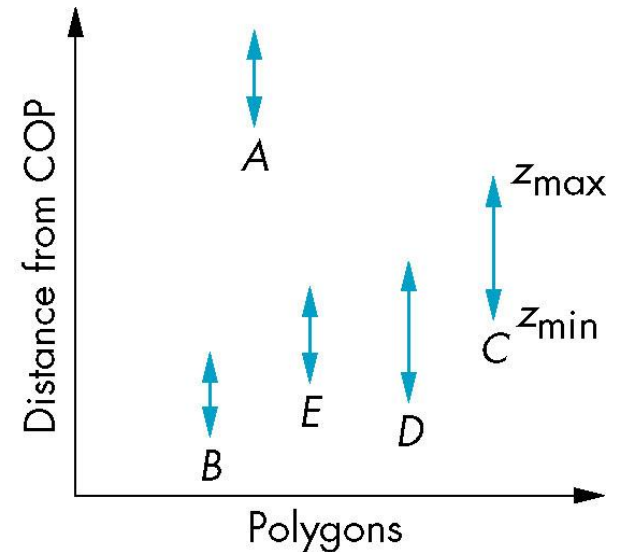

Easy Cases

- Case a: A lies behind all polygons

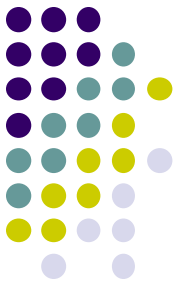
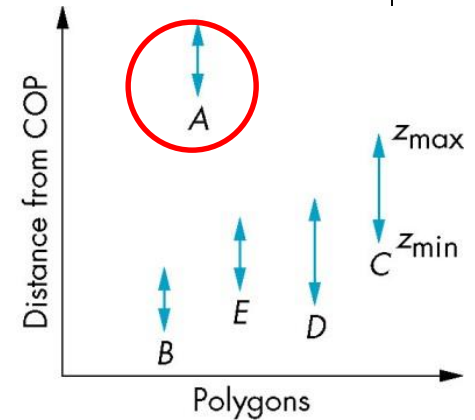

- Case b: Polygons overlap in z but **not** in x or y

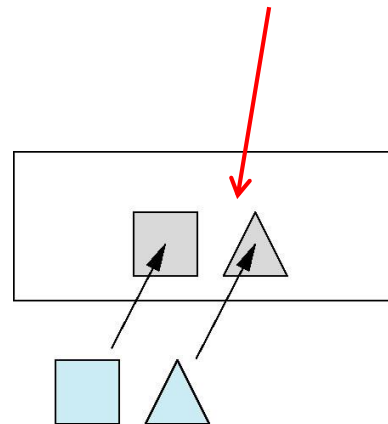

Hard Cases

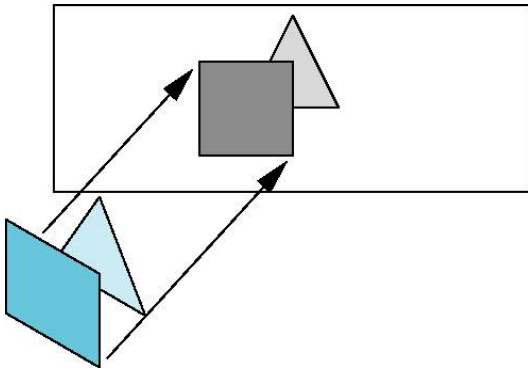

Overlap in (x,y) and z ranges

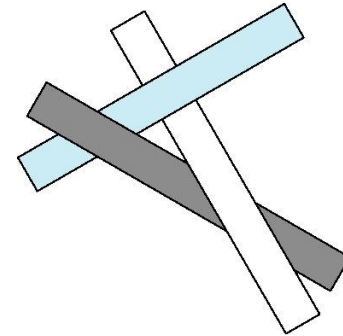

cyclic overlap

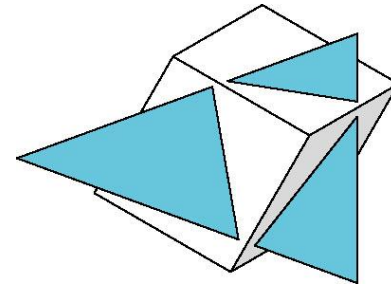

penetration



Back Face Culling

- **Back faces:** faces of opaque object that are “pointing away” from viewer
- **Back face culling:** do not draw back faces (saves resources)

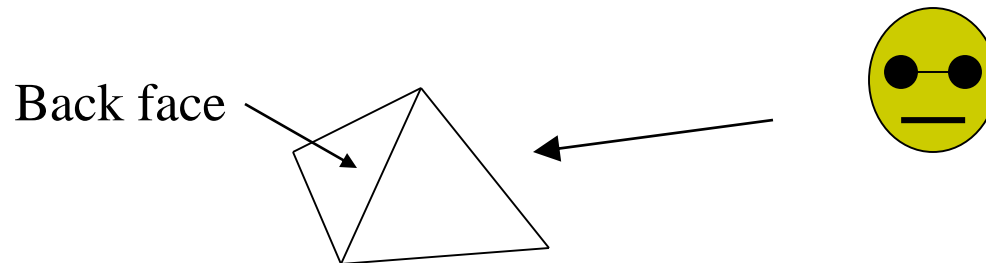

- How to detect back faces?



Back Face Culling

- Goal: Test if a face F is is backface
- How? Form vectors
 - View vector, V
 - Normal N to face F

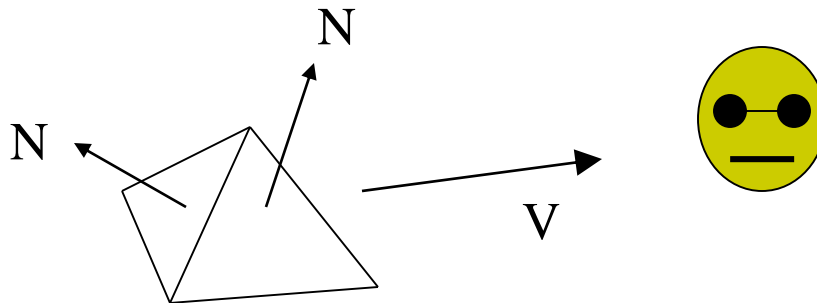

Backface test: F is backface if $N \cdot V < 0$ why??



Back Face Culling: Draw mesh front faces

```
void drawFrontFaces( )
{
    for(int f = 0;f < numFaces; f++)
    {
        if(isBackFace(f, ....) continue; ← if N.V < 0
        glDrawArrays(GL_POLYGON, 0, N);
    }
}
```



View-Frustum Culling

- **Goal:** Remove objects outside view frustum
- Done by 3D clipping algorithm (e.g. Liang-Barsky)

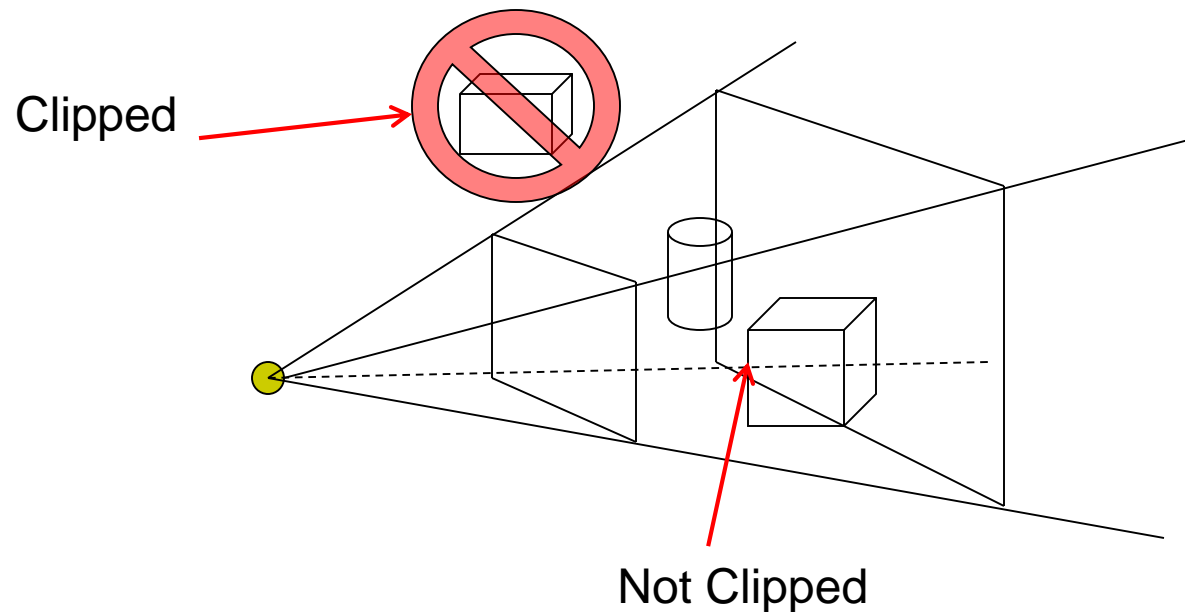



Ray Tracing

- Ray tracing is another image space method
- Ray tracing: Cast a ray from eye through each pixel into world.
- Ray tracing algorithm figures out: what object seen in direction through a certain pixel?

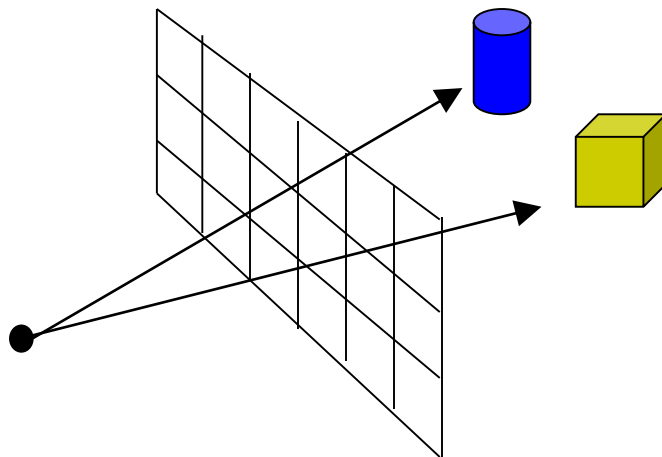

Overview later



References

- Angel and Shreiner, Interactive Computer Graphics, 6th edition
- Hill and Kelley, Computer Graphics using OpenGL, 3rd edition, Chapter 9