

Computer Graphics (CS 543)

Lecture 4a: Introduction to Transformations

Prof Emmanuel Agu

*Computer Science Dept.
Worcester Polytechnic Institute (WPI)*





Hidden-Surface Removal

- If multiple surfaces overlap, we want to see only **closest**
- OpenGL uses *hidden-surface* technique called the ***z-buffer*** algorithm
- Z-buffer compares objects distances from viewer (depth) to determine closer objects

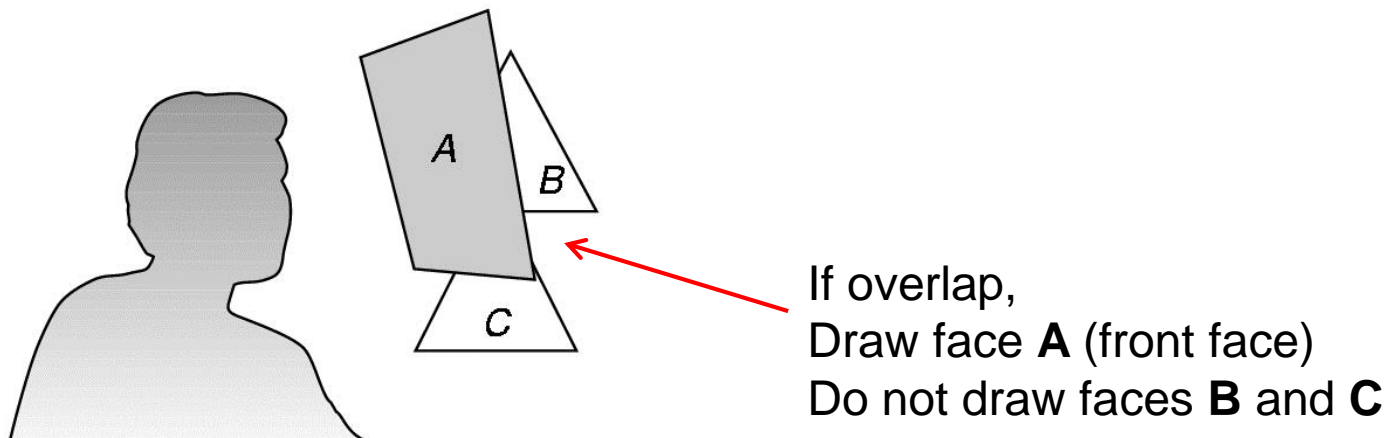



Using OpenGL's z-buffer algorithm

- Z-buffer uses an extra buffer, (the z-buffer), to store depth information, compare distance from viewer
- 3 steps to set up Z-buffer:

1. In **main()** function

```
glutInitDisplayMode(GLUT_SINGLE | GLUT_RGB | GLUT_DEPTH)
```

2. Enabled in **init()** function

```
glEnable(GL_DEPTH_TEST)
```

3. Clear depth buffer whenever we clear screen

```
glClear(GL_COLOR_BUFFER_BIT | DEPTH_BUFFER_BIT)
```



3D Mesh file formats

- 3D meshes usually stored in 3D file format
- Format defines how vertices, edges, and faces are declared
- Over 400 different file formats
- **Polygon File Format (PLY)** used a lot in graphics
- Originally PLY was used to store 3D files from 3D scanner
- We will use PLY files in this class

Sample PLY File

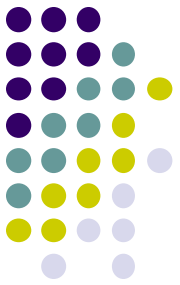









```
ply
format ascii 1.0
comment this is a simple file
obj_info any data, in one line of free form text element vertex 3
property float x
property float y
property float z
element face 1
property list uchar int vertex_indices
end_header
-1 0 0
0 1 0
1 0 0
3 0 1 2
```

Georgia Tech Large Models Archive

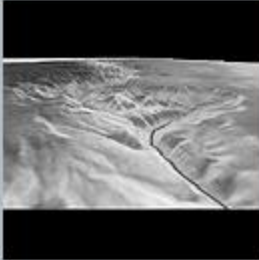
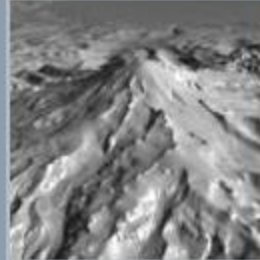

 *Models*

			
Stanford Bunny	Turbine Blade	Skeleton Hand	Dragon
			
Happy Buddha	Horse	Visible Man Skin	Visible Man Bone
			
Grand Canyon	Puget Sound	Angel	

Stanford 3D Scanning Repository

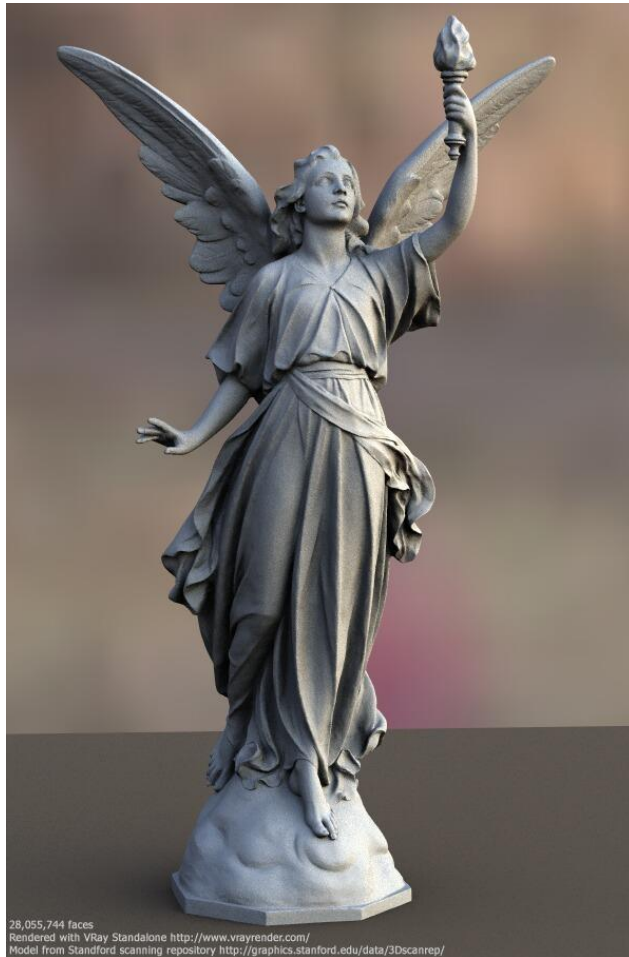

Lucy: 28 million faces



Happy Buddha: 9 million faces

Introduction to Transformations



- May also want to transform objects by changing its:
 - Position (translation)
 - Size (scaling)
 - Orientation (rotation)
 - Shapes (shear)

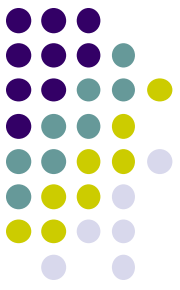

Translation

- Move each vertex by **same** distance $\mathbf{d} = (d_x, d_y, d_z)$

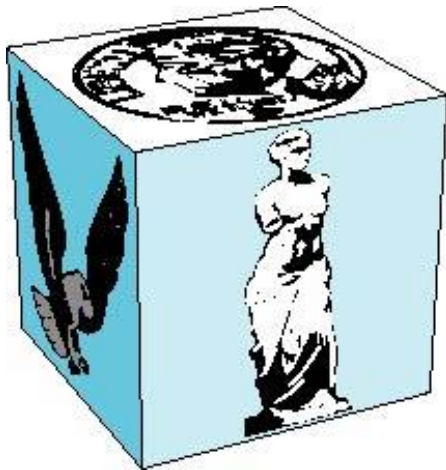

object

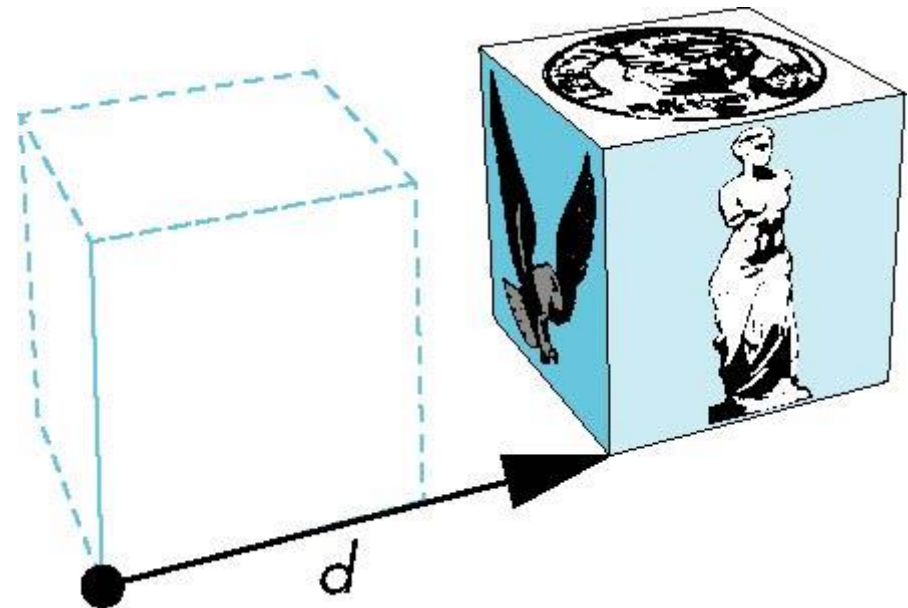

translation: every point displaced
by same vector

Scaling

Expand or contract along each axis (fixed point of origin)

$$x' = s_x x$$

$$y' = s_y y$$

$$z' = s_z z$$

$$\mathbf{p}' = \mathbf{S}\mathbf{p}$$

where

$$\mathbf{S} = \mathbf{S}(s_x, s_y, s_z)$$

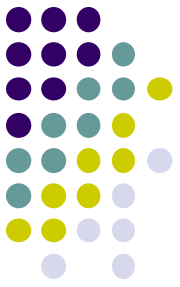
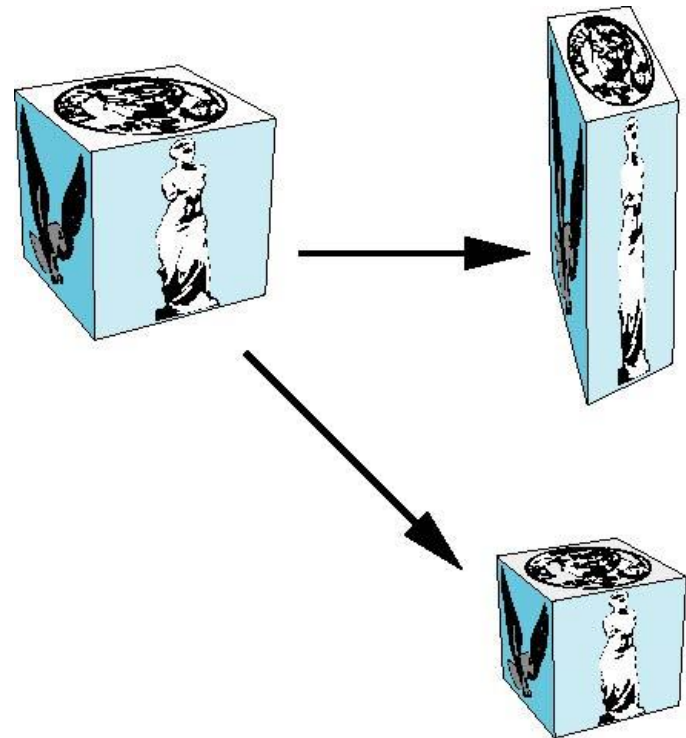



Introduction to Transformations

- We can transform (translation, scaling, rotation, shearing, etc) object by applying matrix multiplications to object vertices

$$\begin{array}{ccc} \begin{array}{c} \text{Transformed Vertex} \\ \nearrow \end{array} & \begin{array}{c} \begin{pmatrix} P'_x \\ P'_y \\ P'_z \\ 1 \end{pmatrix} = \begin{pmatrix} m_{11} & m_{12} & m_{13} & m_{14} \\ m_{21} & m_{22} & m_{23} & m_{24} \\ m_{31} & m_{32} & m_{33} & m_{34} \\ 0 & 0 & 0 & 1 \end{pmatrix} \begin{pmatrix} P_x \\ P_y \\ P_z \\ 1 \end{pmatrix} \\ \text{Transform Matrix} \end{array} & \begin{array}{c} \nwarrow \\ \text{Original Vertex} \end{array} \end{array}$$

- Note: point (x,y,z) needs to be represented as (x,y,z,1), also called **Homogeneous coordinates**



Why Matrices?

- Multiple transform matrices can be pre-multiplied
- One final resulting matrix applied (efficient!)
- For example:

transform 1 x transform 2 x transform 3

$$\begin{pmatrix} Q_x \\ Q_y \\ Q_z \\ 1 \end{pmatrix} = \begin{pmatrix} m_{11} & m_{12} & m_{13} & m_{14} \\ m_{21} & m_{22} & m_{23} & m_{24} \\ m_{31} & m_{32} & m_{33} & m_{34} \\ 0 & 0 & 0 & 1 \end{pmatrix} \begin{pmatrix} m_{11} & m_{12} & m_{13} & m_{14} \\ m_{21} & m_{22} & m_{23} & m_{24} \\ m_{31} & m_{32} & m_{33} & m_{34} \\ 0 & 0 & 0 & 1 \end{pmatrix} \begin{pmatrix} P_x \\ P_y \\ P_z \\ 1 \end{pmatrix}$$

Transformed Point

Transform Matrices can Be pre-multiplied

Original Point

3D Translation Example

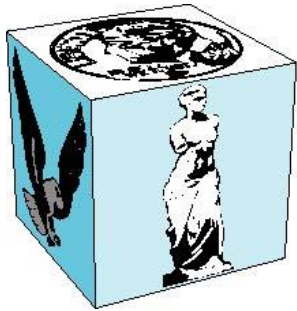

object

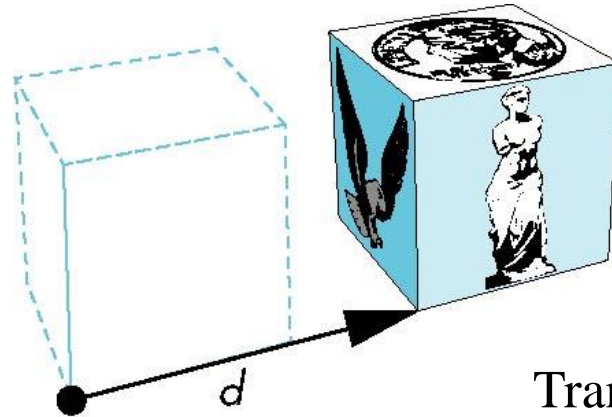

Translation of object

- **Example:** If we translate a point $(2,2,2)$ by displacement $(2,4,6)$, new location of point is $(4,6,8)$

Using matrix multiplication for translation

Translate(2,4,6)

- Translate x: $2 + 2 = 4$
- Translate y: $2 + 4 = 6$
- Translate z: $2 + 6 = 8$

$$\begin{pmatrix} 4 \\ 6 \\ 8 \\ 1 \end{pmatrix} = \begin{pmatrix} 1 & 0 & 0 & 2 \\ 0 & 1 & 0 & 4 \\ 0 & 0 & 1 & 6 \\ 0 & 0 & 0 & 1 \end{pmatrix} \times \begin{pmatrix} 2 \\ 2 \\ 2 \\ 1 \end{pmatrix}$$

Translated point Translation Matrix Original point

3D Translation

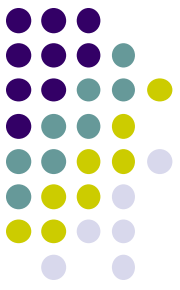

- Translate object = Move each vertex by same distance $\mathbf{d} = (d_x, d_y, d_z)$

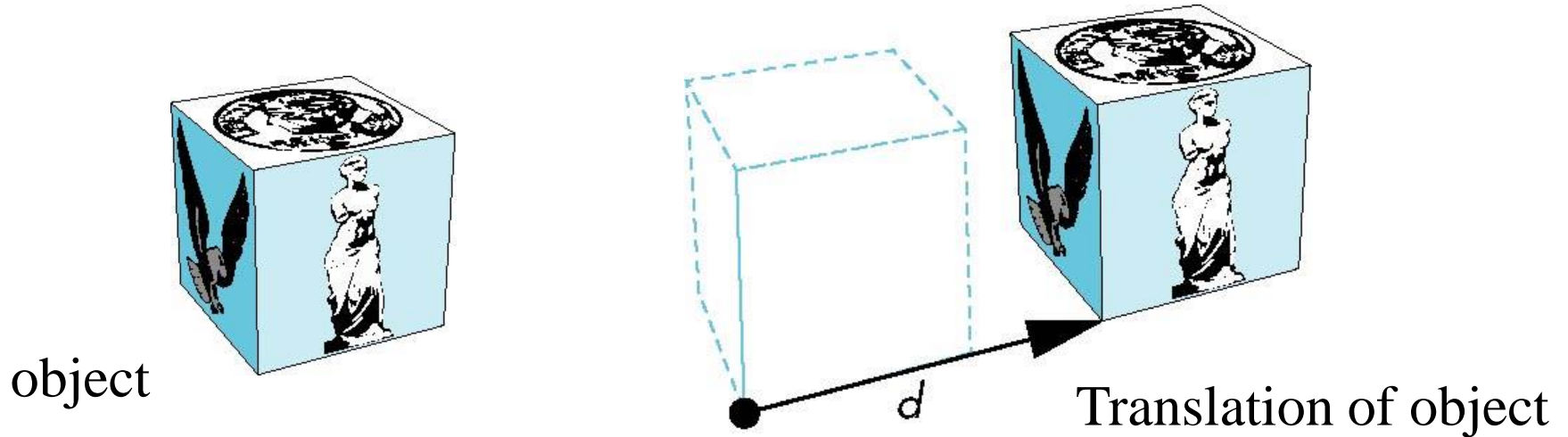

Translate(dx,dy,dz)

■Where:

- $x' = x + dx$
- $y' = y + dy$
- $z' = z + dz$

$$\begin{pmatrix} x' \\ y' \\ z' \\ 1 \end{pmatrix} = \begin{pmatrix} 1 & 0 & 0 & d_x \\ 0 & 1 & 0 & d_y \\ 0 & 0 & 1 & d_z \\ 0 & 0 & 0 & 1 \end{pmatrix} * \begin{pmatrix} x \\ y \\ z \\ 1 \end{pmatrix}$$

Translation Matrix

Scaling Example

If we scale a point (2,4,6) by scaling factor (0.5,0.5,0.5)

Scaled point position = (1, 2, 3)

- Scale x: $2 \times 0.5 = 1$
- Scale y: $4 \times 0.5 = 2$
- Scale z: $6 \times 0.5 = 3$

$$\begin{pmatrix} 1 \\ 2 \\ 3 \\ 1 \end{pmatrix} = \begin{pmatrix} 0.5 & 0 & 0 & 0 \\ 0 & 0.5 & 0 & 0 \\ 0 & 0 & 0.5 & 0 \\ 0 & 0 & 0 & 1 \end{pmatrix} \times \begin{pmatrix} 2 \\ 4 \\ 6 \\ 1 \end{pmatrix}$$

**Scale Matrix for
Scale(0.5, 0.5, 0.5)**

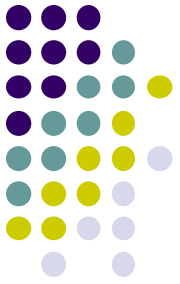
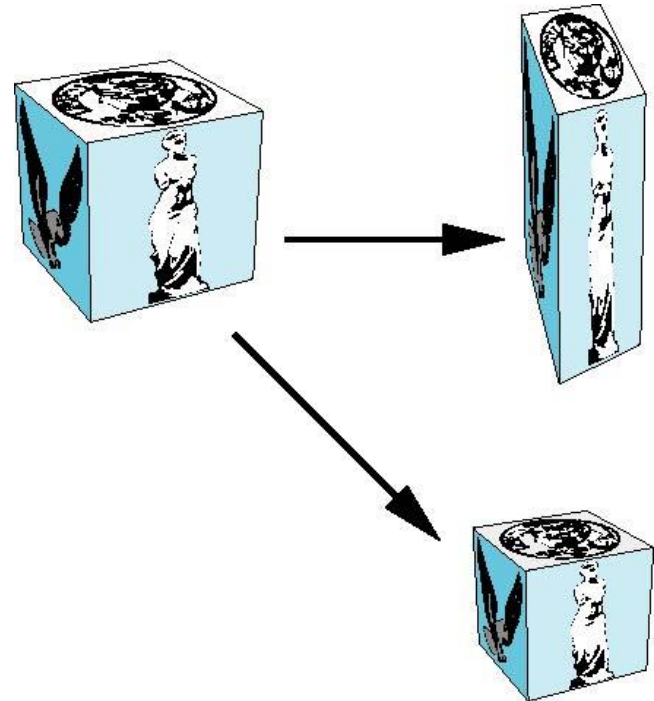

Scaling



Scale object = Move each object vertex by scale factor $S = (S_x, S_y, S_z)$
Expand or contract along each axis (relative to origin)

$$x' = S_x x$$

$$y' = S_y y$$

$$z' = S_z z$$

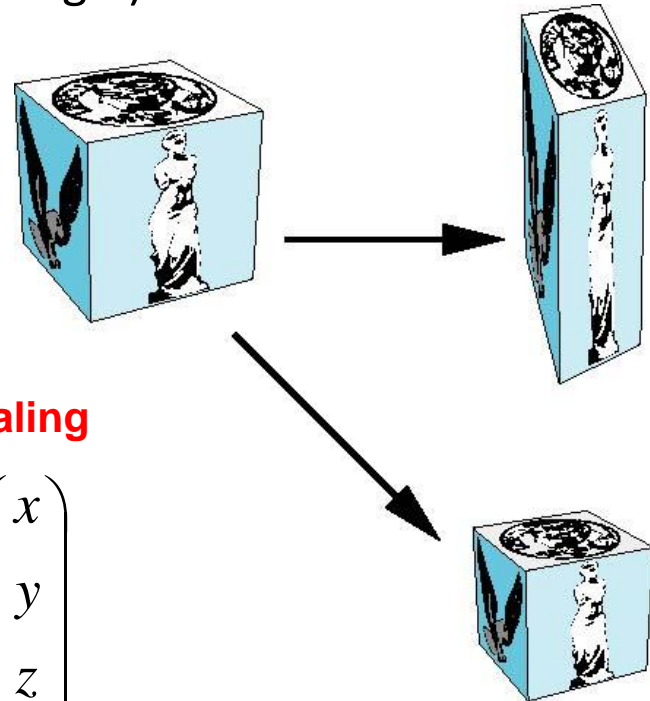

Using matrix multiplication for scaling

$$\begin{pmatrix} x' \\ y' \\ z' \\ 1 \end{pmatrix} = \begin{pmatrix} S_x & 0 & 0 & 0 \\ 0 & S_y & 0 & 0 \\ 0 & 0 & S_z & 0 \\ 0 & 0 & 0 & 1 \end{pmatrix} \times \begin{pmatrix} x \\ y \\ z \\ 1 \end{pmatrix}$$

Scale Matrix

Scale(S_x, S_y, S_z)

Shearing

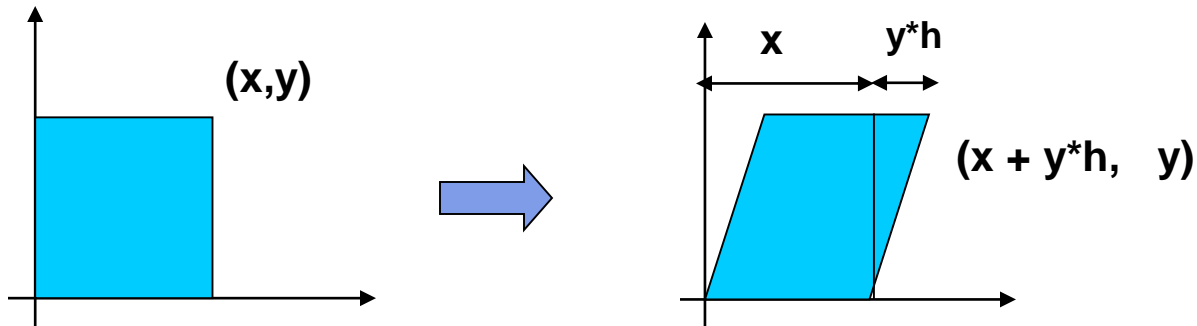

- Y coordinates are unaffected, but x coordinates are translated linearly with y
- That is:
 - $y' = y$
 - $x' = x + y * h$

$$\begin{pmatrix} x' \\ y' \\ 1 \end{pmatrix} = \begin{pmatrix} 1 & h & 0 \\ 0 & 1 & 0 \\ 0 & 0 & 1 \end{pmatrix} * \begin{pmatrix} x \\ y \\ 1 \end{pmatrix}$$

■ h is fraction of y to be added to x

3D Shear

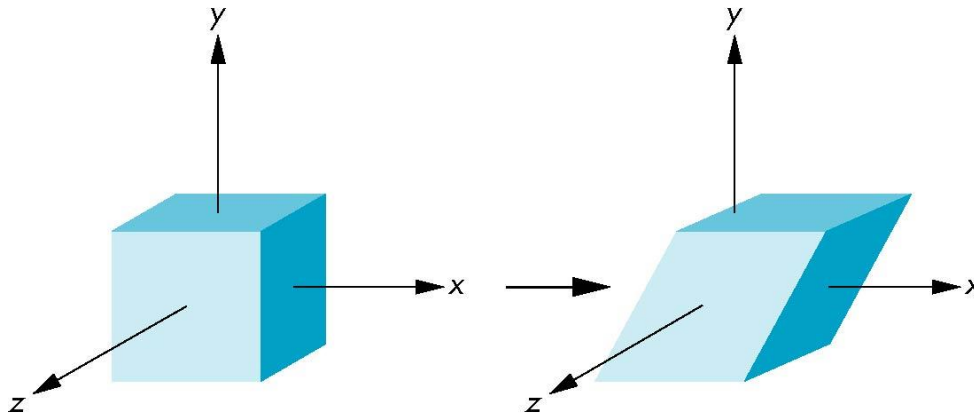
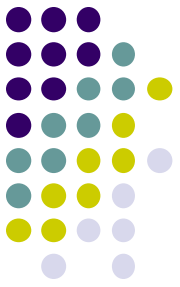

Reflection

- corresponds to negative scale factors

$$\begin{pmatrix} S_x & 0 & 0 & 0 \\ 0 & S_y & 0 & 0 \\ 0 & 0 & S_z & 0 \\ 0 & 0 & 0 & 1 \end{pmatrix}$$

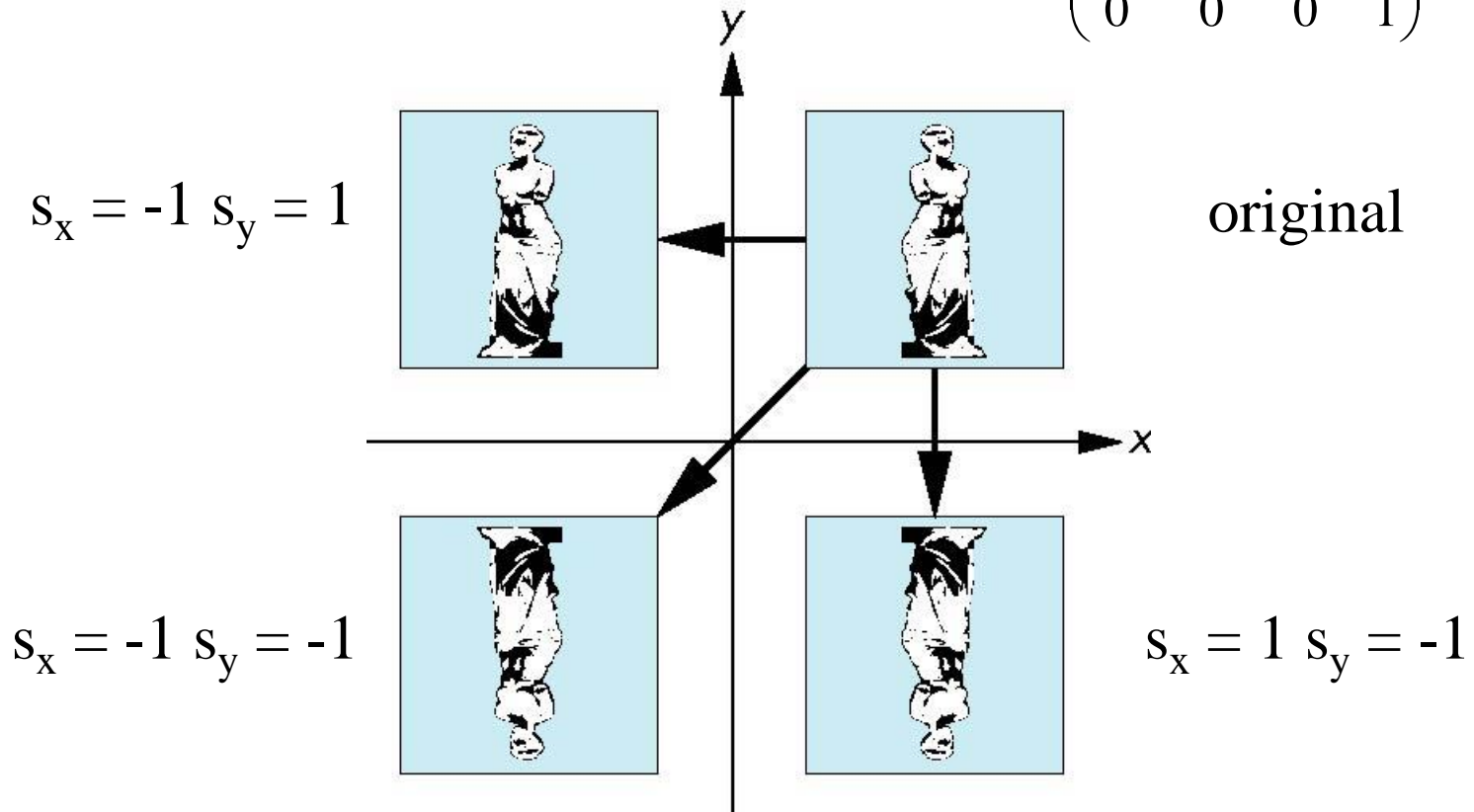
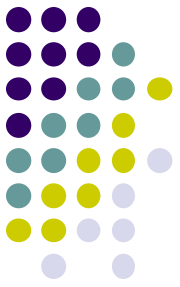

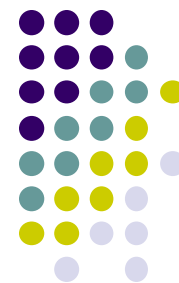

References

- Angel and Shreiner, Chapter 3
- Hill and Kelley, Chapter 5