

**Second Annual International Conference
Mobile Computing and Networking
(MobiCom'96), Rye, New York,
USA,
November 1996.**

Mobility Support in IPv6

**Charles E. Perkins
&
David B. Johnson**

**Presented By:
Ajay Sharma.**



About The Author

Charles E. Perkins: Research Fellow at Nokia Research Center investigating mobile wireless networking and dynamic configuration protocols. He is the editor for several ACM and IEEE journals for areas relating to wireless networking. Charles has served on the Internet Architecture Board (IAB) and on various committees for the National Research Council. He has published a number of papers and award-winning articles in the areas of mobile networking, resource discovery, and automatic configuration for mobile computers.

David B. Johnson: Associate Professor of Computer Science and Electrical and Computer Engineering at Rice University . He was a principal designers of the IETF Mobile IP protocol for IPv4 and primary designer of Mobile IP for IPv6. Currently an Executive Committee member and the Treasurer for SIGMOBILE, also a member of the Editorial Board for IEEE/ACM Transactions on Wireless Networks.



Outline

1. **Why Mobile IPv6**
2. **Benefits of Mobile IPv6**
3. **What is IPv6?**
4. **Address Architecture of IPv6.**
5. **Mobile IPv6 Terminology.**
6. **Mobile IPv6 Mechanism.**
7. **Errors Handling**
8. **Security Handling**
9. **Summery**
10. **Q & A**



Why Mobile IPv6? -- Propellant factors.

- **Huge growth of mobile Internet terminals will exhaust IPv4 address space**
 - All wireless terminals will have WAP and GPRS
 - IPv6 brings enough IP addresses
- **Ease of scalability**
 - Supporting billions of new devices and huge amounts of new bandwidth
 - Simplified, cost-efficient architecture without NATs , Proxies, ALGs,...
- **Always-on connection establishes a variety of new services.**
 - Push, location-based, etc.
- **Integrated Security**
- **Efficiency: IPv6 improves efficiency in a number of areas.**
 - Routing, Broadcast handling
- **Quality of Service improvements**
 - Fragmentation, Flows
- **Mobility Across Access Technologies**

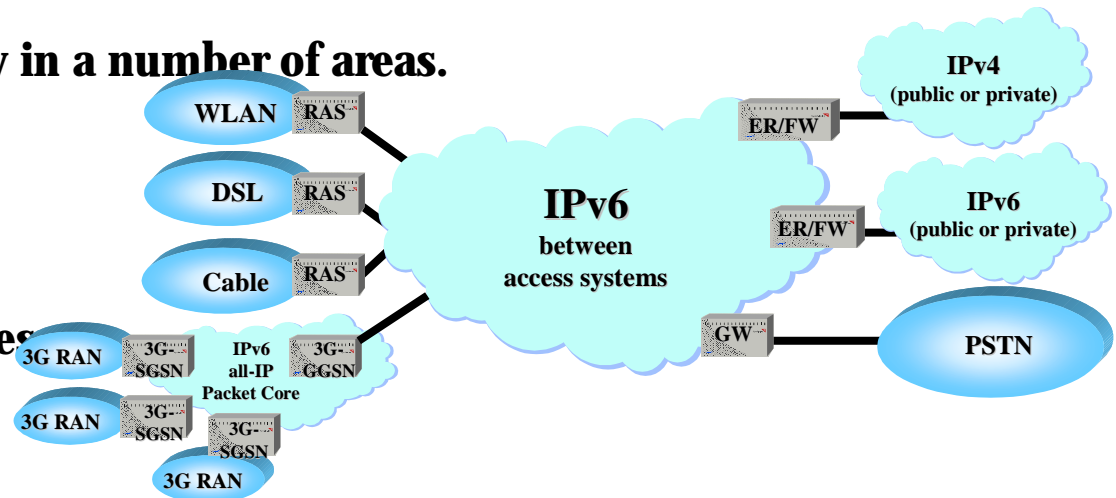

Requirements for Mobility in Internet

Mobility

- **Increasing number of users asks for Mobility Support in Internet**

Transparency

- **Mobility shall be transparent to all Protocol Layers above IP**

Easy to use

- **Mobility shall be as easy to handle as with Mobile Phones in GSM**

Routing

- **Mobility shall be compatible to all Routing Protocols and shall optimize routes**

Security

- **Mobility shall not decrease security in Internet**



IPv6 features relevant to Mobile IP

- **Larger address space => Unique Global address for each device. ($6.65 \cdot 10^{23}$ addresses per m^2 of earth surface)**
- **Scalable => Run over multiple media i.e. Wireless-LAN, Ethernet, 3G**
- **Auto configuration capabilities=> Network Plug-and-Play.**
- **Fixed header format => Fewer fields (8 as compared to 12 in IPv4)**
- **Router headers => MIP updates are in extension headers. No header length anymore.**
- **Security extensions => Internet level Security in IPv6 Header.**
- **Anycast addresses => Special type of address in IPv6.**
- **Encapsulation => IP-layer authentication & encryption possible.**
- **Quality of service and flow labels => efficient routing for real-time applications.**
- **Elimination of “triangle routing” for mobile IP**
- **All nodes can handle bindings.**
- **Small overhead for distributing bindings. Fixed header format**
- **option extension headers not parsed by intermediate routers anymore**



Basic IPv6 Address Types

unicast:

for one-to-one communication



multicast:

for one-to-many communication

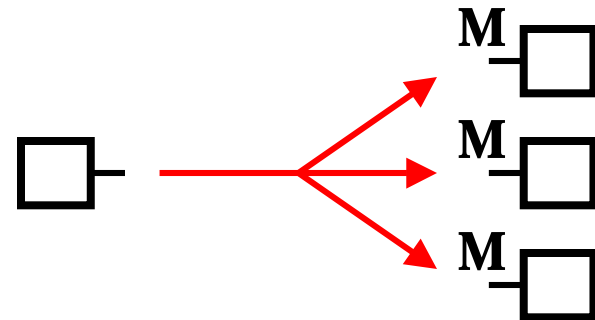

anycast:

for one-to-nearest communication

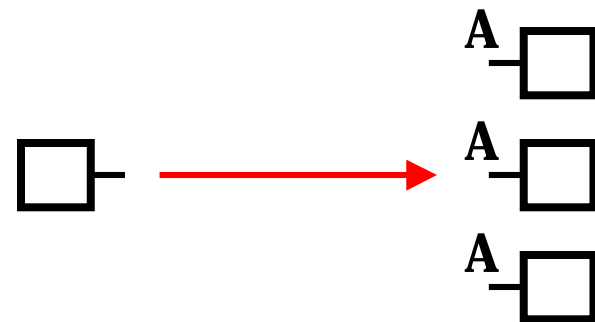

IPv6 - Addressing Model

- addresses are assigned to interfaces
 - No change from IPv4 Model
- interface 'expected' to have multiple addresses
- addresses have scope
 - Link Local
 - Site Local
 - Global
- addresses have lifetime
 - Valid and Preferred lifetime

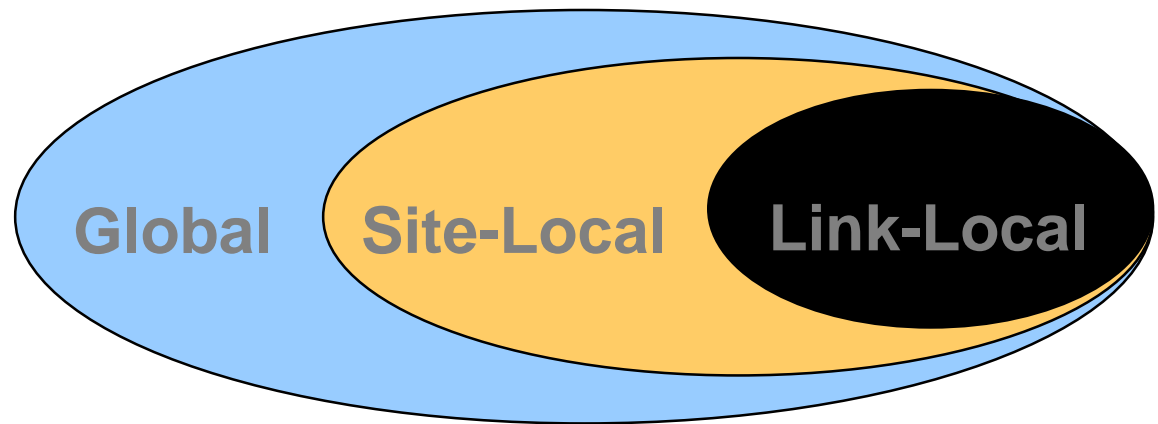

Text Representation of IPv6 Address

“Preferred” form: 1080:0:FF:0:8:800:200C:417A

Compressed form: FF01:0:0:0:0:0:0:43 becomes FF01::43

IPv4-compatible: 0:0:0:0:0:0:13.1.68.3 or ::13.1.68.3

There is no broadcast addresses, only multicast.

Loopback address is ::1



Internet Registry Hierarchy

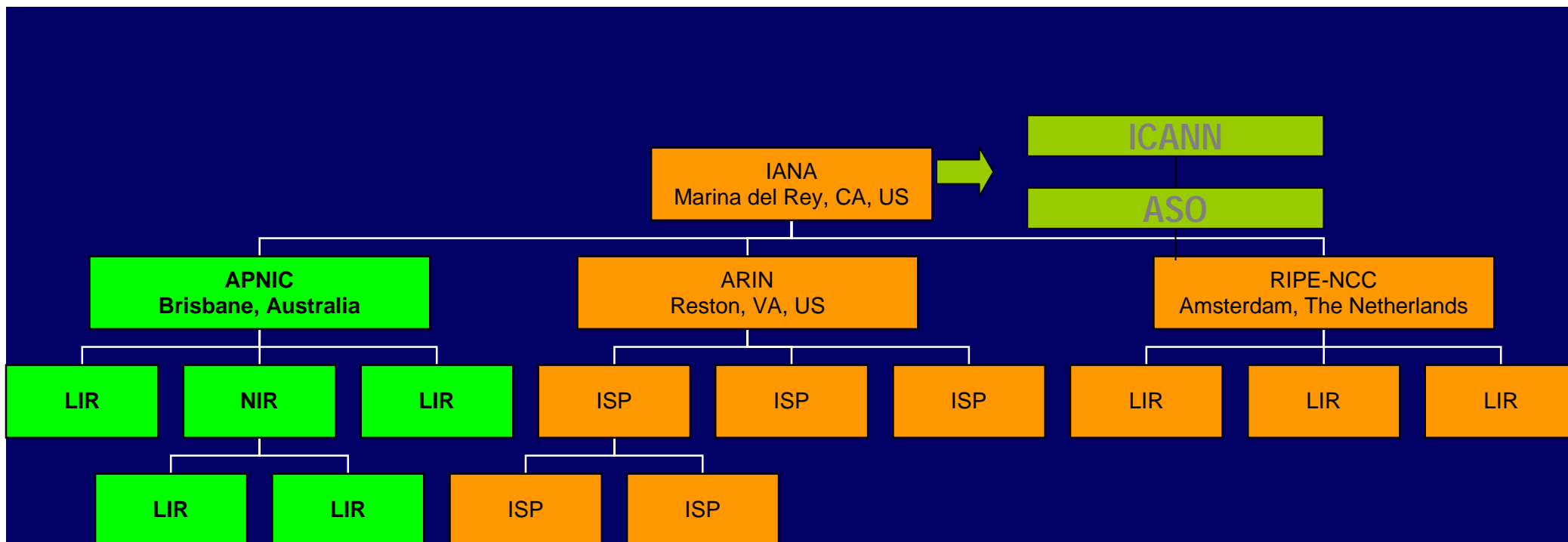

- **ICANN:** The Internet Corporation for Assigned Name and Number
- **ASO:** Address Supporting Organization.
- **IANA:** Internet Assigned Number Authority.
- **ARIN:** American Registry for Internet Number.
- **APNIC:** Asia Pacific Network Information Centre.
- **RIPE-NCC:** Reseaux IP Europeene.



IPv6 Address Formats

Aggregatable Global Unicast Address

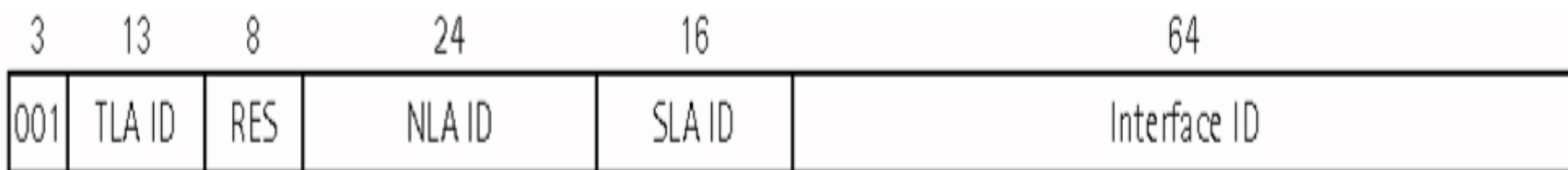

Address Format with Field Substructures

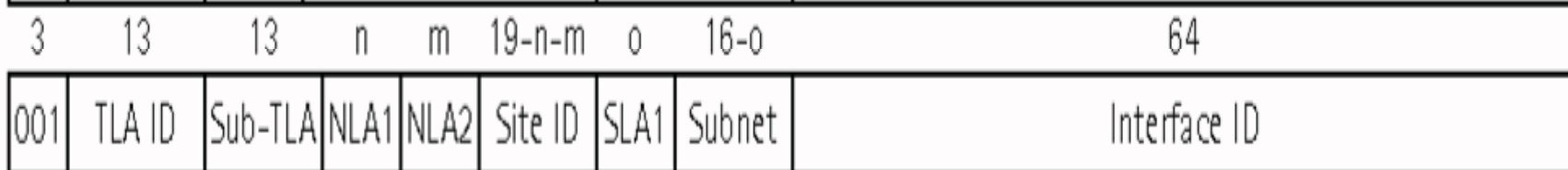

Link-Local Unicast Address

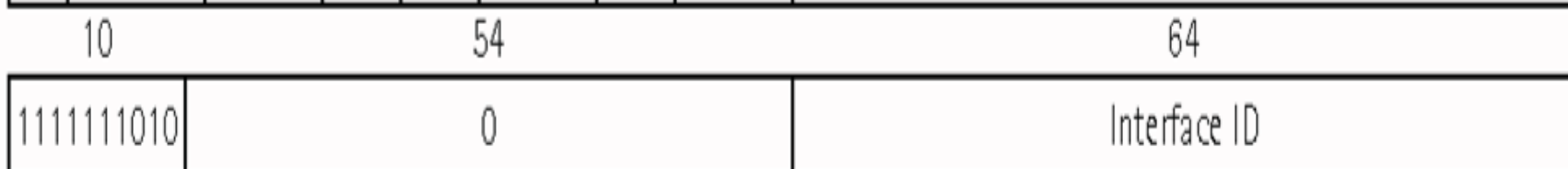

Site-Local Unicast Address

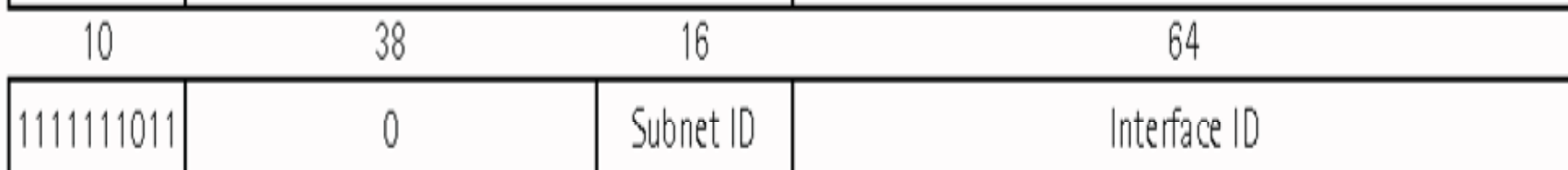

Reserved Subnet Anycast Address

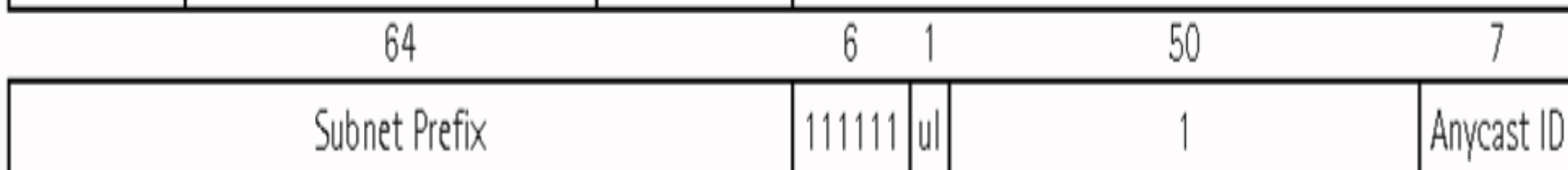

Multicast Address

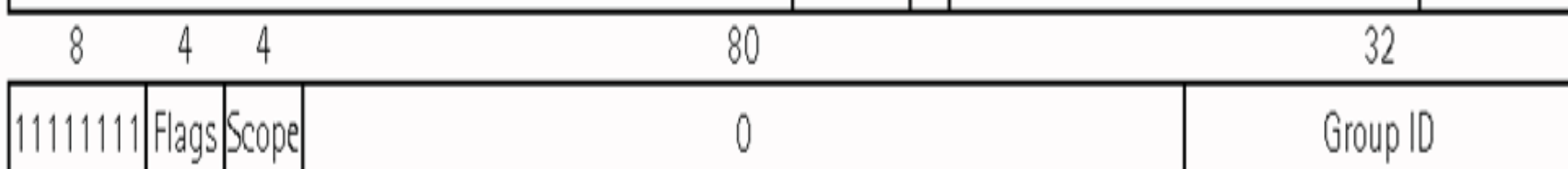

Multicast address

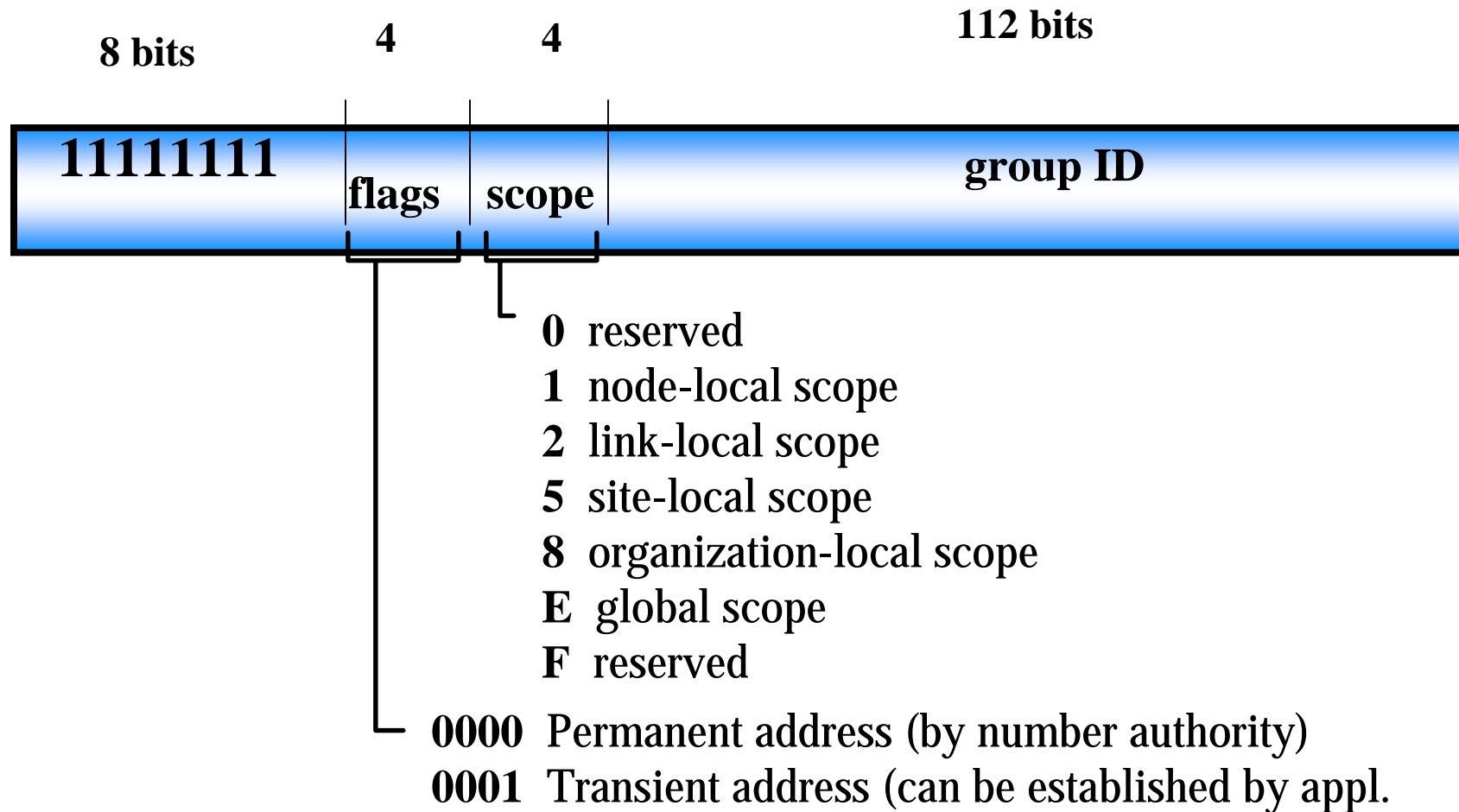

IPv4 vs. IPv6 Header

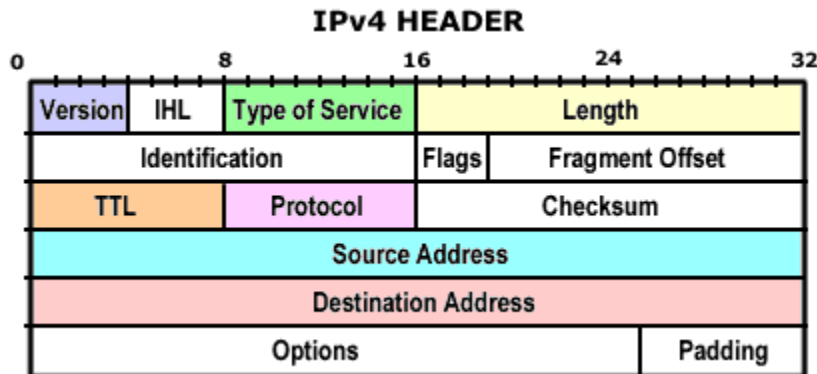

- 14 fields, at least 20 octets
- 32 bit addresses
- fragmented packet processing at every hop
- header checksum recalculation at every hop
- variable Options field for extra processing information

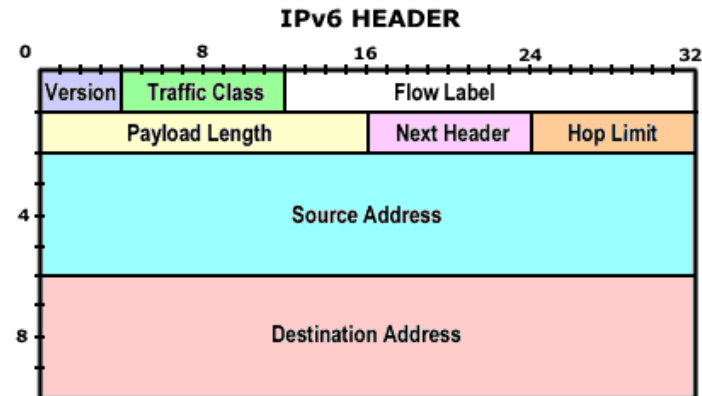

- 8 fields, fixed 40 octet size
- 128 bit addresses
- fragmentation only in src and dst endpoint, or lower layer
- no checksums
- new 20 bit flow label field
- options in Extension Headers



Changes in IPv4 Header

- 20 bytes
- 13 fields
- removed
- moved to extension headers
- renamed
 - precedence → class
 - total length → payload length
 - time to live → hop limit
 - protocol → next header

Version	Hdr Len	Precedence	ToS	Total Length	
Identification				Flags	Fragment Offset
Time To Live		Protocol		Header Checksum	
Source Address					
Destination Address					



IPv6 Header Simplifications

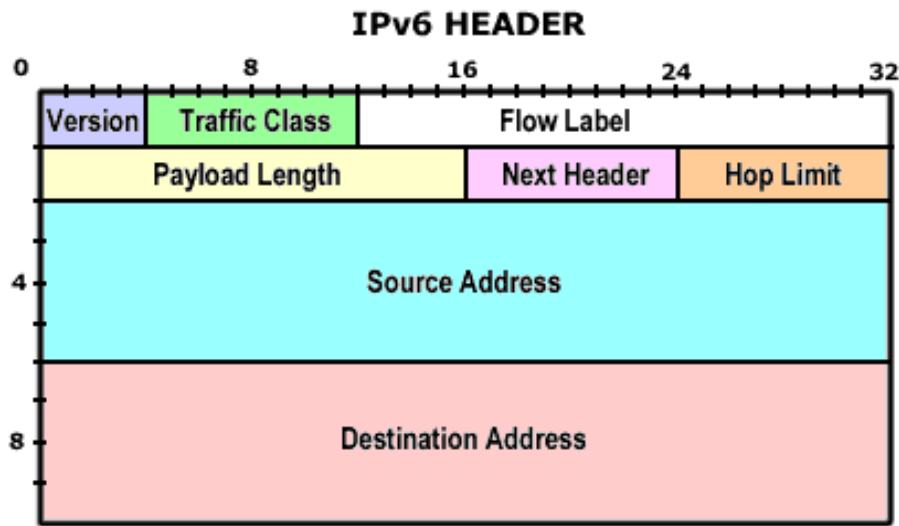

- **Base header is fixed size - 40 octets**
 - **NEXT HEADER field in base header defines type of header**
 - **Appears at end of fixed-size base header**
- **Some extensions headers are variable sized**
 - **NEXT HEADER field in extension header defines type**
 - **HEADER LEN field gives size of extension header**

Simplifications

Fixed format headers

no options -> no need for header length options expressed as Extension headers

No header checksum

**reduce cost of header processing, no checksum updates at each router
minimal risk as encapsulation of media access protocols (e.g...., Ethernet, PPP) have checksum**

No segmentation

hosts should use path MTU discovery otherwise use the minimum MTU (536 bytes)



Extension Header

Store optional internet-layer information [Placed between IPv6 header and upper-layer header]

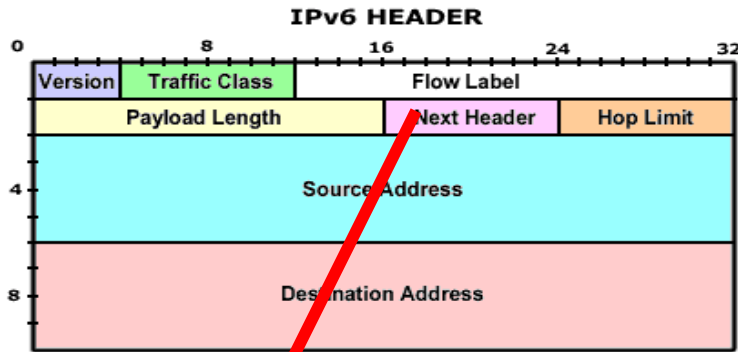

The Next Header field points to an extension Header

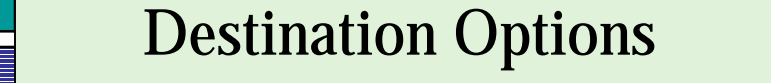
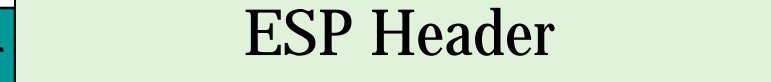
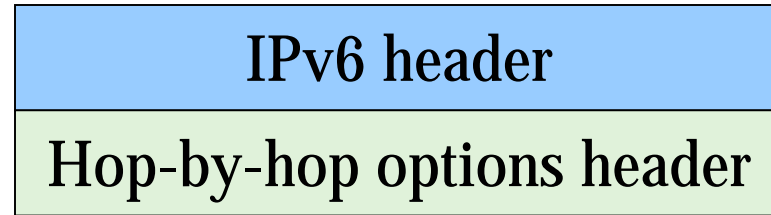
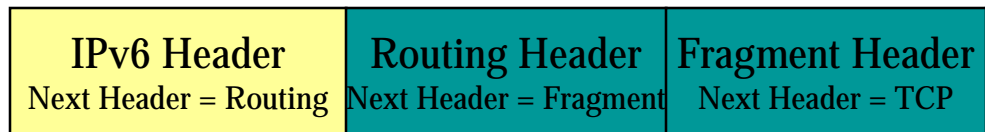
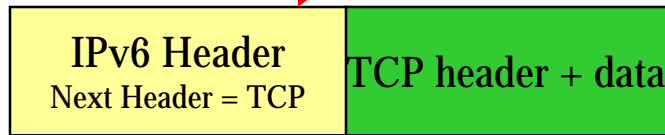

Extension Header



Carries optional information that must be examined by every node along the packet's delivery path.

Contains more information than the IPv6 header. Discovery process is used to determine smallest allowed packet size.

Does not give authentication for IP header fields that change value along route.
 Alice is Alice, Bob is Bob (AH)

Supports data confidentiality.
 Charlie can't read Alice or Bob's Message (ESP)



Terms used in Mobile IPv6

Mobile Node	Node, which can change its access point to the Internet while still being reachable under its Home Address.
Home Address	Static IP Address of the Mobile Node valid at its home network.
C/o-Address	Temporary IP Address of the Mobile Node valid at the actually visited network of the Mobile Node (c/o = care-of).
Binding	Association of the Home Address with the c/o-Address.
Home Agent	Router located at the Mobile Node's home network used by the Mobile Node for registering its c/o-Address.
Binding Cache	Cache for received Bindings.



Binding Update Option Header Format

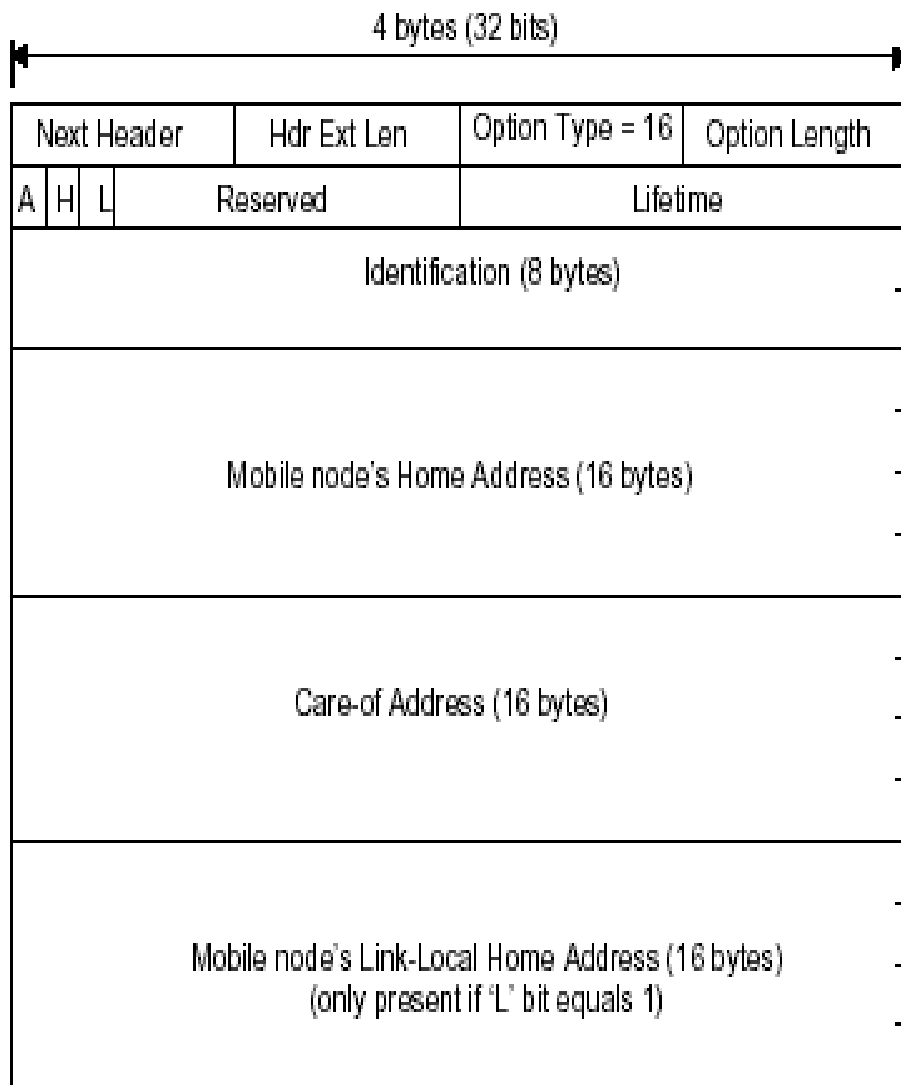

A Bit : Indicates whether receiver should reply or not with Binding Acknowledgement.

H Bit: Use when mobile node wants the receiving node to act a Home Agent.

L Bit: Set if the mobile node want to receive packet destined to its link-local address.

Lifetime: Lease time for the address.

Identification Field: Counter is use to insure Binding Updates are order-wise. Counter increment for each new BU (not for retransmission) .

Care-of Address: current address of MN. When care-of address = Home address. Destination Cache entries should be deleted.



Server-less Autoconfiguration (“Plug-n-Play”)

Host autoconfiguration: Host autoconfiguration is a mechanism whereby addresses and other parameters can be assigned to network interfaces. This can be done in two different ways, known as stateful and stateless autoconfiguration. Duplicate Address Detection (DAD) is also performed here.

Router autoconfiguration: Neighbor Discovery protocol the mechanisms for automatic router configuration Keeping a router updated means ensuring that it has an exact knowledge of the organization of the subnet to which it is connected, which in turn means assigning the correct prefixes to each link with which the router has an interface.

DNS autoconfiguration: To facilitate man-machine interfacing, applications generally handle domain names rather than numerical addresses. DNS, database contains name-address mappings for each Internet domain. A6 record type has been defined facilitate the adoption of an automatic DNS management mechanism.

Service autoconfiguration : to make use of the services available on the network, users must know at least the name of the network host on which they are installed. Service Location Protocol (SLP), which provides a flexible and scalable structure whereby hosts can access information concerning the existence, location and configuration of network services.



Configuring Network Prefix

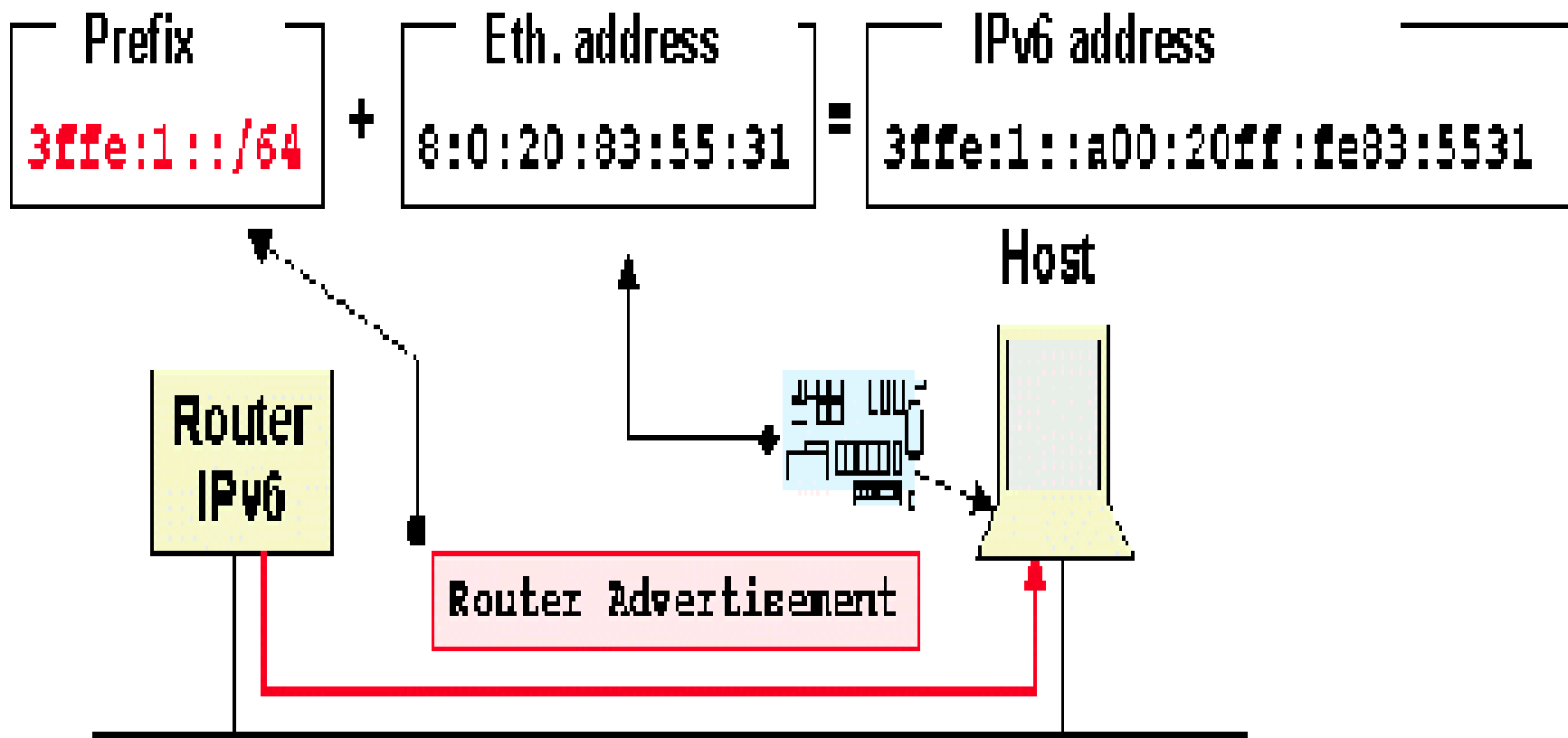

Autoconfiguration Algorithm

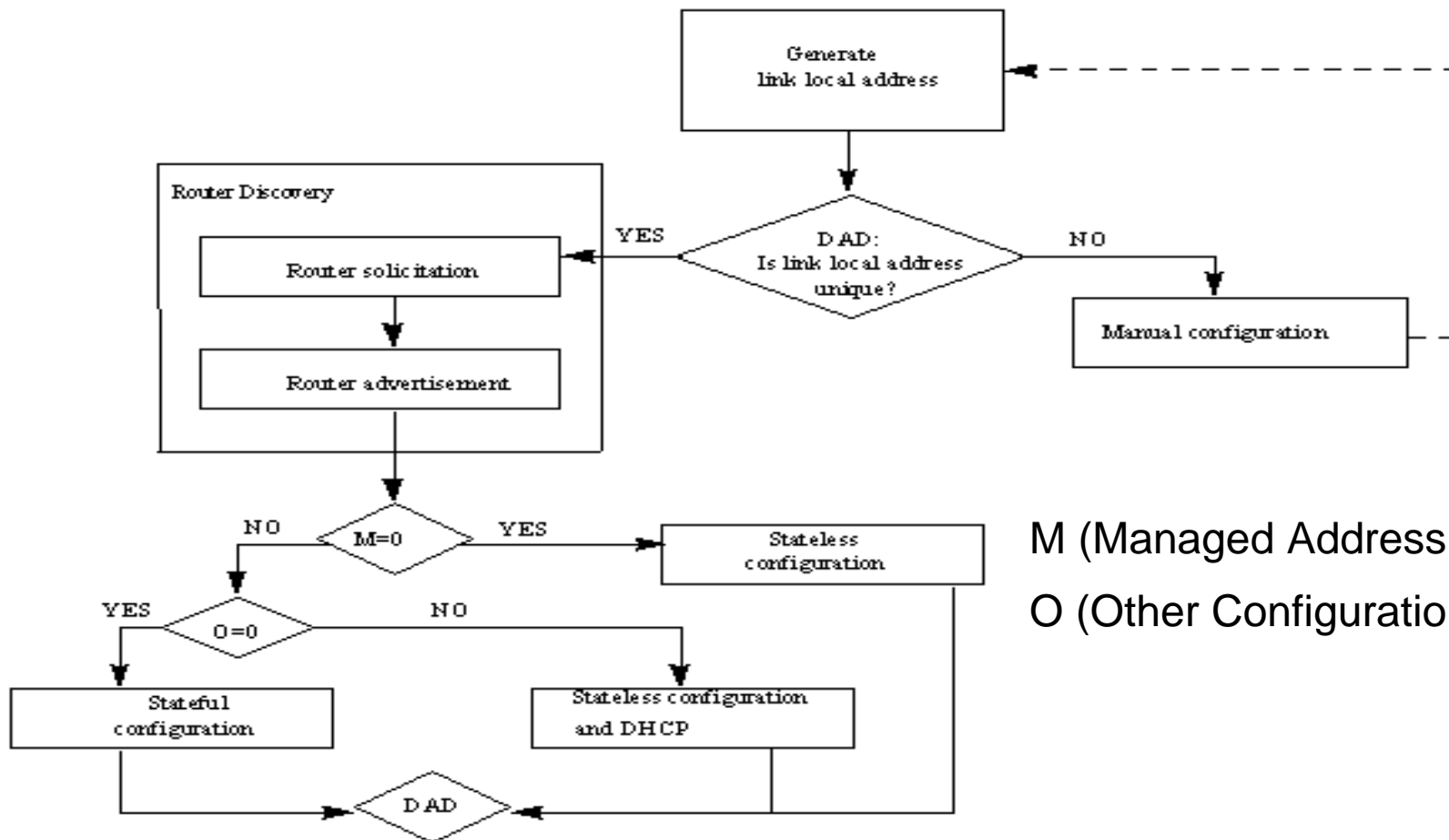

M (Managed Address Configuration)
O (Other Configuration)



Packet Transmission Algorithm

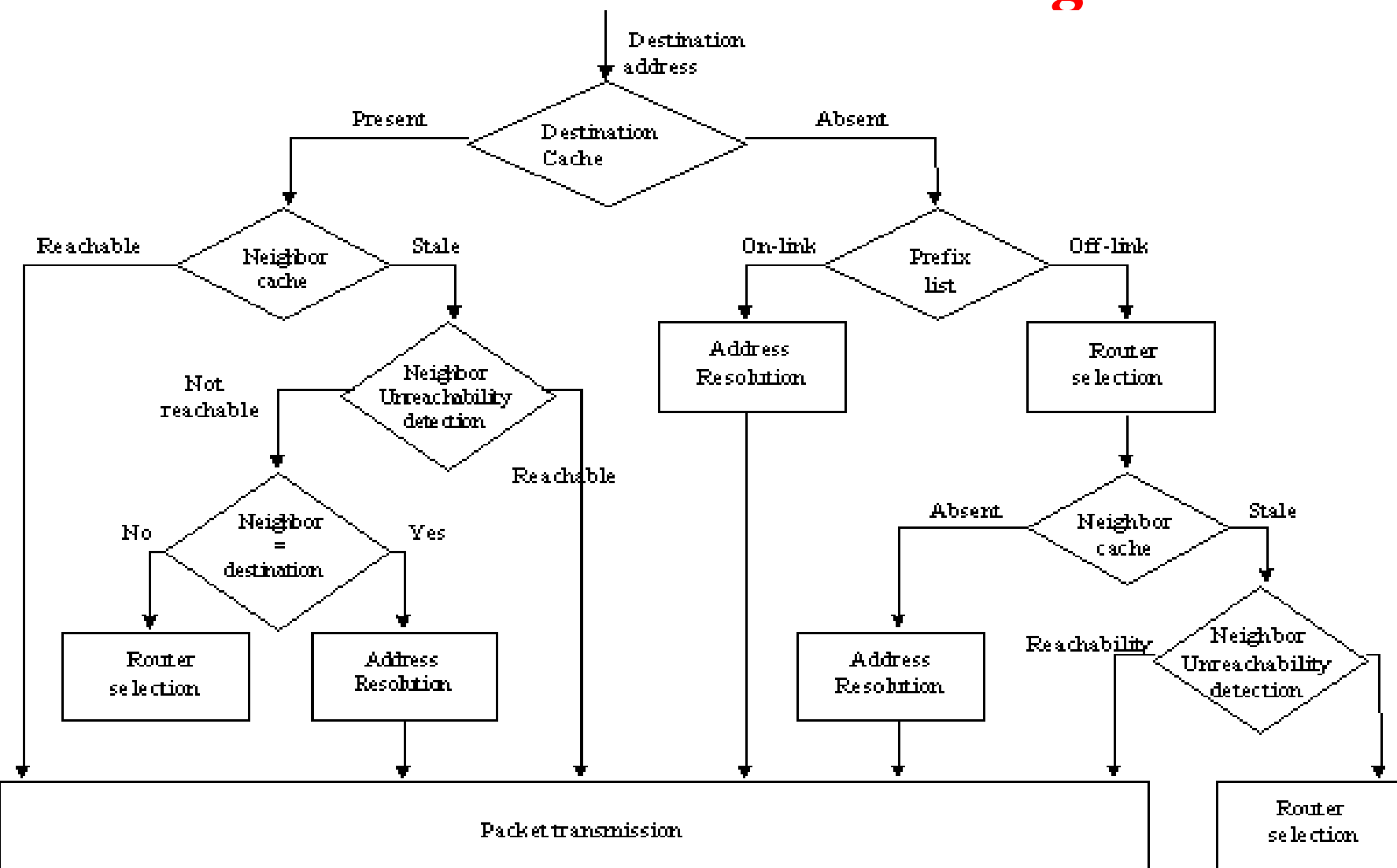

Mobility Problem with IPv4

Mobile Computer at Home Link:

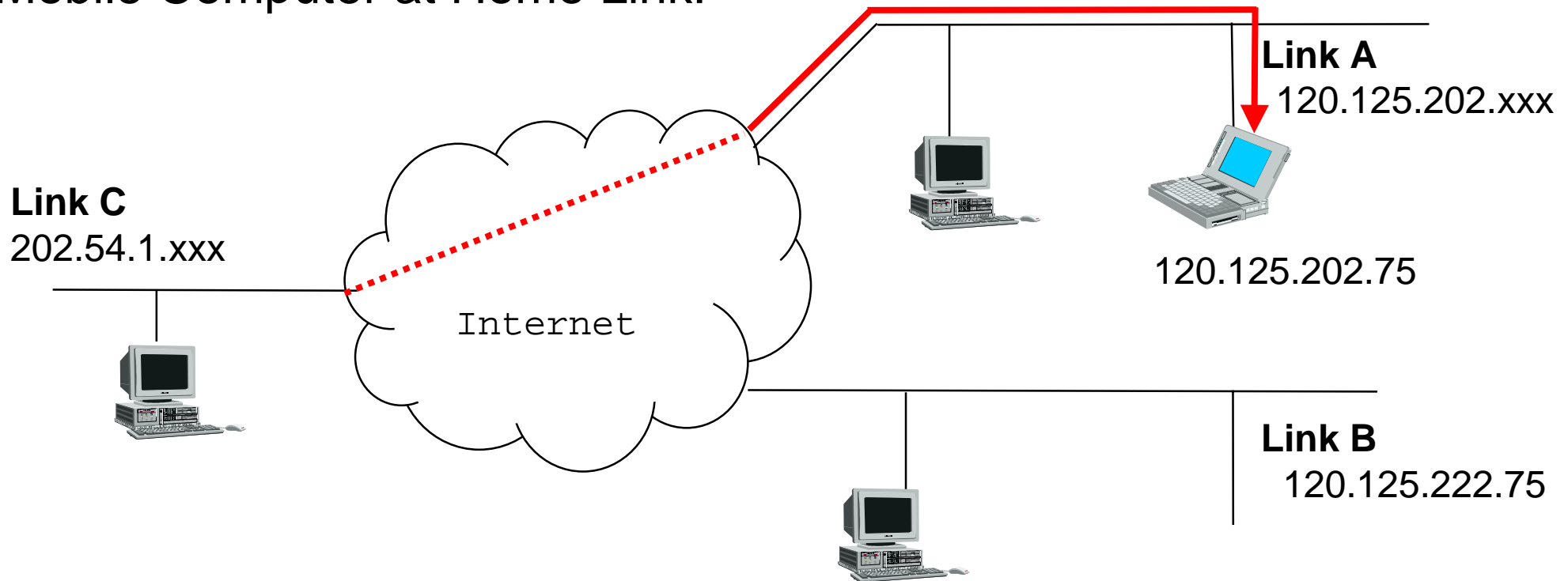

IP Mobility Problem with IPv4

Mobile Computer to Foreign Link:

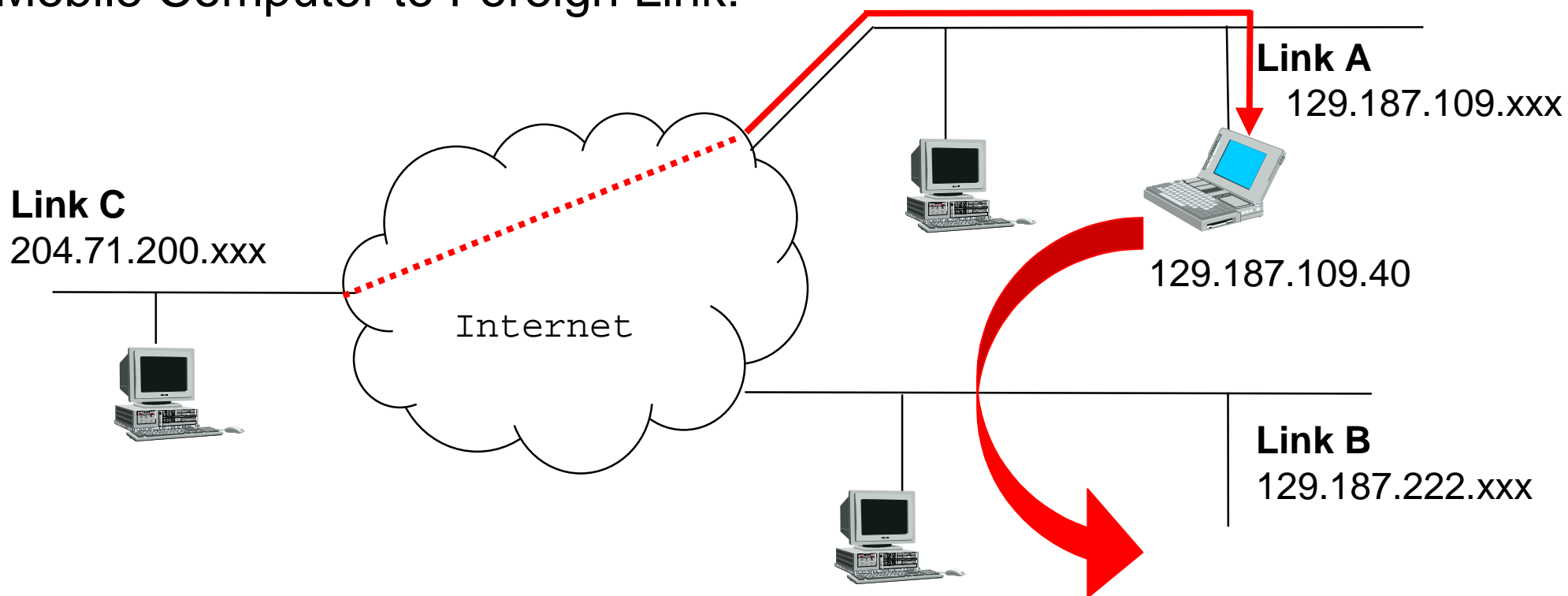

IP Mobility Problem on Movement

Mobile Computer at Foreign Link:

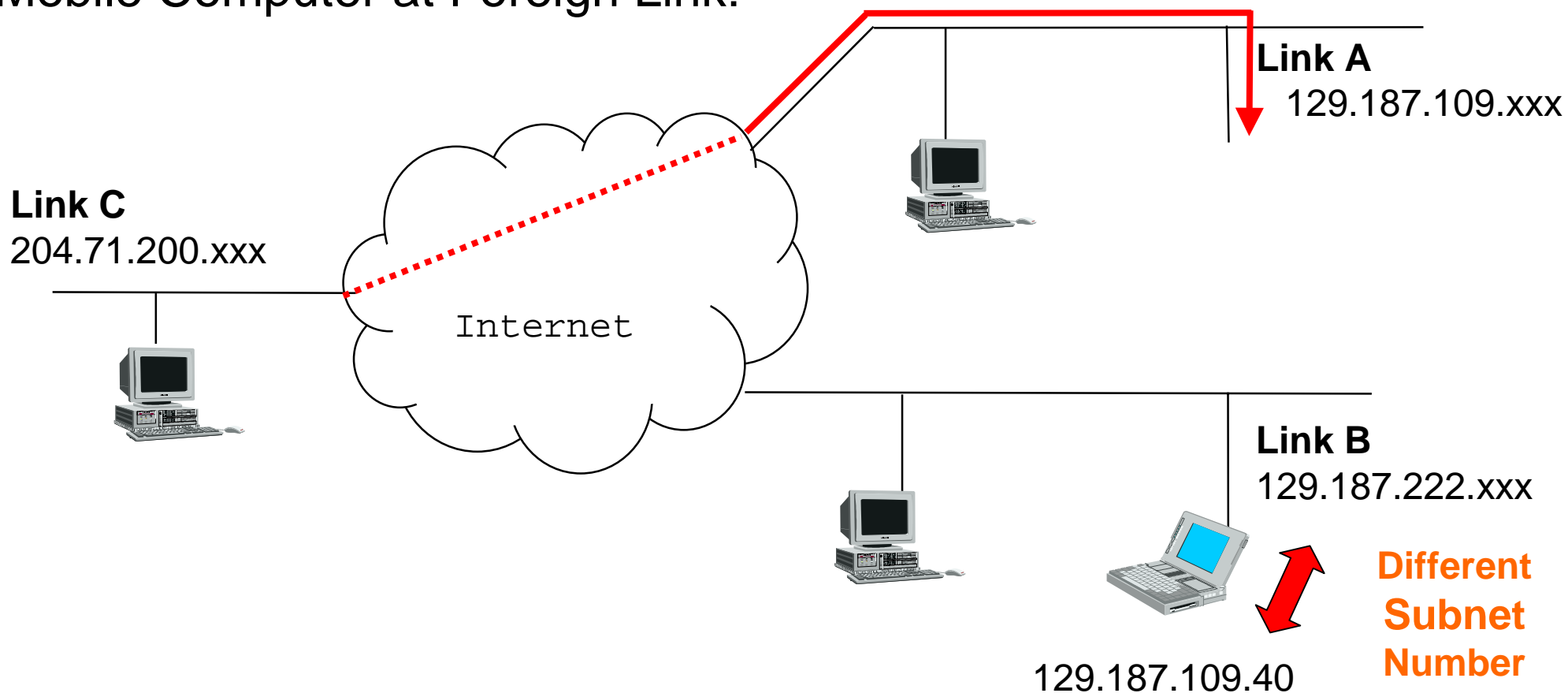

IP Mobility Problem with IPv4

Mobile Computer at Foreign Link:

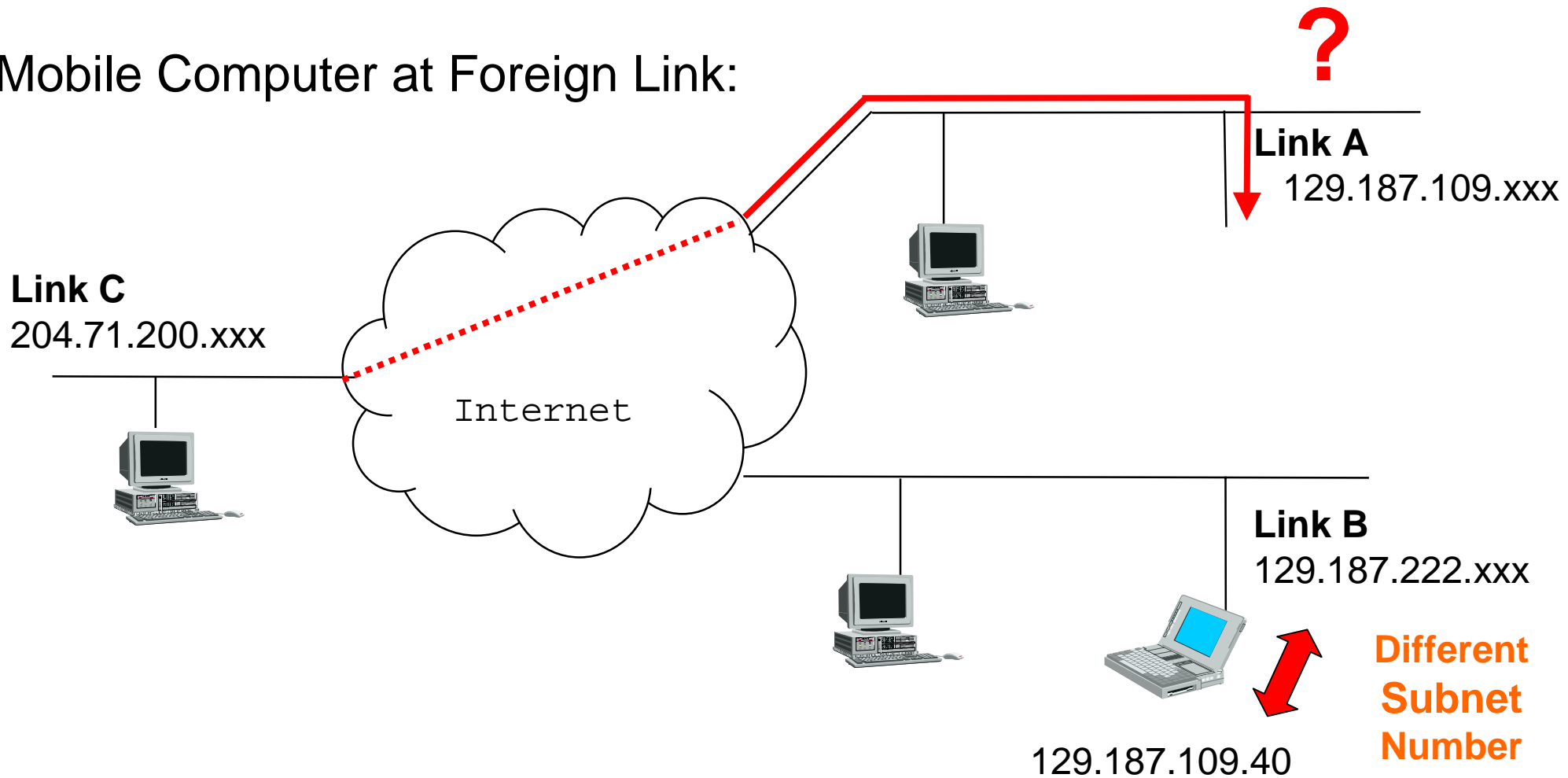

Packet Delivery with IPv4

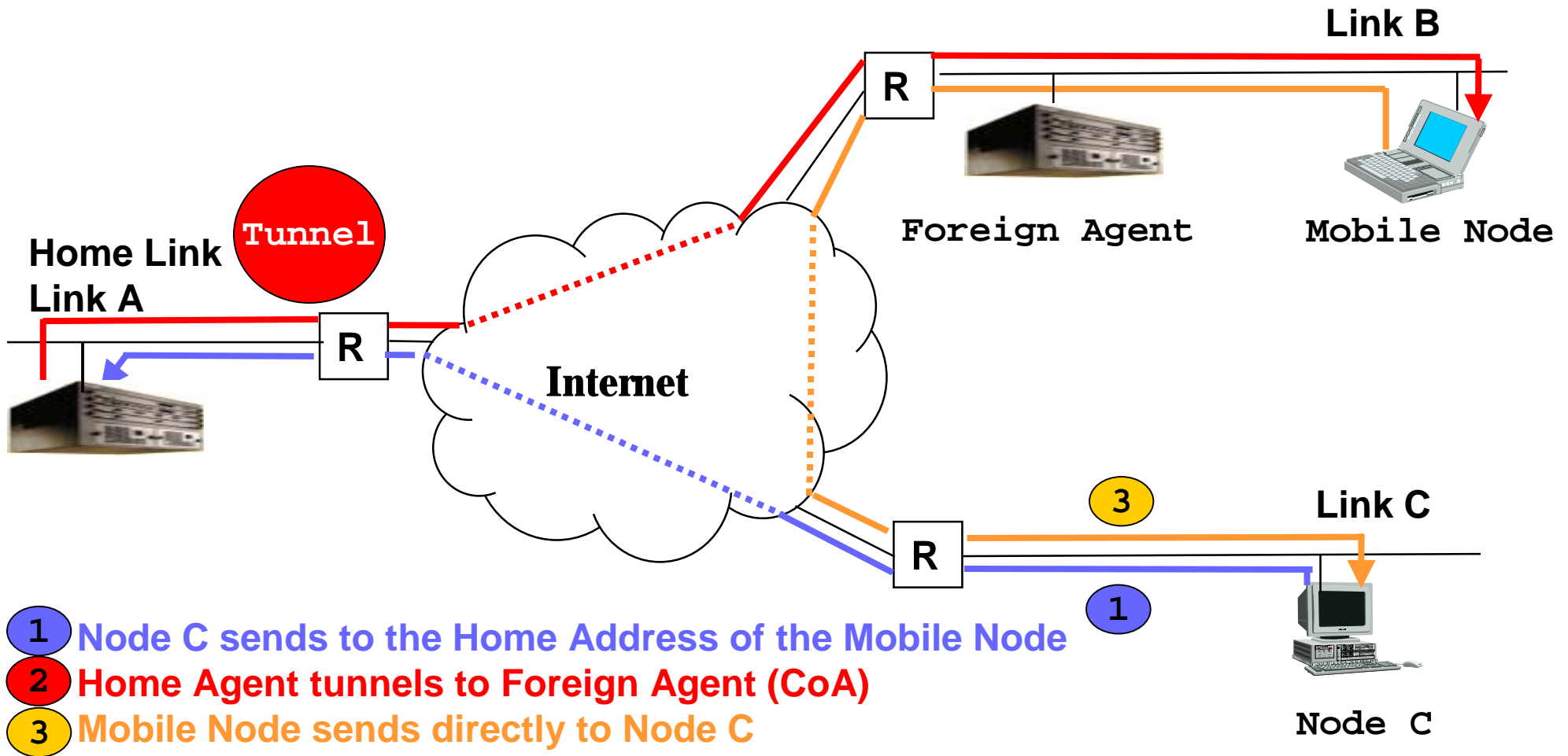

Mobile Node Moves: IPv6 consideration

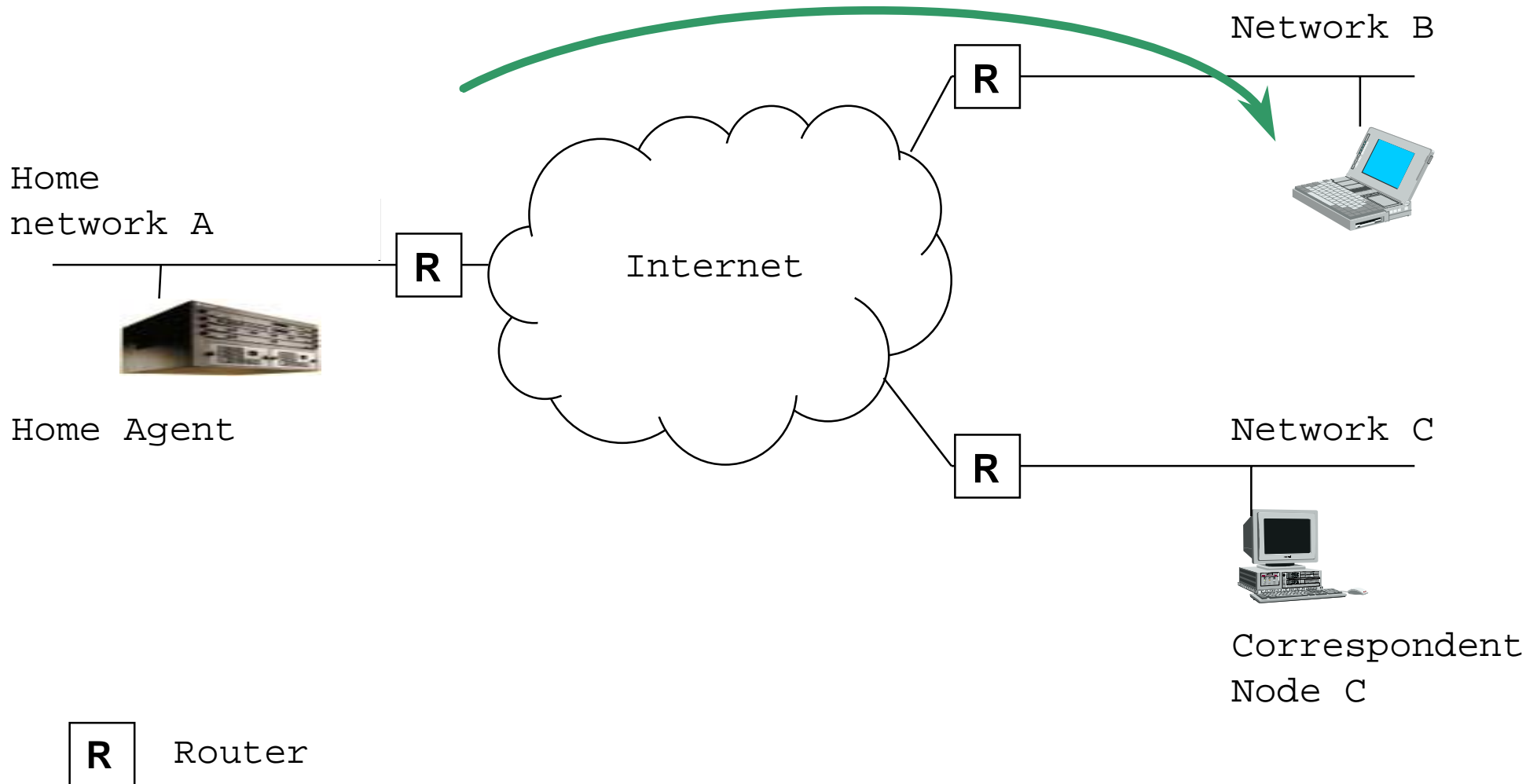

Mobile Node registers at its Home Agent

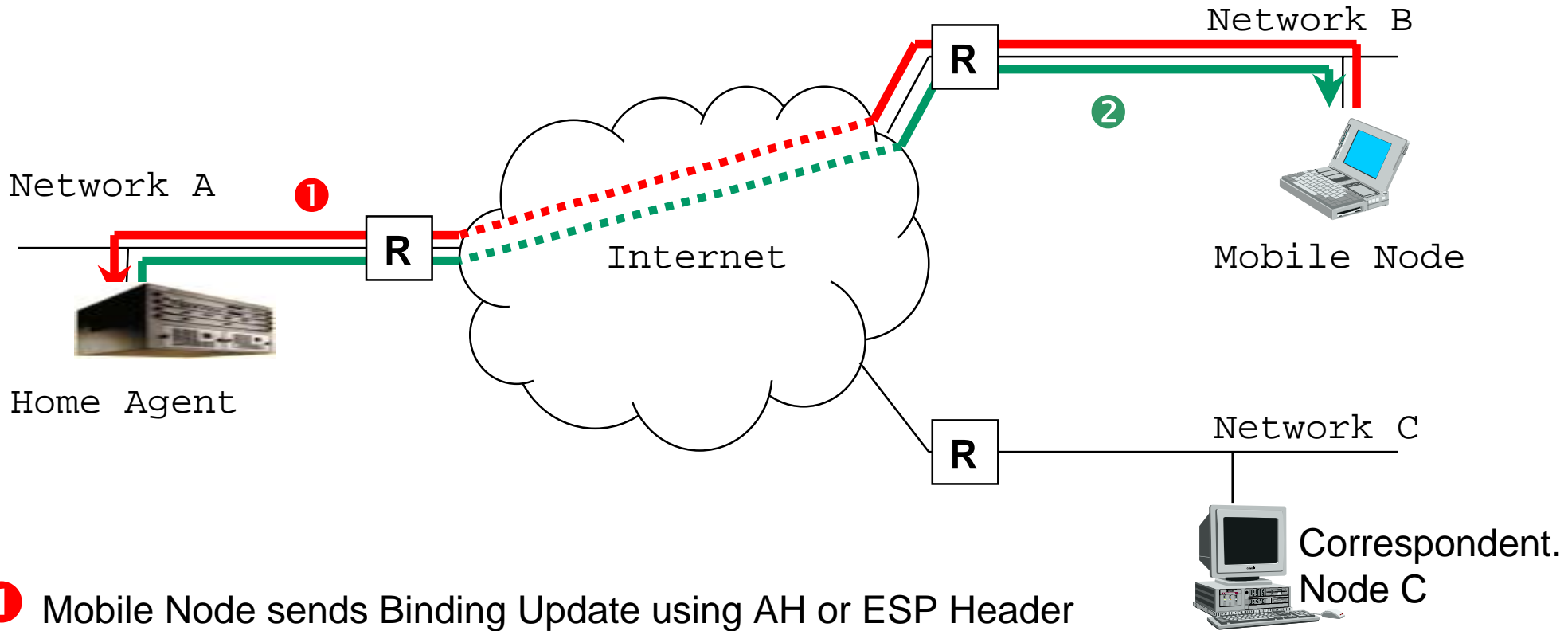

- 1 Mobile Node sends Binding Update using AH or ESP Header
- 2 Home Agent replies with Binding Acknowledgement using AH or ESP Header



Binding Request

When Mobile's Node Care-of address lease-time going to expire.



To keep Correspondent Node update.



Mobile Node
Send Binding
Update



Correspondent
Node Request
Binding Update

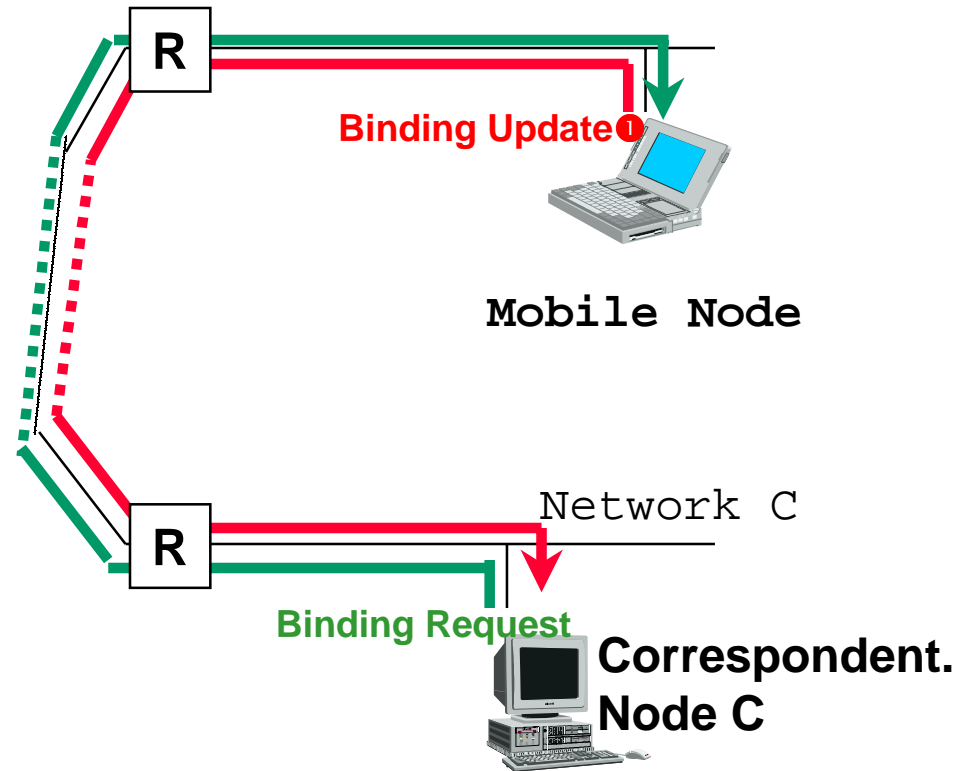

Tunneling

Tunnel: The path followed by a datagram while it is encapsulated. While encapsulated, a datagram is routed to a knowledgeable agent, which decapsulates the datagram and then forwards it to its ultimate destination.

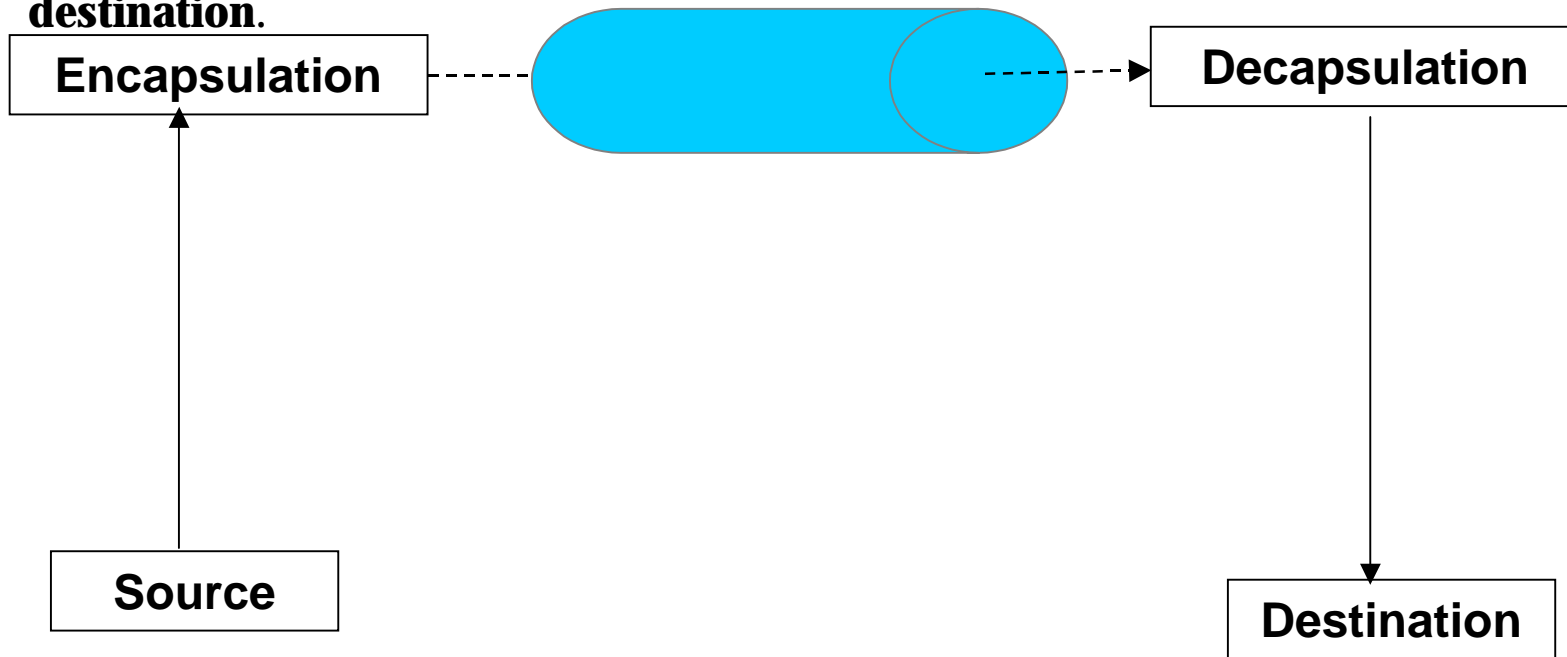

On Mobile Node Movement: HA Takes Action

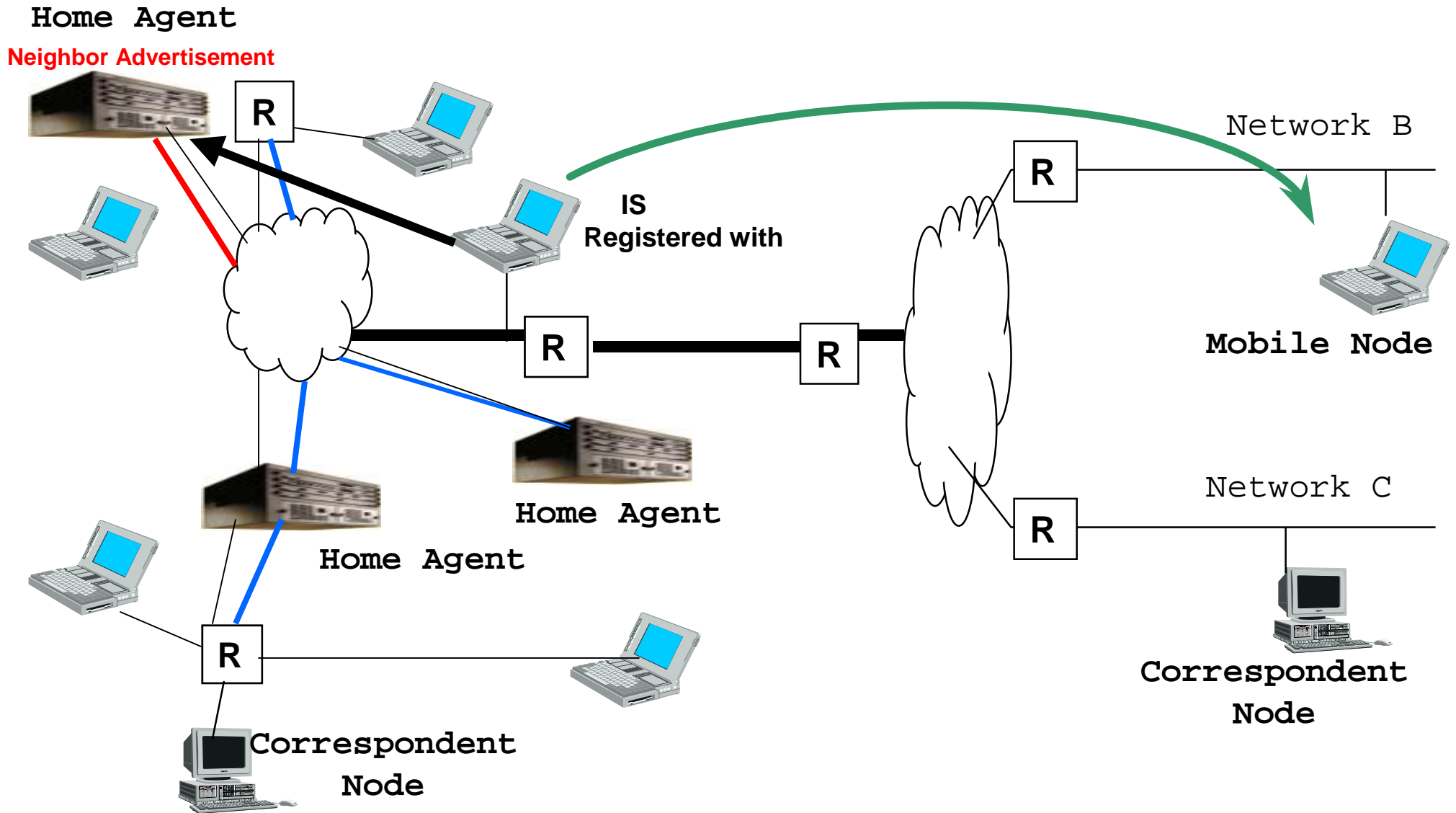

HA Takes Action: When MN Return its Home Subnet

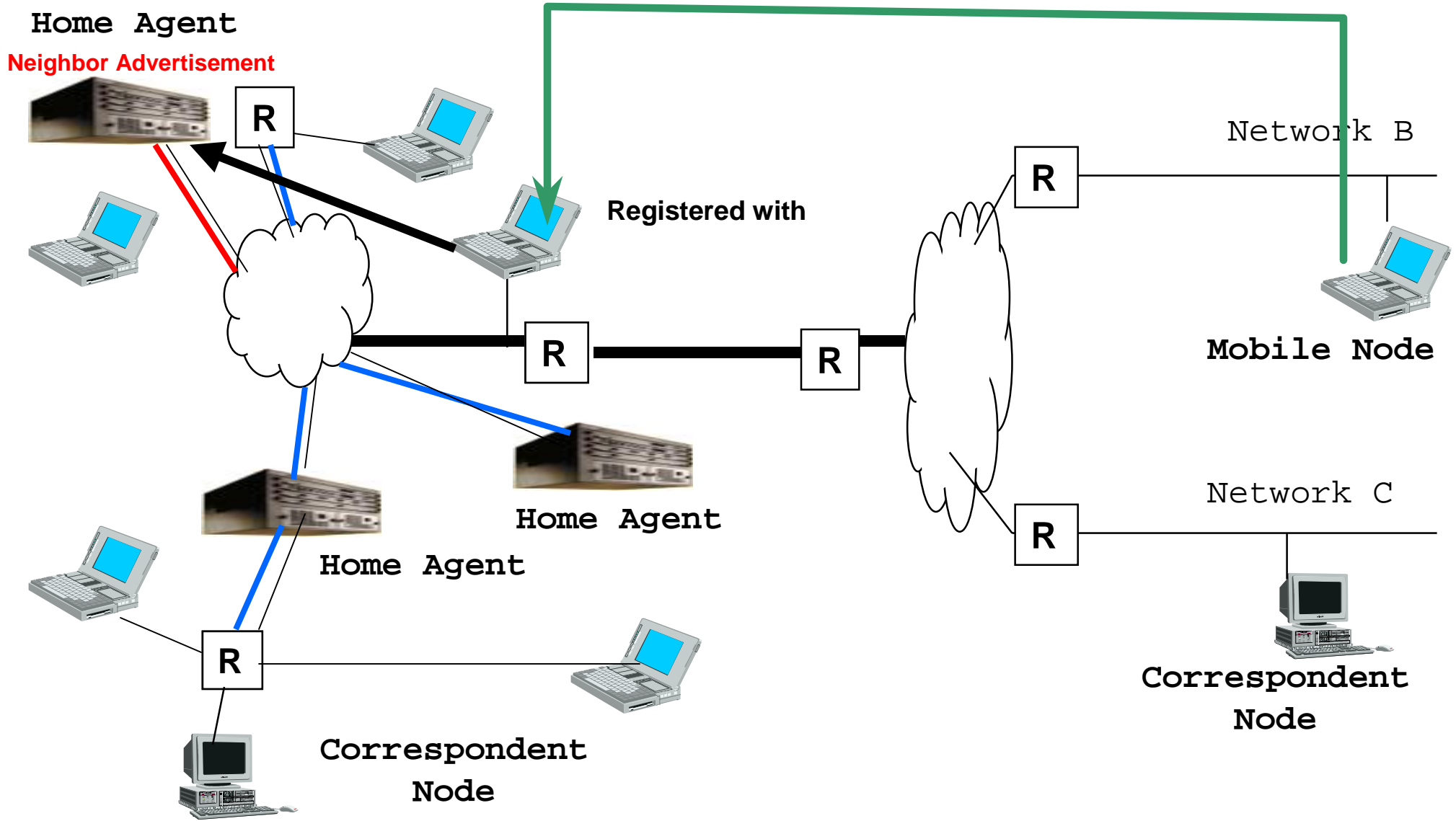

Triangular Routing during Initial Phase

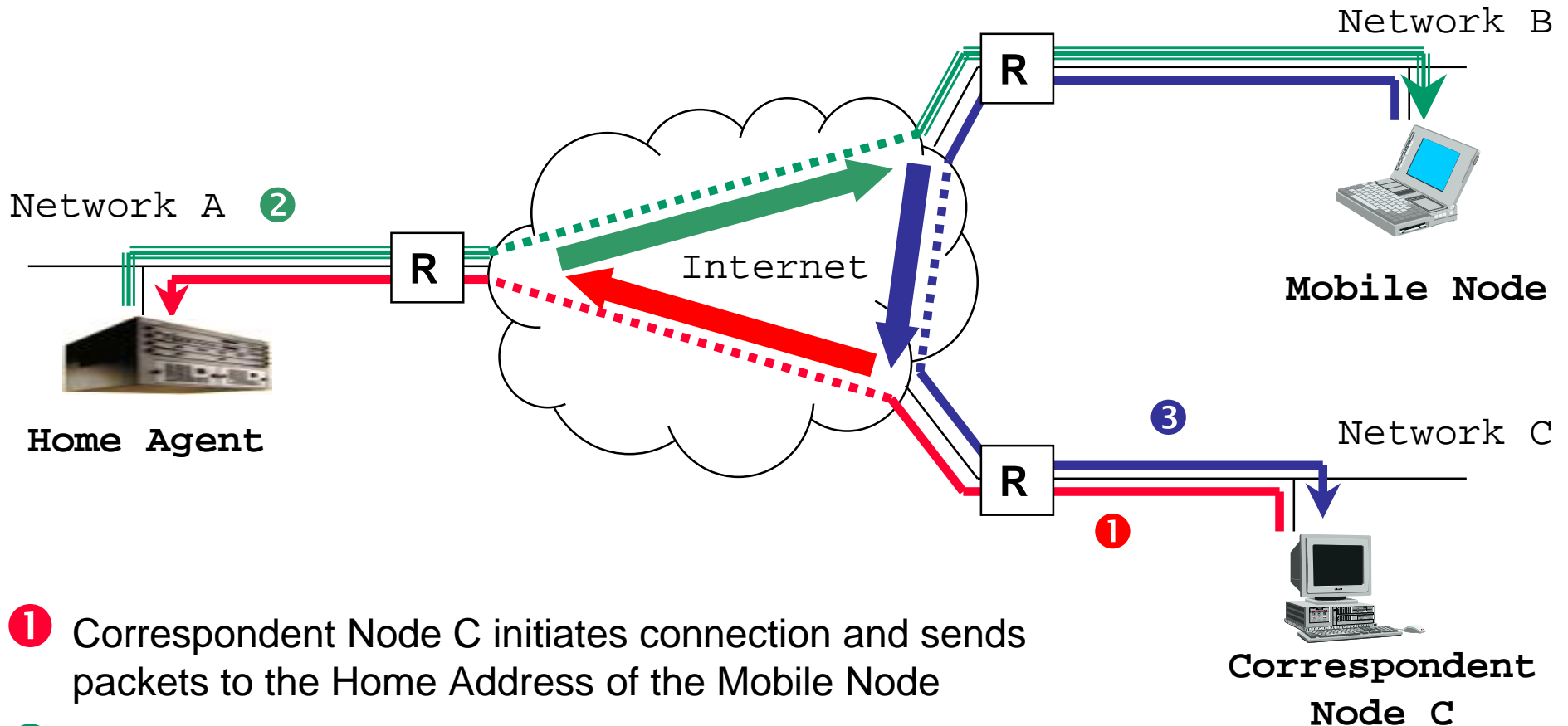

- 1 Correspondent Node C initiates connection and sends packets to the Home Address of the Mobile Node
- 2 Home Agent intercepts packets and tunnels them to the Mobile Node
- 3 Mobile Node sends answer directly to Host C



Normal Operation by Route Optimization

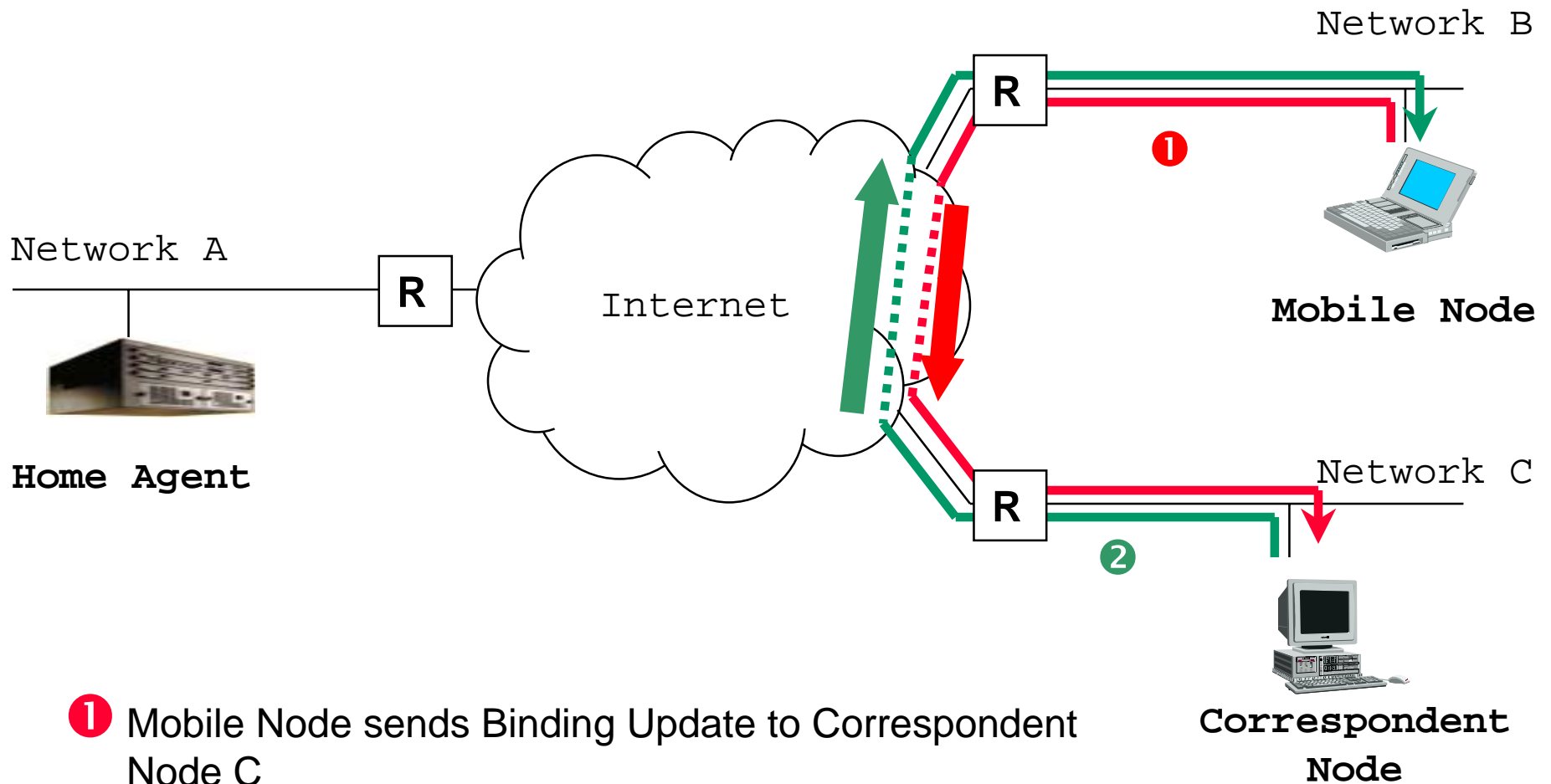

- 1 Mobile Node sends Binding Update to Correspondent Node C
- 2 Now Correspondent Node can address the CoA of the Mobile Node directly



Mobile IPv6 Roaming

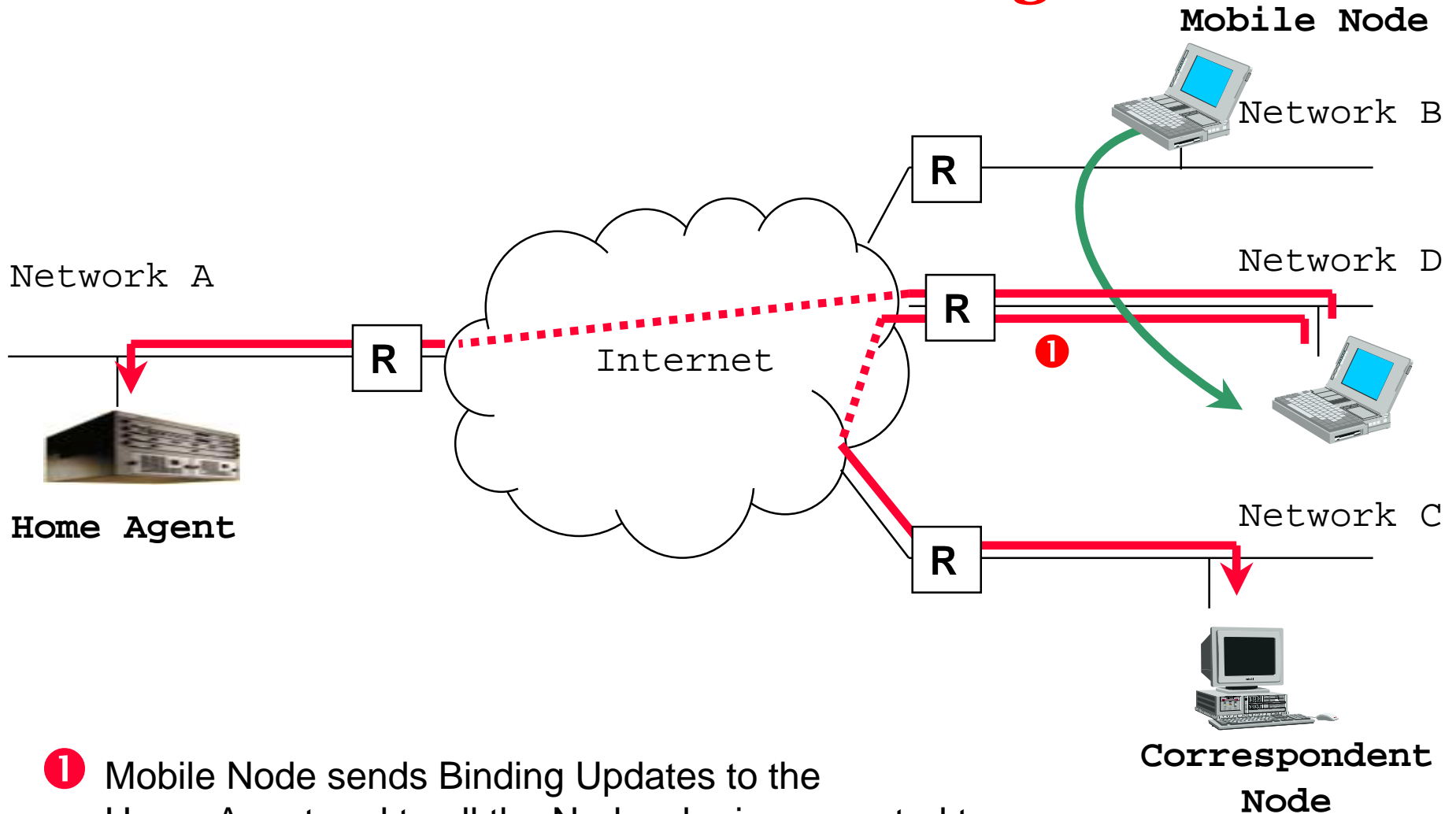

- 1 Mobile Node sends Binding Updates to the Home Agent and to all the Nodes, he is connected to



Movement Detection

Scenario-I : Mobile node to know quickly when the when the Default router will be unavailable

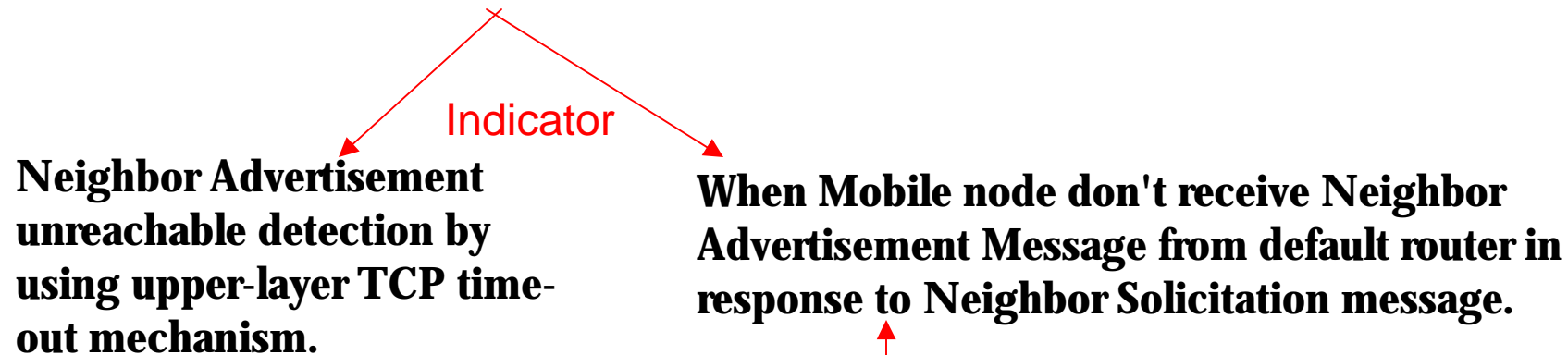

Scenario II : When Mobile node become unreachable to default Router



Renumbering Home Subnet

When Home subnet change its internet service from different ISP then its Network Prefix changes (thereby Network Prefix of all nodes on Home Subnet also changes)

Nodes on the Home Subnet update their Network Prefix, via Neighbor Discovery mechanism.

Node which is away from Home Subnet need Special Care.

Home Agent tunnel Authenticated Router Advertisement to each Mobile node it serve.

Mobile node performs standard autoconfiguration mechanism to create new Home Address.

When Mobile node return home, it first performs duplicate address detection.

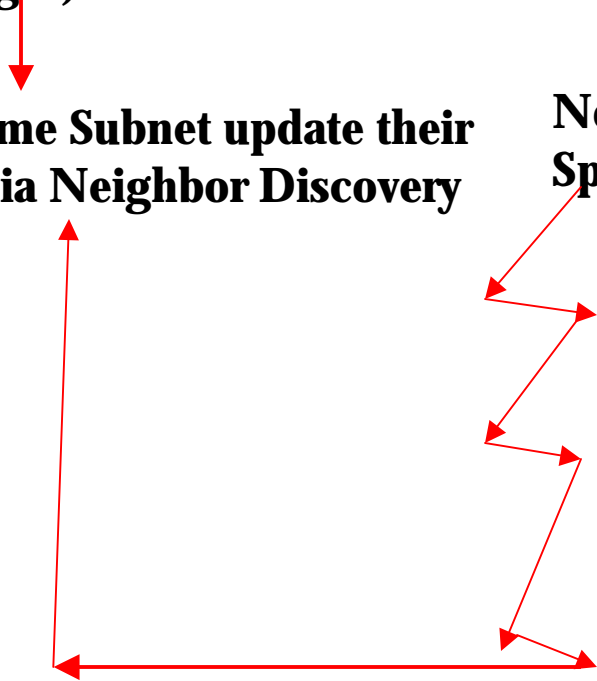

Home Subnet Change

Home Agent Send
Encapsulated Network
Prefix to each Mobile
Node Which is registered
with it.

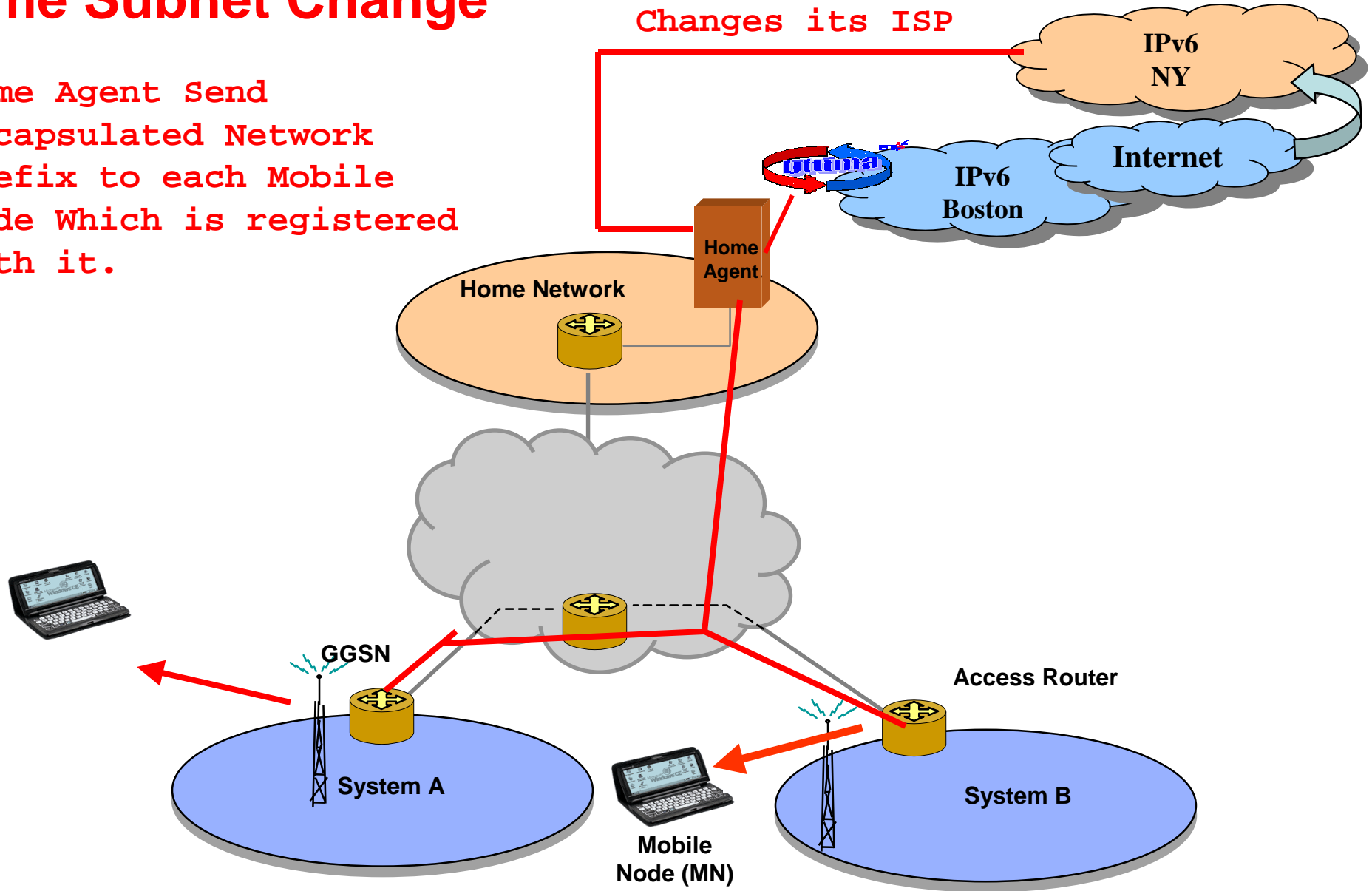

Home Subnet Change

HA Goes Down for Some Reason

Home Agent 2 start
Sending Encapsulated
Network Prefix to each
Mobile Node Which was
registered Home Agent 1.

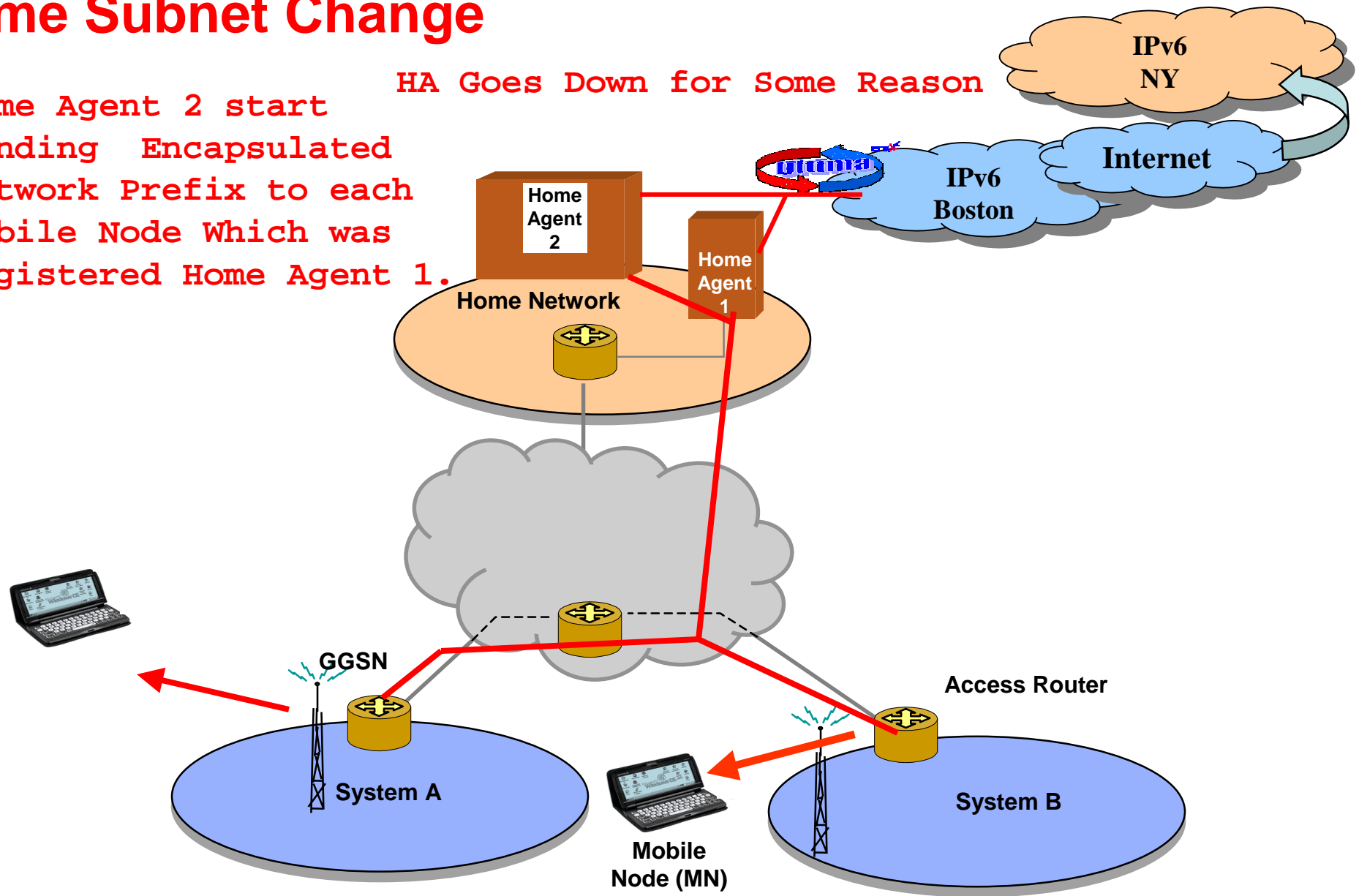

Dynamic Home Agent Address Discovery (Renumbering)

Home Agents List	Priority
Home Agent 3	9
Home Agent 1	2
Home Agent 2	-3

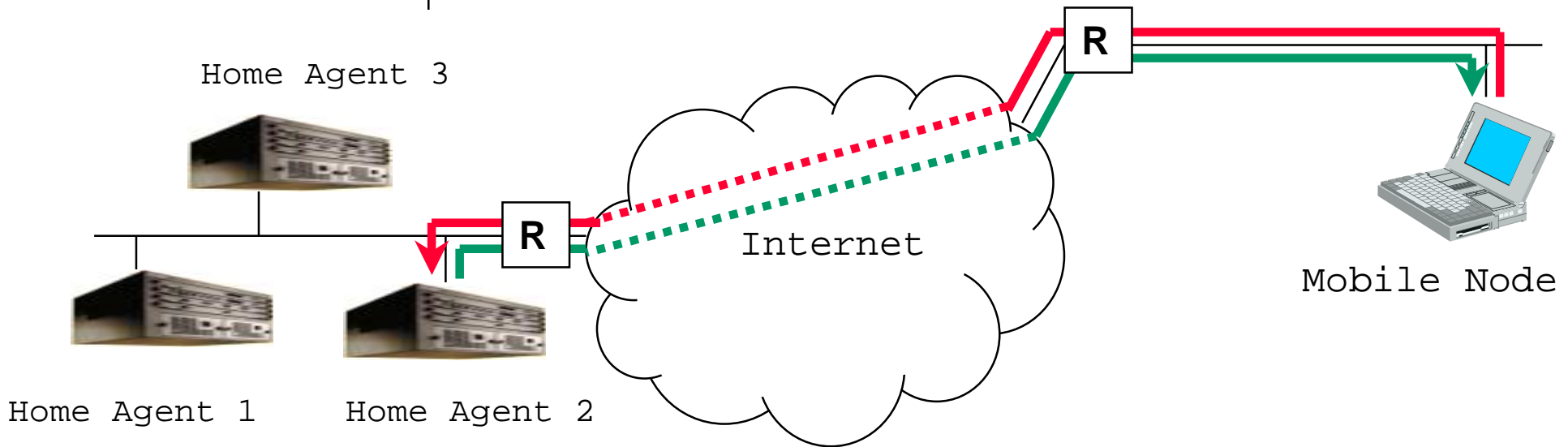

- 1 Mobile Node sends Binding Update to the Home Agents Anycast Address of its home network
- 2 One Home Agent answers with Binding Acknowledgement containing a list of available Home Agents



Registration at selected Home Agent

Home Agents List	Priority
Home Agent 3	9
Home Agent 1	2
Home Agent 2	-3

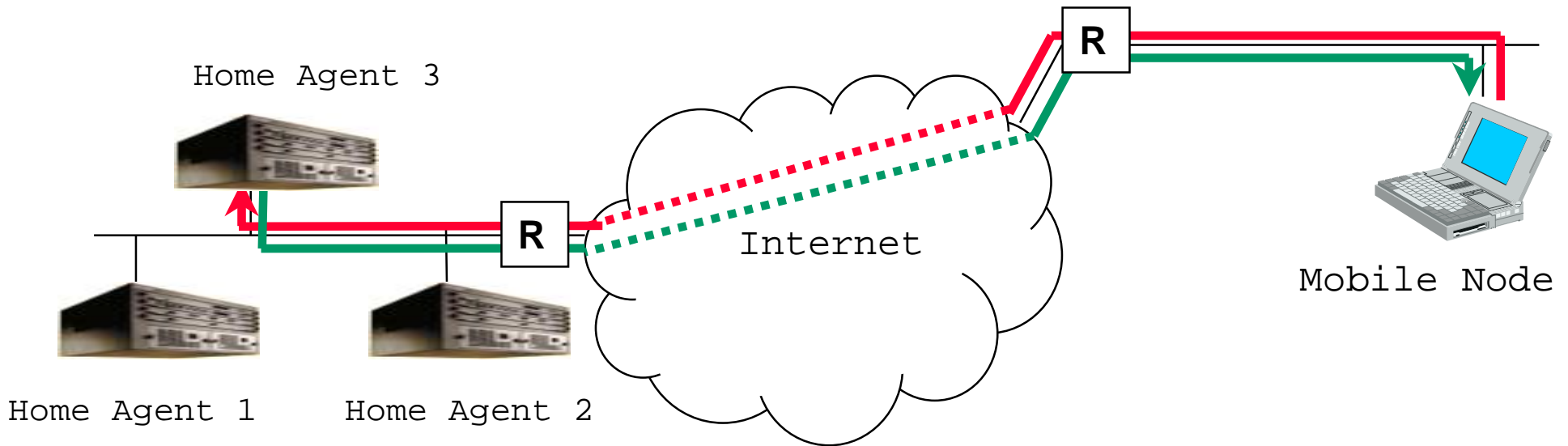

- 1 Mobile Node sends Binding Update to the first Home Agent contained in the Home Agents List
- 2 Binding Acknowledgement completes Registration process



ICMP Role

When an IPv6 node discards a packet, it sends an error message to the source.

There are four types of message:

1. **Destination unreachable (type=1).** Sent by a router to the source when a packet cannot be forwarded to its destination.
2. **Packet too big (type =2).** Used when the link MTU on the forwarding link is smaller than the packet.
3. **Time exceeded (type=3).** Indicates that the packet's hop limit field is zero.
4. **Parameter problem (type=4).** Indicates that a field of the datagram is not recognized as valid and the packet can thus not be processed.

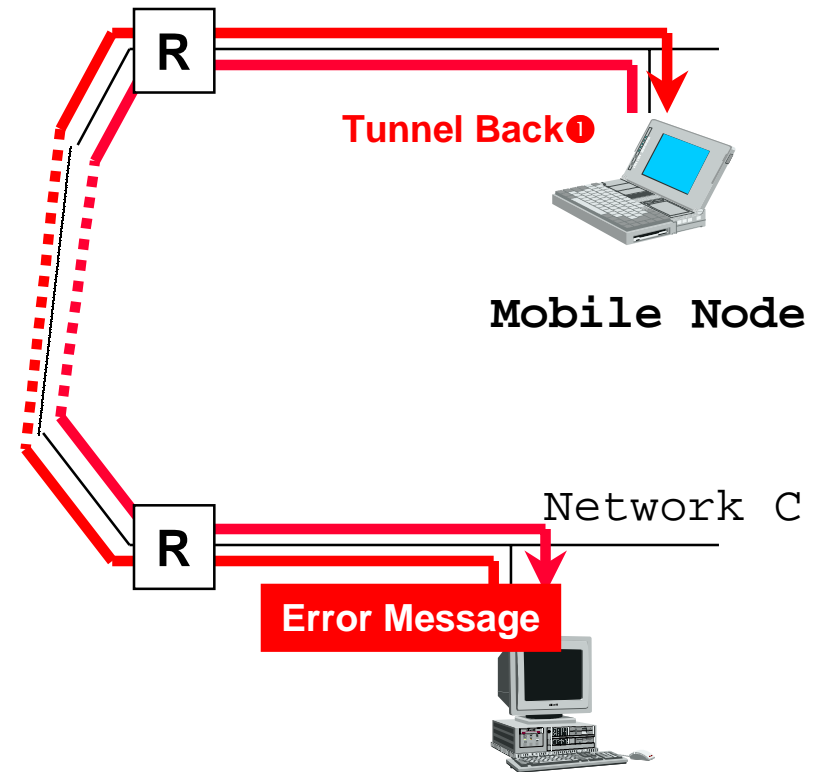

ICMP: Includes the so-called Neighbor Discovery mechanisms, the terminal autoconfiguration mechanisms and address resolution mechanisms.



Handling ICMP Scenario 2

When CoN send error message through Home Agent.

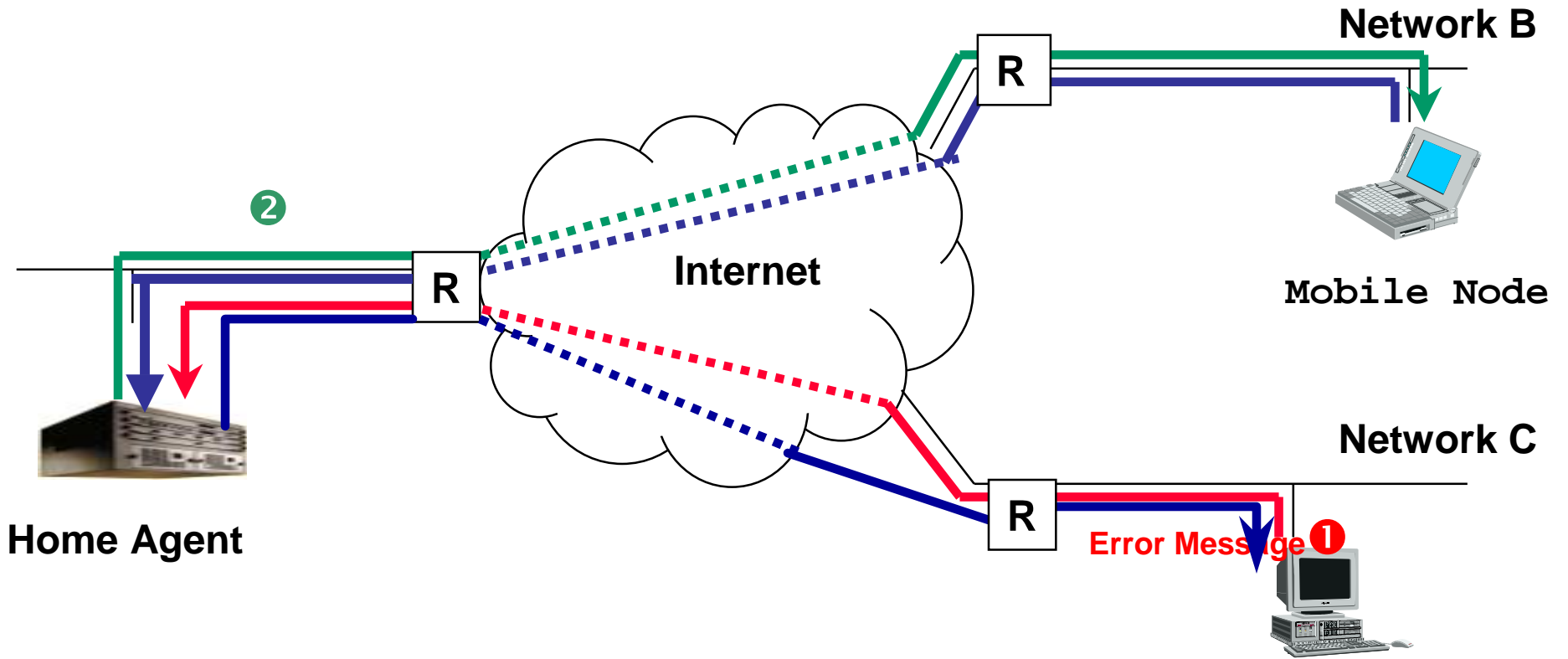

Smooth/Fast/Seamless Handover

- **Smooth handover == low loss**
- **Fast handover == low delay**
 - 30 ms?
 - Duplicate Address Detection?? (can router pre-empt this?)
- **Seamless handover == *smooth* and *fast***

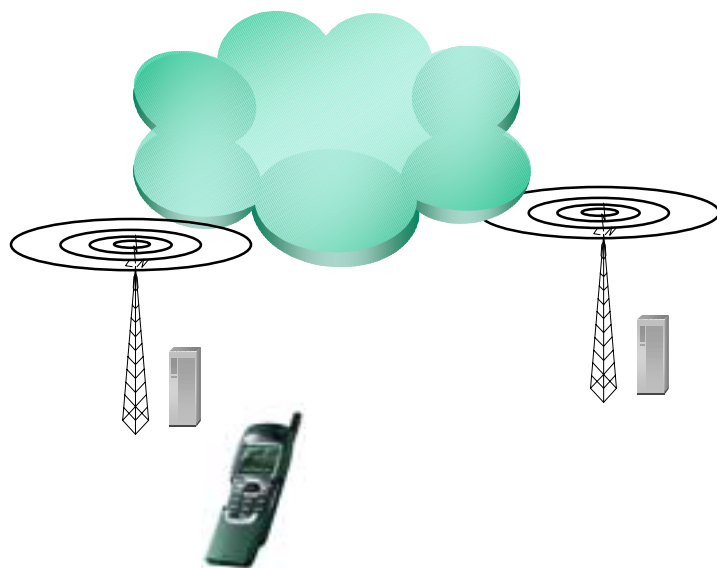

Mobile-controlled seamless handover

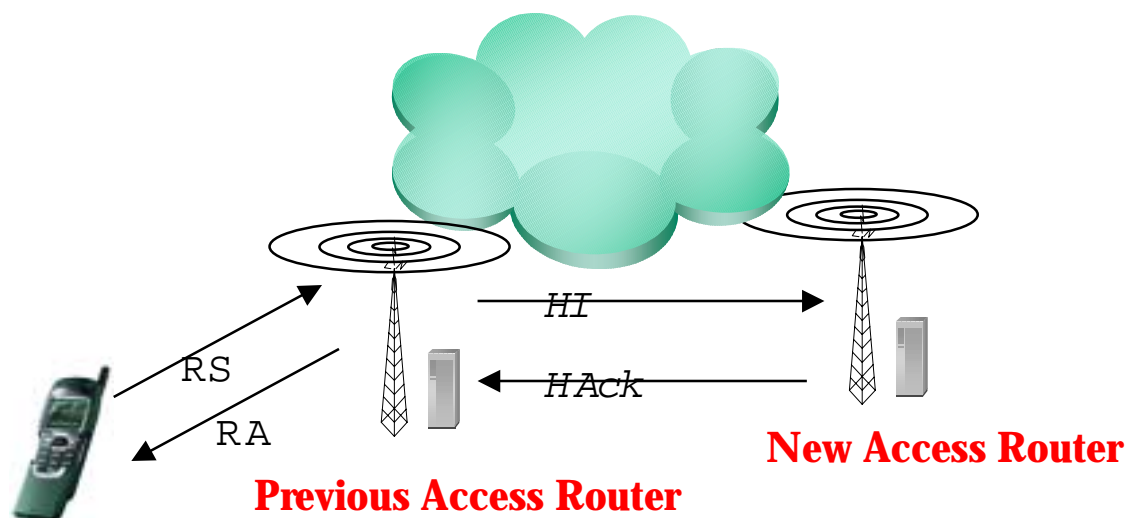

One scenario: mobile sends special Router Solicitation (RS)

- **Previous Access Router replies with *Proxy Router Advert.* (RA)**
- **Previous Access Router sends Handover Initiate (HI)**
- **New Access Router sends Handover Acknowledge (HACK)**



Network Controlled Handover

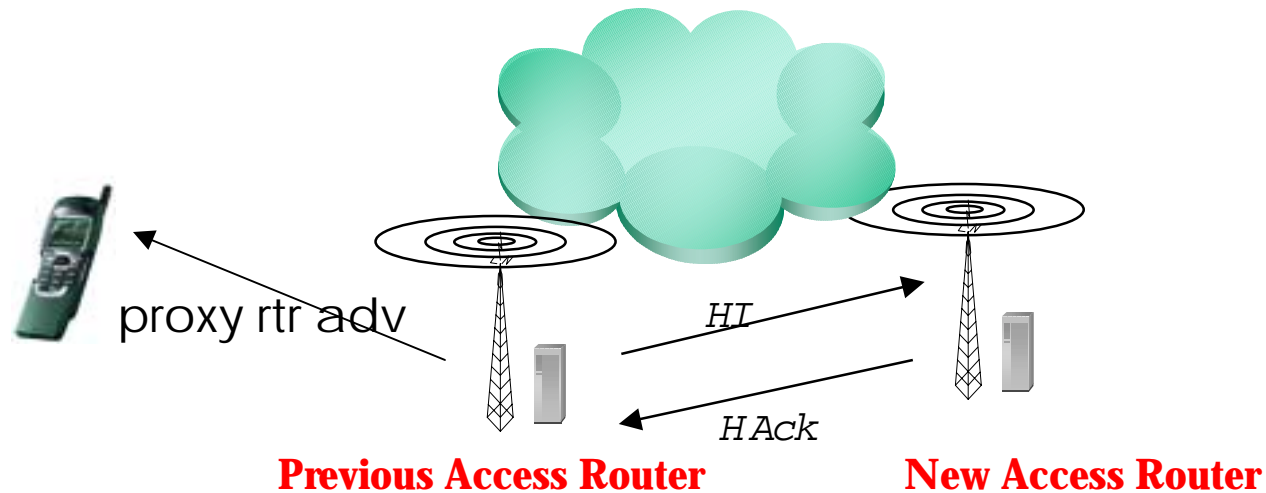

- **Previous access router sends Proxy Router Advertisement on behalf of the new access router – contains prefix and lifetime information, etc.**
- **Previous access router sends *Handover Initiate* message to new access router**
- **Mobile node *MAY* finalize context transfer at new access router**



Ongoing Work for Open Questions

Security issues: Firewalls, cause difficulty for Mobile IP because they block all classes of incoming packets that do not meet specified criteria.



Gupta and Glass have proposed a firewall traversal extend Mobile IP operation across firewalls, even when multiple security domains are involved.

Ingress filtering: Many border routers discard packets if the packets do not contain a source IP address configured for one of the enterprise's internal networks



Montenegro has proposed the use of reverse tunnels to the home agent to counter the restriction imposed by ingress filtering.

Deficiency of Mobile IPv6, is that it does not support fast handoff – (this is the ability to switch to another subnet without significant delay or loss of packets). Excessive signalling in rapidly changing cells.



Extension to Mobile IPv6 called “**HIERARCHICAL MOBILE IP v6**”.



Hierarchical Mobile IPv6

Hierarchy

- Extension to Mobile IPv6
- Introduces hierarchical registration scheme

Scalability

- Not always registration to Home Agent necessary

Handoff

- Local registration decreases Handoff delay

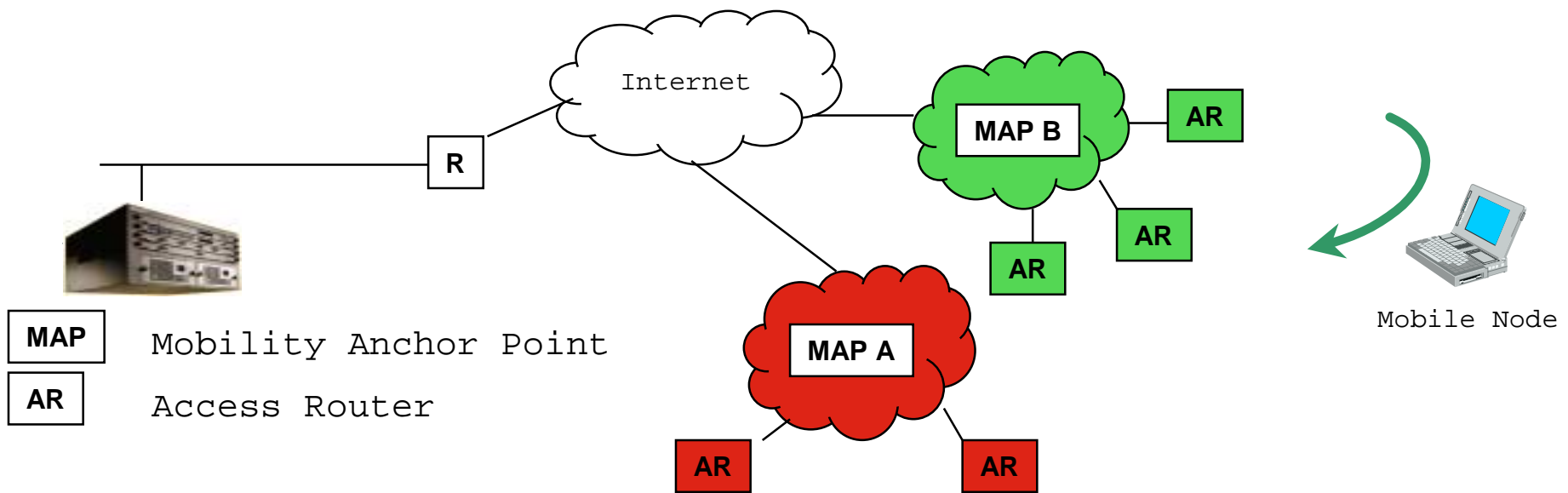

Example 1: Mobility within Domain

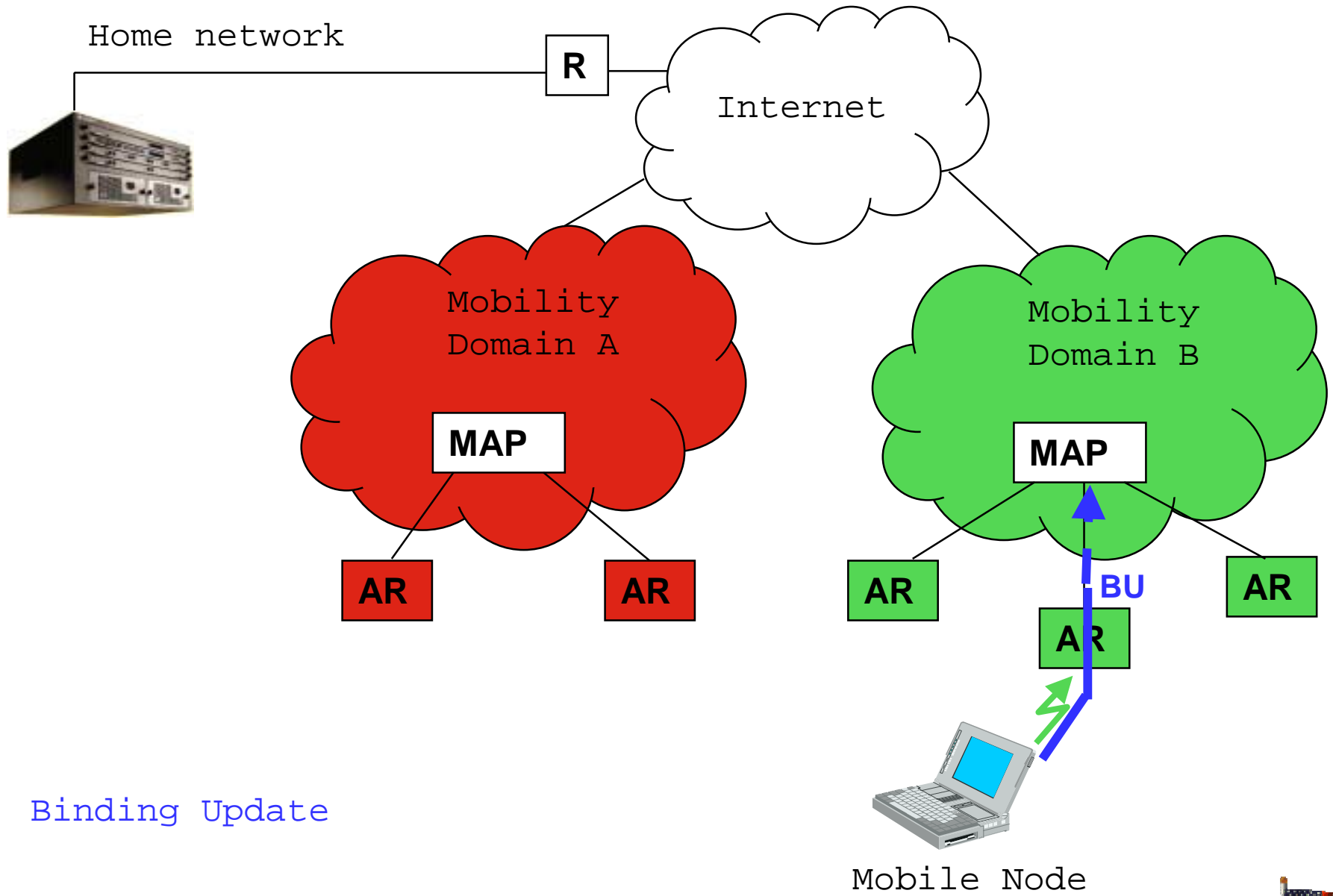

BU Binding Update



Example 2: Mobility between Domains

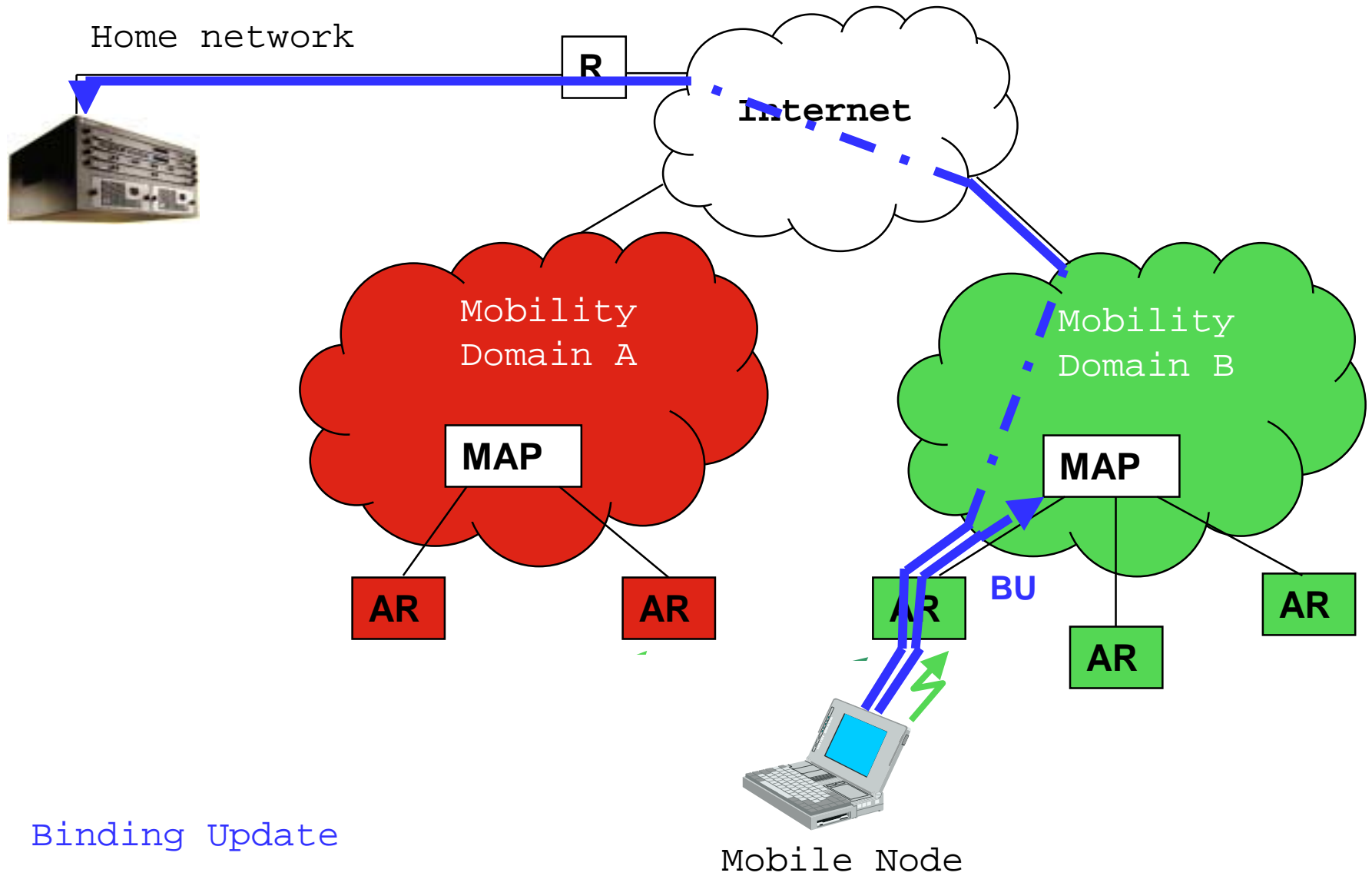

BU Binding Update

Mobile Node

52



Summary

Both “sides”, Internet and Cellular Communication, have recognized the promising potential of the Mobile Internet market

Co-operation between organizations of the Internet and Cellular Communication side are established

IPv6 and Mobile IPv6 are seen as an efficient and scalable solution for the future Mobile Internet

Numerous research activities take place in the area of IPv6 for mobile users

From the technical side not all problems are solved now - but we are doing a good job here



Diversity of today's available mobile devices



Q

&

A



Thanks
for your attention!

