

# LANs

Studying  
Local Area Networks  
via the  
Media Access Control (MAC)  
SubLayer

# Local Area Networks

- Aloha
- Slotted Aloha
- CSMA (non-persistent, 1-persistent, p-persistent)
- CSMA/CD
- Ethernet
- Token Ring

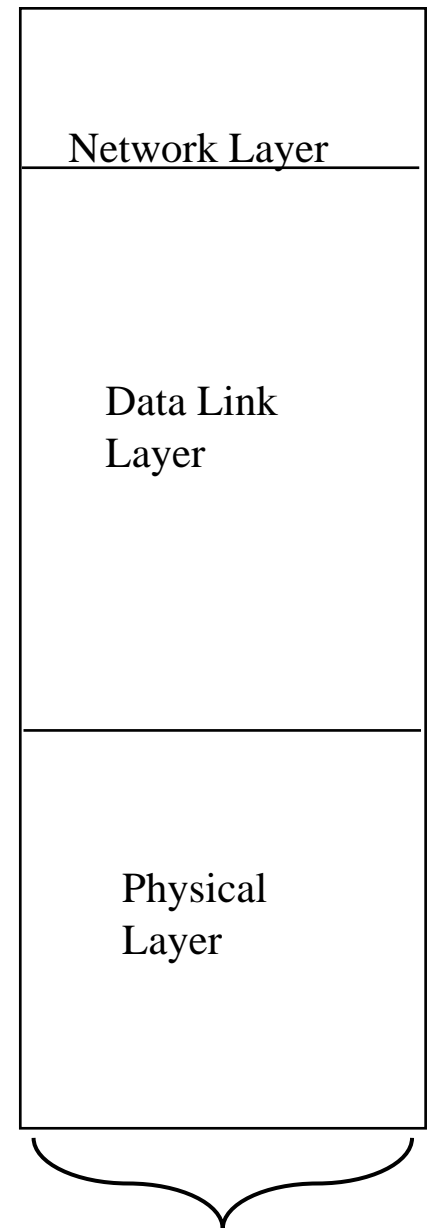
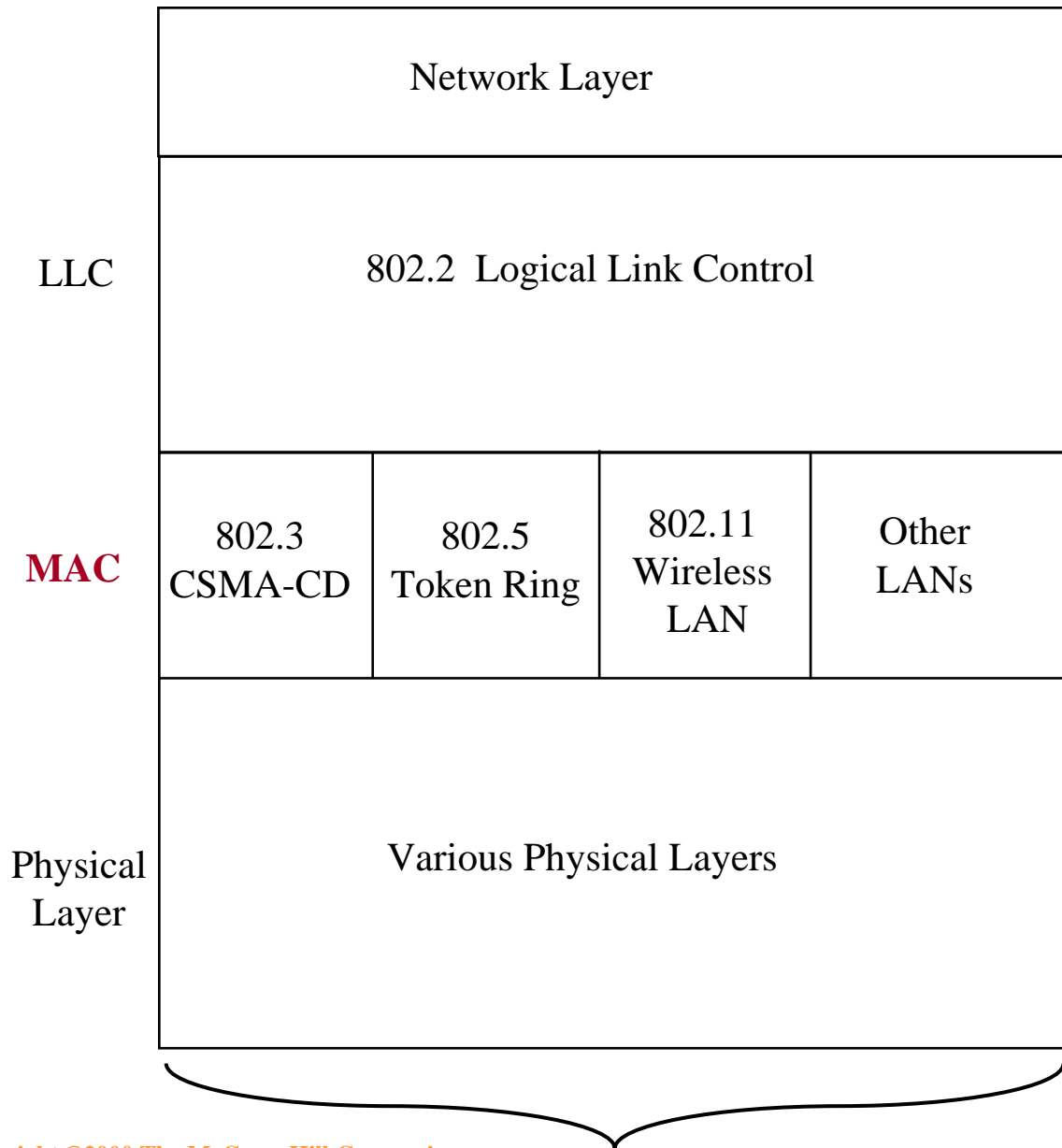

Copyright ©2000 The McGraw Hill Companies

IEEE 802

OSI

Figure 6.11



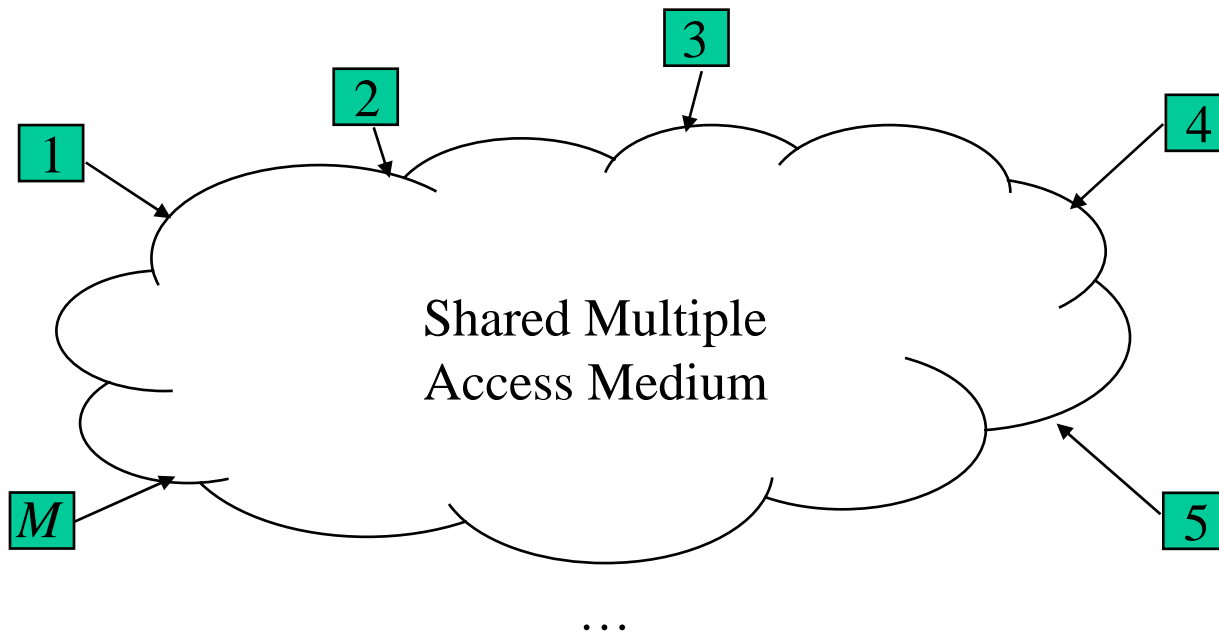

# Static Channel Allocation Problem

The history of broadcast networks includes satellite and packet radio networks.

Let us view a **satellite** as a **repeater** amplifying and rebroadcasting everything that comes in.

To generalize this problem, consider networks where every frame sent is *automatically* received by every site (node).

# Satellite Channel

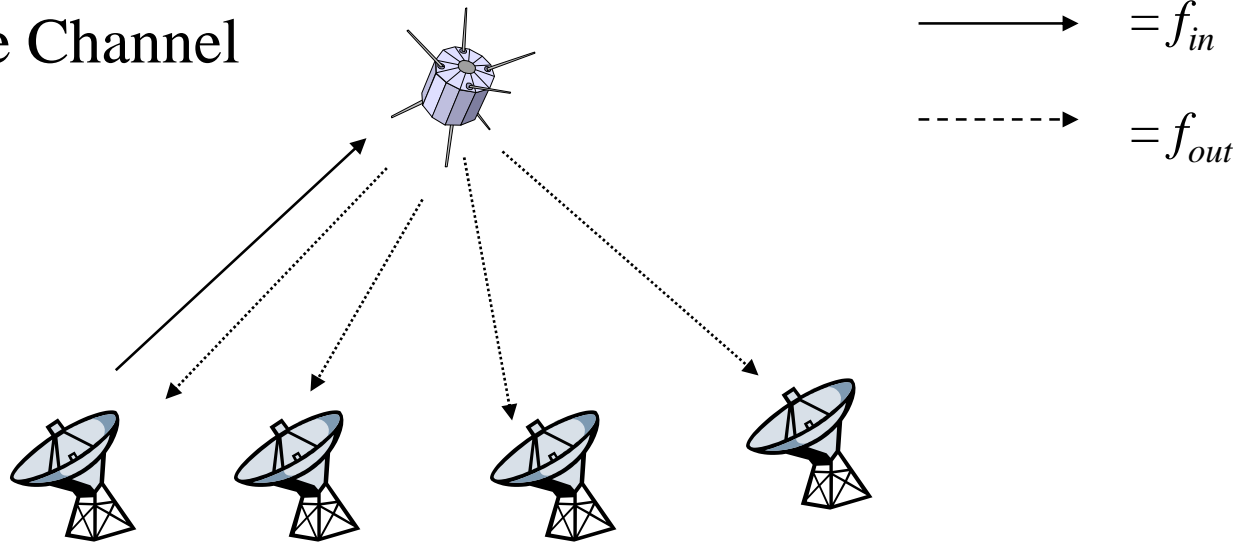

# Static Channel Allocation Problem

We model this situation as  $n$  independent users (one per node), each wanting to communicate with another user and they have no other form of communication.

## The Channel Allocation Problem

To manage a single broadcast channel which must be shared *efficiently* and *fairly* among  $n$  uncoordinated users.

### Ring networks

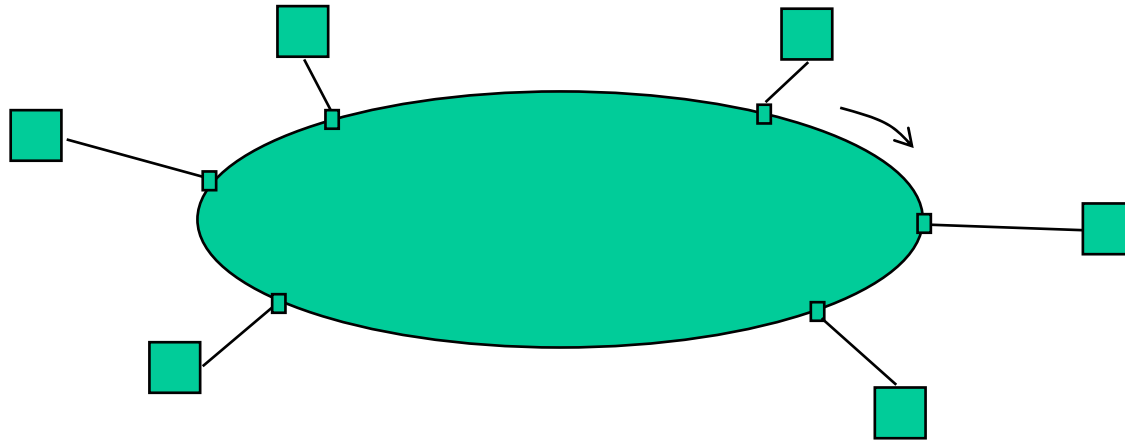

### Multitapped Bus

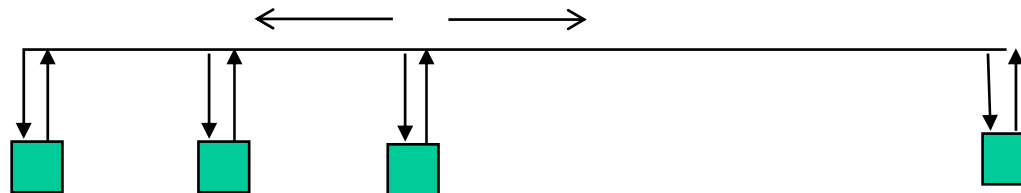



# Possible Model Assumptions for the Channel Allocation Problem

0. *Listen property* :: (applies to satellites)

The sender is able to *listen* to sent frame one round-trip after sending it.

→ no need for explicit ACKs.

1. The model consists of  $n$  *independent stations*.

2. A single channel is available for communications.

# Possible Model Assumptions for the Channel Allocation Problem

3. *Collision Assumption* :: If two frames are transmitted **simultaneously**, they overlap in time and the resulting signal is garbled. *This event is a **collision**.*
- 4a. *Continuous Time Assumption* :: frame transmissions can begin at any time instant.
- 4b. *Slotted Time Assumption* :: time is divided into discrete intervals (**slots**). Frame transmissions always begin at the start of a time slot.

# Possible Model Assumptions for the Channel Allocation Problem

## 5a. *Carrier Sense Assumption (CS)::*

Stations can tell if the channel is busy (in use) before trying to use it. If the channel is busy, no station will attempt to use the channel until it is idle.

## 5b. *No Carrier Sense Assumption ::*

Stations are unable to sense channel before attempting to send a frame. They just go ahead and transmit a frame.

# *a :: Relative Propagation Time*

$$a = \frac{\text{length of the data path (in bits)}}{\text{length of a standard frame (in bits)}}$$

-OR-

$$a = \frac{\text{propagation time ( in seconds)}}{\text{transmission time (in seconds)}}$$

-OR-

$$a = \frac{\text{delay-bandwidth product}^*}{\text{average frame size}} \quad [\text{LG\&W def p.346}]$$

*\* Delay-bandwidth product :: the product of the capacity (bit rate) and the delay.*

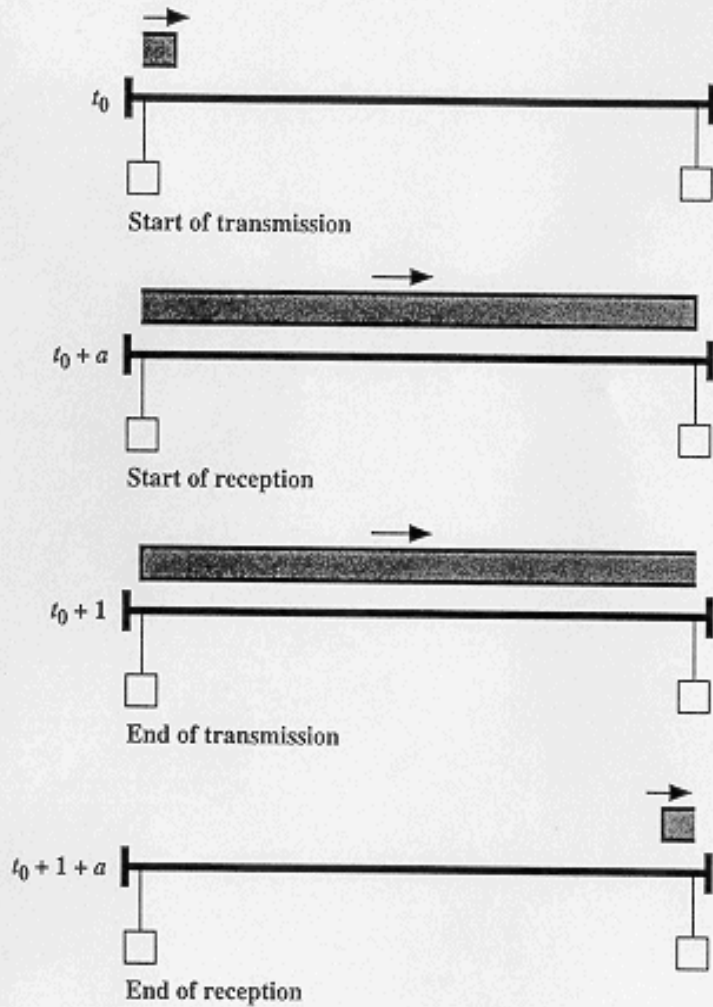

(a) Transmission time = 1; propagation time =  $a < 1$

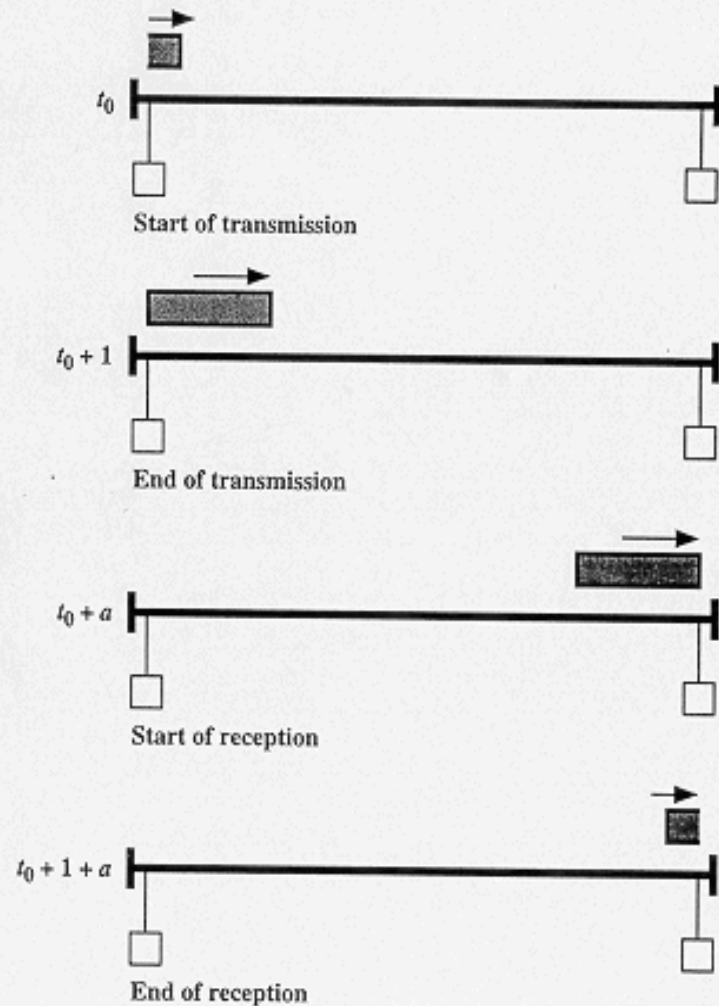

(b) Transmission time = 1; propagation time =  $a > 1$

Figure 15.2 The Effect of  $a$  on Utilization for Baseband Bus

# Relative Propagation Time

**R** = capacity (data rate)

**d** = maximum distance of communications path

**v** = propagation velocity (Assume  $v = 2/3$  speed of light  $2 \times 10^8$  meters/second)

**L** = frame length

$$a = \frac{d / v}{L/R} = \frac{Rd}{vL}$$

# Upper Bound on Utilization for Shared Media LAN

Assume a perfect, efficient access that allows one transmission at a time where there are no collisions, no retransmissions, no delays between transmissions and no bits wasted on overhead.  
*{These are best-case assumptions}*

$$Util = \frac{T_{put}}{Capacity} = \frac{L}{\text{propagation time} + \text{transmission time}}$$
$$R$$

# Maximum Utilization for LANs

$$\text{max. Util} = \frac{\frac{L}{d} + \frac{L}{R}}{\frac{L}{Rd} + \frac{L}{v} + 1} = \frac{1}{a + 1}$$

$$\text{max. Util} = \frac{1}{1 + a}$$



# Worst-case Bus Collision Scenario

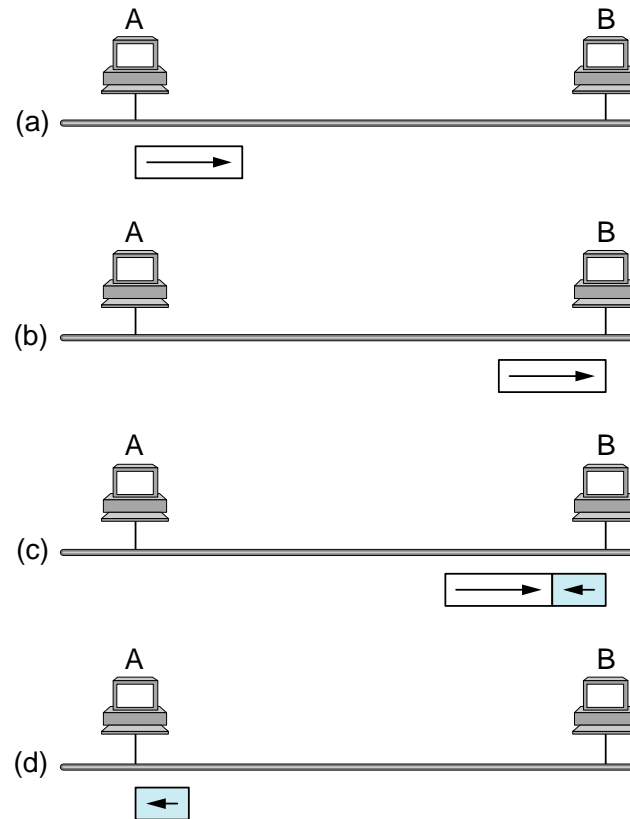
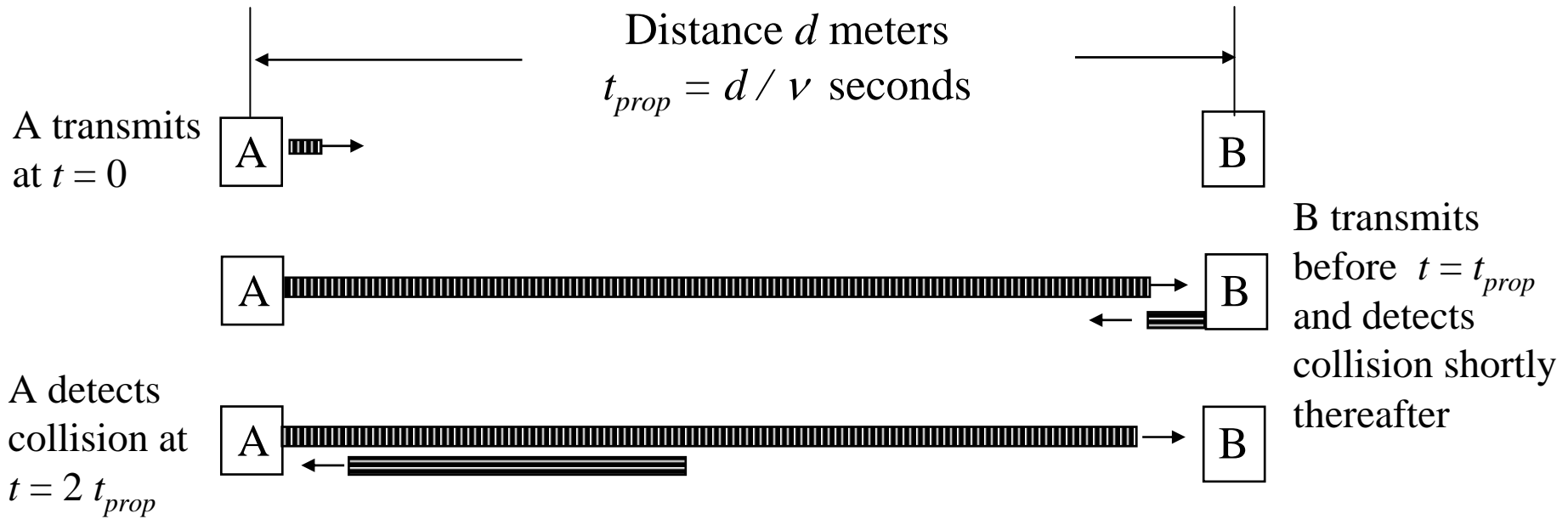

Figure 2.28 B's collided frame arrives at  $t+2d$

*P&D slide*



# LAN Design Performance

*For broadcast LANs what are the factors under the designer's control that affect LAN performance?*

- Capacity *{function of media}*
- Propagation delay *{function of media, distance}*
- Bits /frame (frame size)
- MAC protocol
- Offered load – depends on how retransmissions are handled
- Number of stations
- Bit error rate

# Typical frame delay versus throughput performance

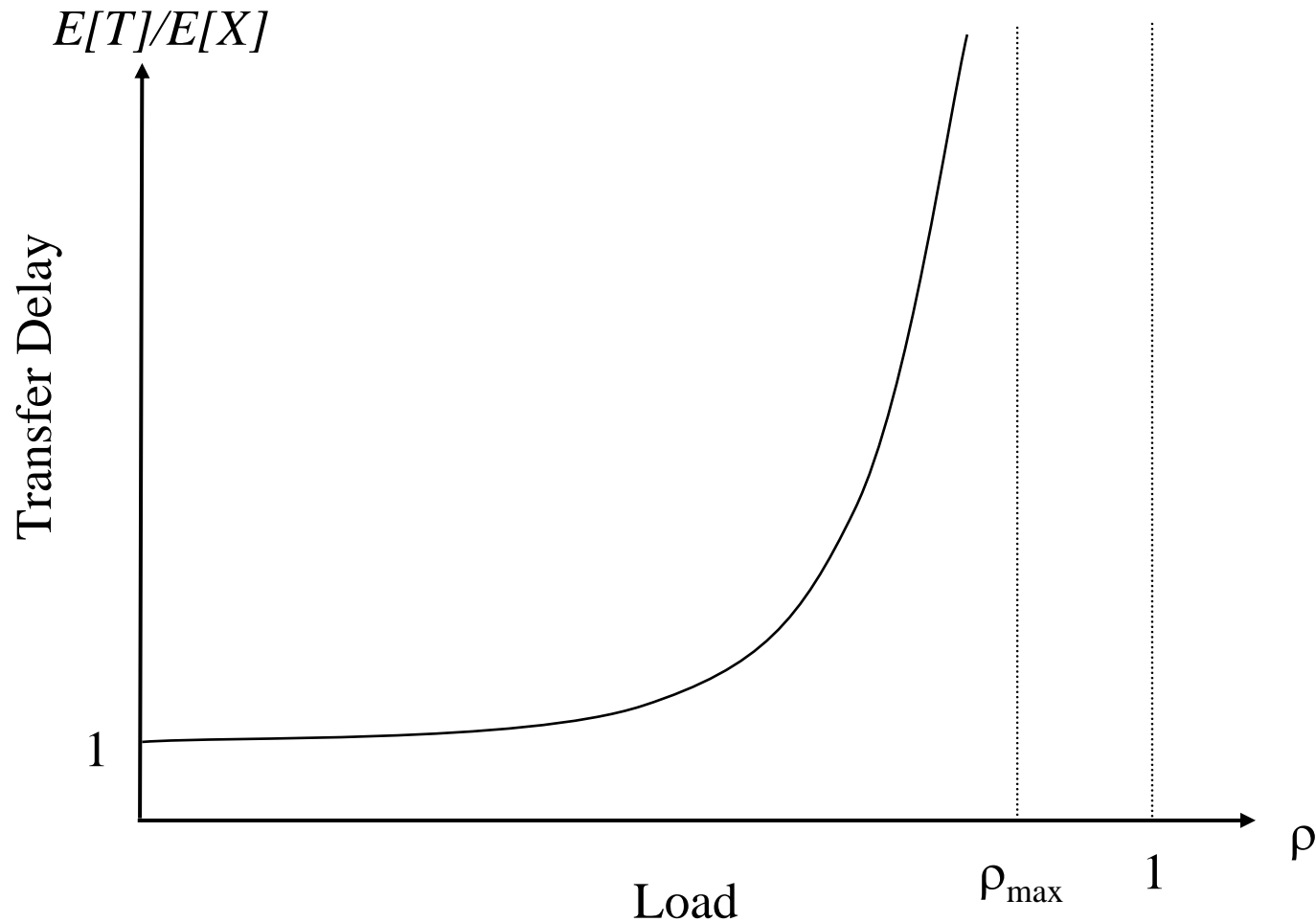

# Delay-Throughput Performance Dependence on $a$

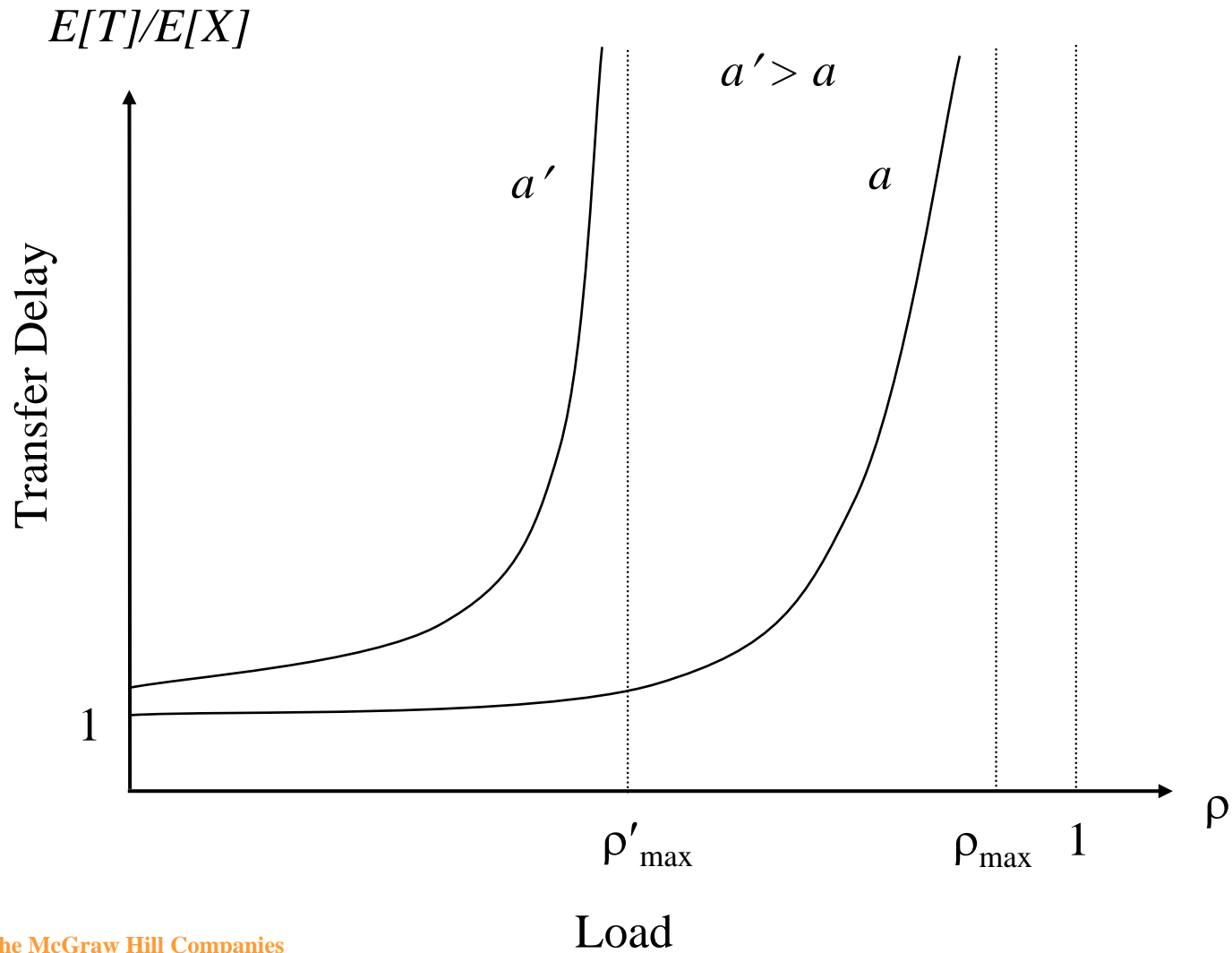

Copyright ©2000 The McGraw Hill Companies

Leon-Garcia & Widjaja: *Communication Networks*

Figure 6.9

Computer Networks: Local Area Networks



# Multiple Access Protocols

# Historic LAN Performance Notation

**I** :: input load - the total (normalized) rate of data generated by all **n** stations

**G** :: offered load – the total (normalized) data rate presented to the network *including retransmissions*

**S** :: throughput of LAN - the total (normalized) data rate transferred between stations

**D** :: average frame delay – the time from when a frame is ready for transmission until completion of a successful transmission.

# Normalizing Throughput (S)

*[assuming one packet = one frame]*

*Throughput (S)* is normalized using packets/packet time where

**packet time** :: the time to transmit a *standard* fixed-length packet

i.e.,

$$\text{packet time} = \frac{\text{packet length}}{\text{bit rate}}$$

NOTE: Since the channel capacity is one packet /packet time, S can be viewed as *throughput as a fraction of capacity*.

Represented in LG&W by  $\rho$  in later graphs.



# Historic LAN Performance Notation

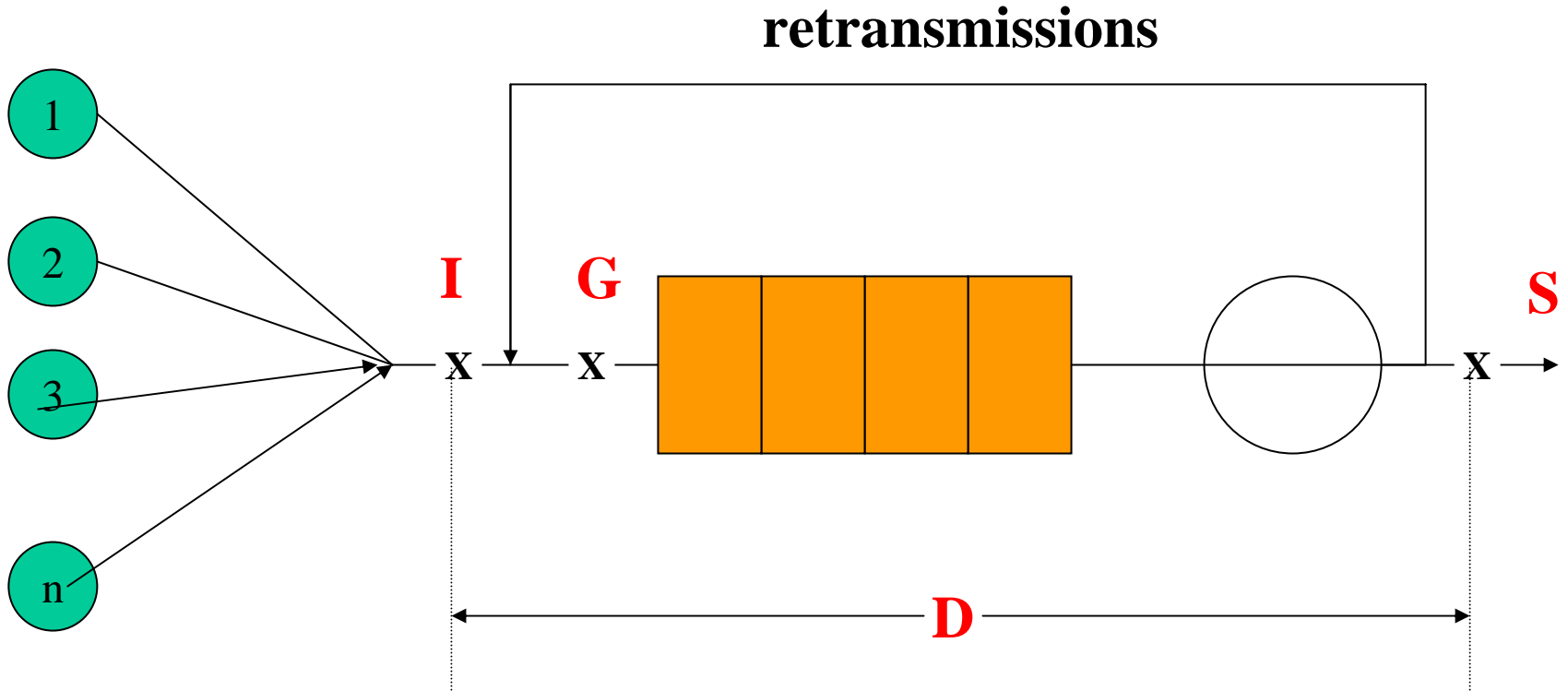

# ALOHA

- Abramson solved the channel allocation problem for ground radio at University of Hawaii in 1970's.

## Aloha Transmission Strategy

**Stations transmit whenever they have data to send.**

- **Collisions** will occur and colliding frames are destroyed.

## Aloha Retransmission Strategy

**Station waits a *random amount of time* before sending again.**

# Pure ALOHA

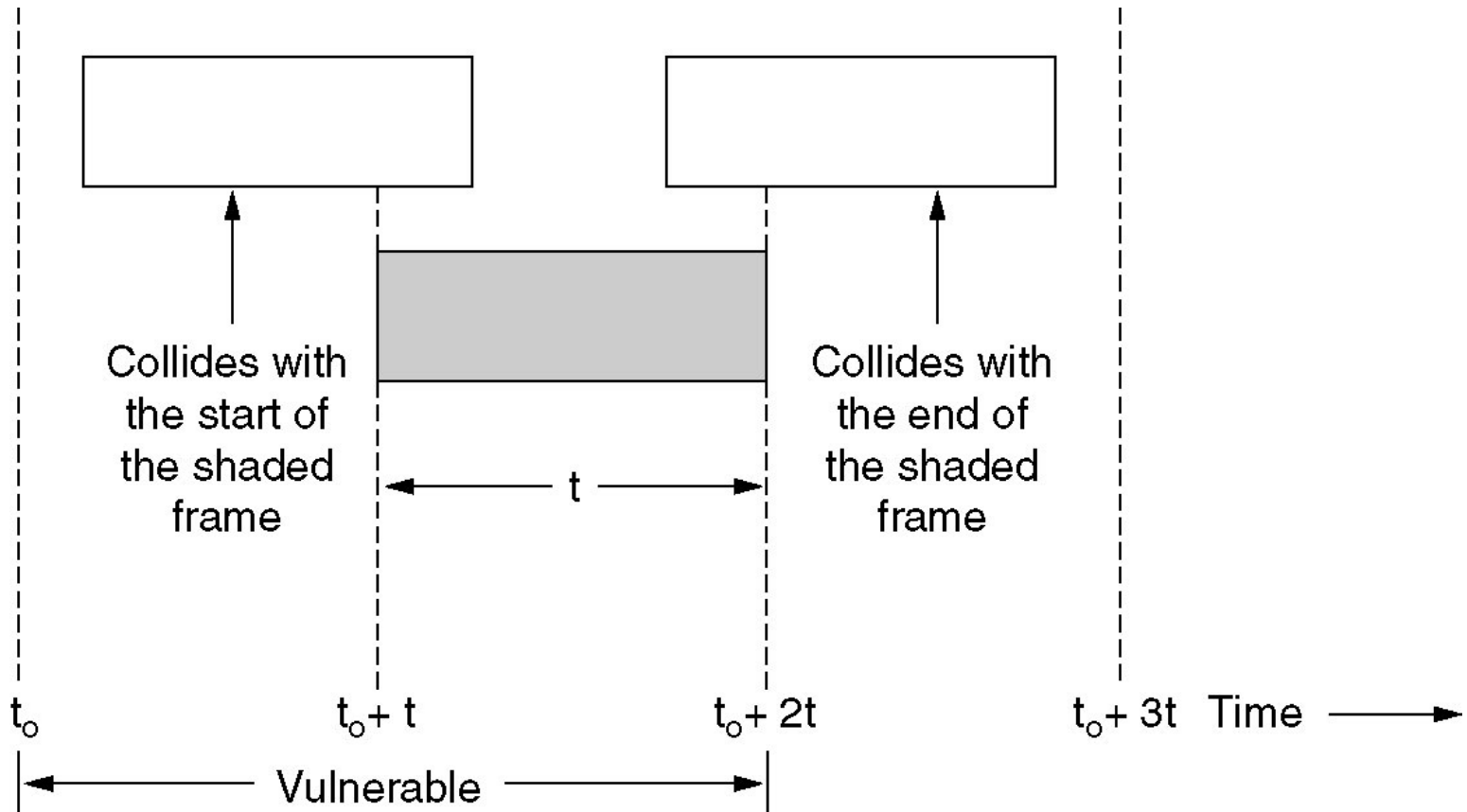
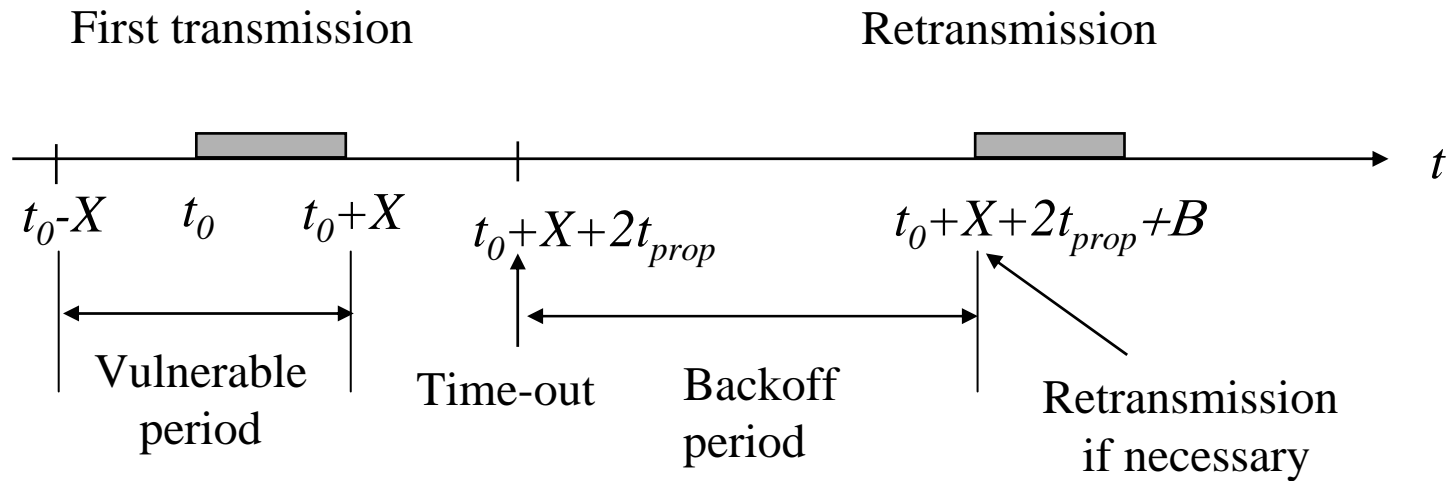

Figure 4-2. Vulnerable period for the shaded frame.

*Tanenbaum slide*

# ALOHA



**random backoff period  $B$**

# ALOHA

**Vulnerable period ::  $t_0 - X$  to  $t_0 + X$  two frame transmission times**  
**Assume: Poisson Arrivals with average number of arrivals of  $2G$  arrivals/  $2X$**

$$S = G e^{-2(1+a)G}$$

# Slotted ALOHA (Roberts 1972)

- uses discrete time intervals as *slots (i.e., slot = one packet transmission time)* and synchronize the send time (e.g., use “pip” from a satellite).

## Slotted Aloha Strategy

Station transmits **ONLY** at the beginning of a time slot.

- **Collisions** will occur and colliding frames are destroyed.

## Slotted Aloha Retransmission Strategy

Station waits a *random amount of time* before sending again.

# Slotted ALOHA

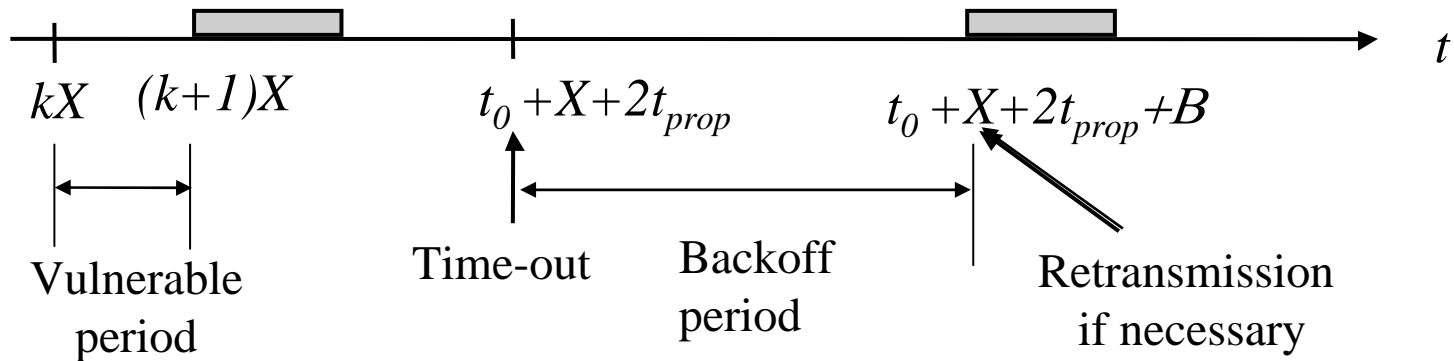

**random backoff period  $B$  slots**

# Slotted ALOHA

Vulnerable period ::  $t_0 - X$  to  $t_0$  **one frame transmission time**

Assume: Poisson Arrivals with average number of arrivals of  $G$  arrivals/  $X$

$$P_0 = P[k=0, t=1] = e^{-G}$$

$$S = G P_0$$

$$S = G e^{-G}$$

and an adjustment for  $a$  yields

$$S = G e^{-(1+a)G}$$



# ALOHA and Slotted ALOHA Throughput versus Load

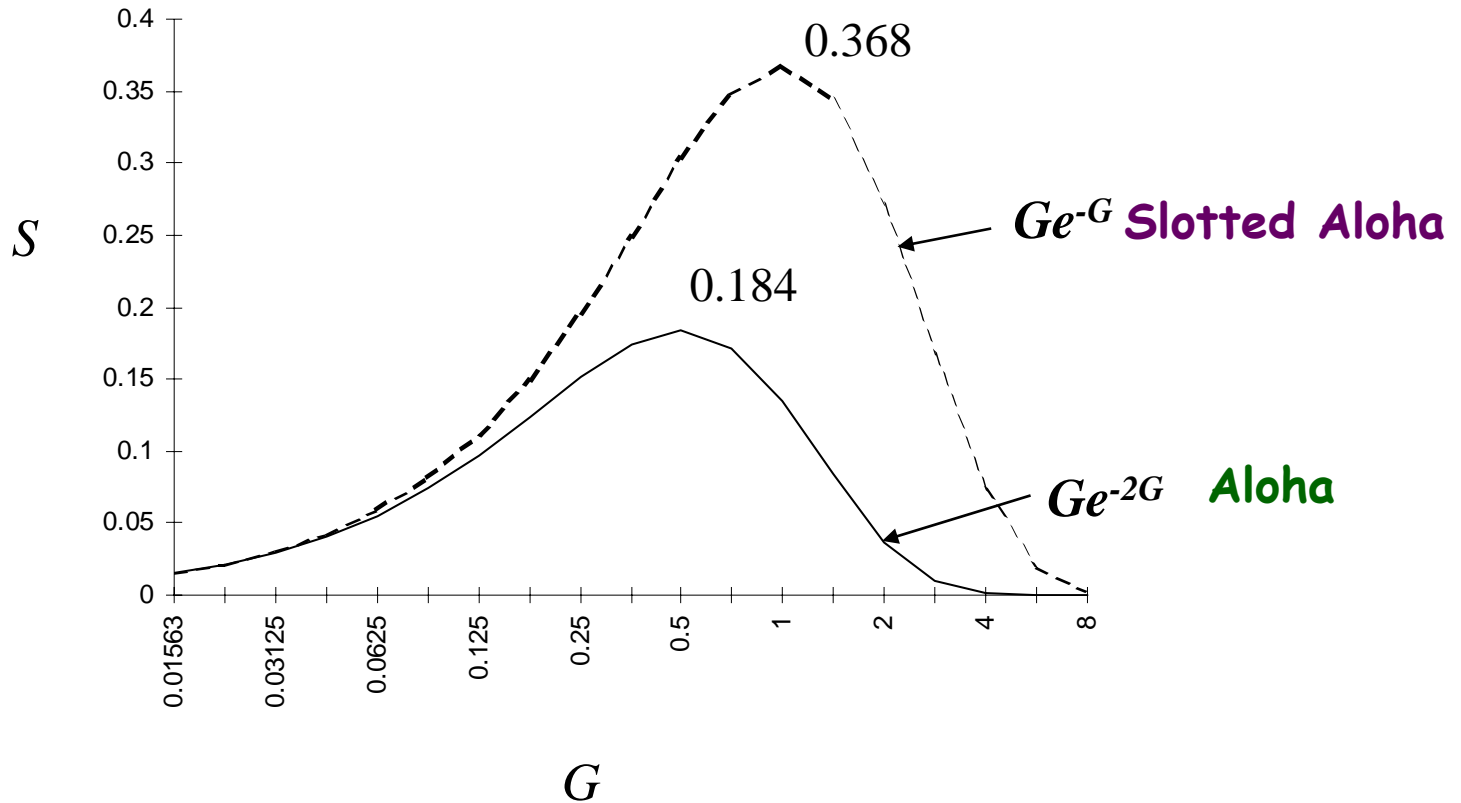

# Carrier Sense with Multiple Access (CSMA)

## 1-persistent CSMA Transmission Strategy

*"the greedy algorithm"*

1. Sense the channel.
2. IF the channel is *idle*, THEN transmit.
3. IF the channel is *busy*, THEN continue to listen until channel is *idle* and transmit immediately.

# nonpersistent CSMA Transmission Strategy

*"the less-greedy algorithm"*

- Sense the channel.
- IF the channel is *idle*, THEN transmit.
- 1. IF the channel is *busy*, THEN wait a random amount of time and repeat the algorithm.

# $p$ - persistent CSMA Transmission Strategy

*"a slotted approximation"*

1. Sense the channel.
2. IF the channel is *idle*, THEN with probability  $p$  transmit and with probability  $(1-p)$  delay *one time slot* and repeat the algorithm..
3. IF the channel is *busy*, THEN delay *one time slot* and repeat the algorithm.

# P - Persistent CSMA details

- the time slot is usually set to the maximum propagation delay.
- as **p** decreases, stations wait longer to transmit but the number of collisions decreases.
- Consideration for the choice of **p** :
  - (**n x p**) must be  $< 1$  for stability, where **n** is maximum number of stations, i.e.,

$$p < 1/n$$

# CSMA Collisions

- In all three cases a collision is possible.
- CSMA determines collisions by the lack of an ACK which results in a TIMEOUT.  
*{This is extremely expensive with respect to performance.}*
- If a collision occurs, THEN wait a random amount of time and retransmit.

# CSMA/CD

## CSMA with Collision Detection

- If a collision is detected during transmission, THEN immediately cease transmitting the frame.
- The first station to detect a collision sends a *jam signal* to all stations to indicate that there has been a collision.
- After receiving a *jam signal*, a station that was attempting to transmit waits a random amount of time before attempting to retransmit.
- The maximum time needed to detect a collision is 2 x propagation delay.

# CSMA vs CSMA/CD

- CSMA is essentially a historical technology until we include *Wireless LANs*.
- If propagation time is short compared to transmission time, station can be *listening before sending* with CSMA.
- Collision detection (CD) is accomplished by detecting voltage levels outside acceptable range. Thus attenuation limits distance without a repeater.
- If the collision time is short compared to packet time (i.e., small  $a$ ), performance will increase due to CD.



# Maximizing Successful Transmission

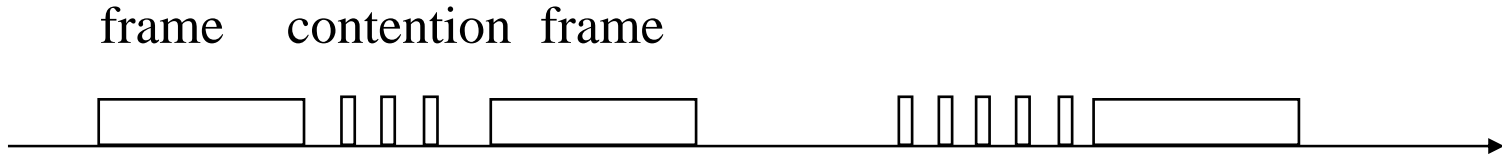

Probability of 1 successful transmission:

$$P_{success} = np(1-p)^{n-1}$$

$P_{success}$  is maximized at  $p=1/n$ :

$$P_{success}^{max} = n\left(1 - \frac{1}{n}\right)^{n-1} \rightarrow \frac{1}{e}$$

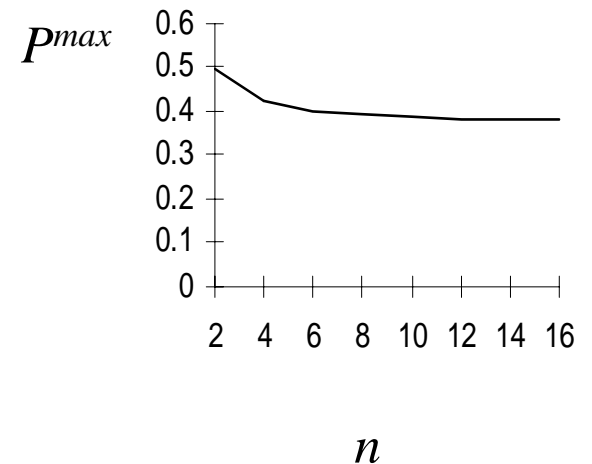

Tanenbaum slide

# Persistent and Non-persistent CSMA

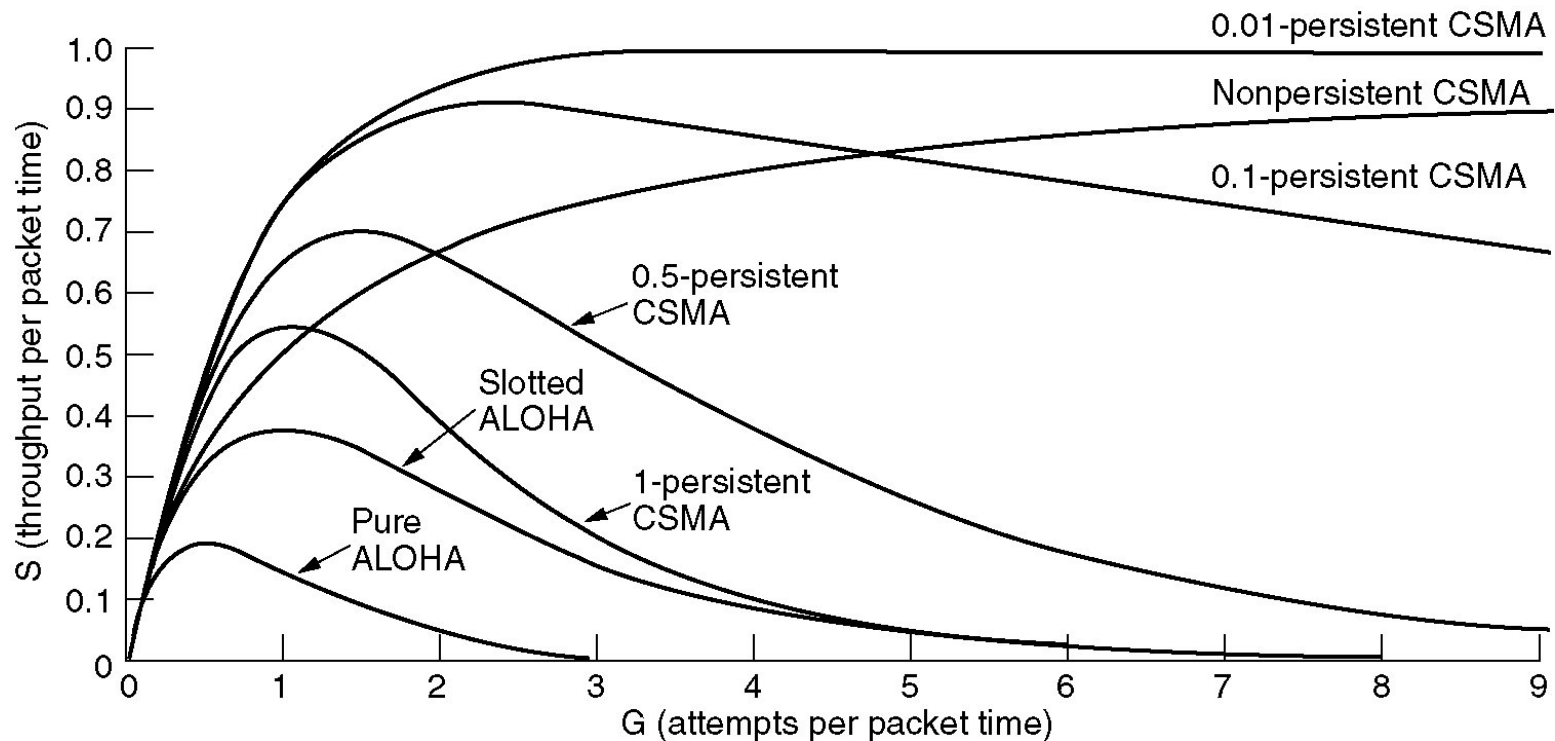
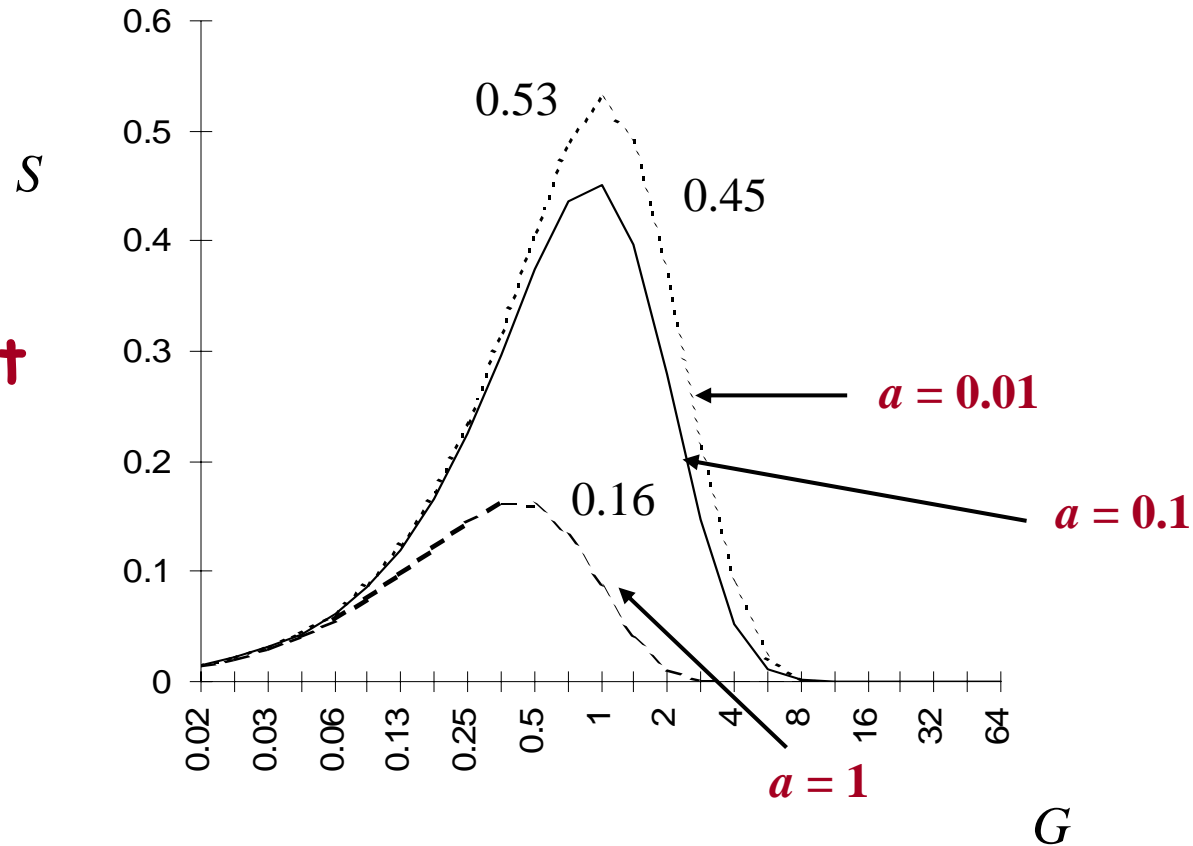

Figure 4-4. Comparison of the channel utilization versus load for various random access protocols.

# Throughput versus Load with varying $a$

1-Persistent  
CSMA



# Throughput versus Load with varying $a$

Non-Persistent  
CSMA

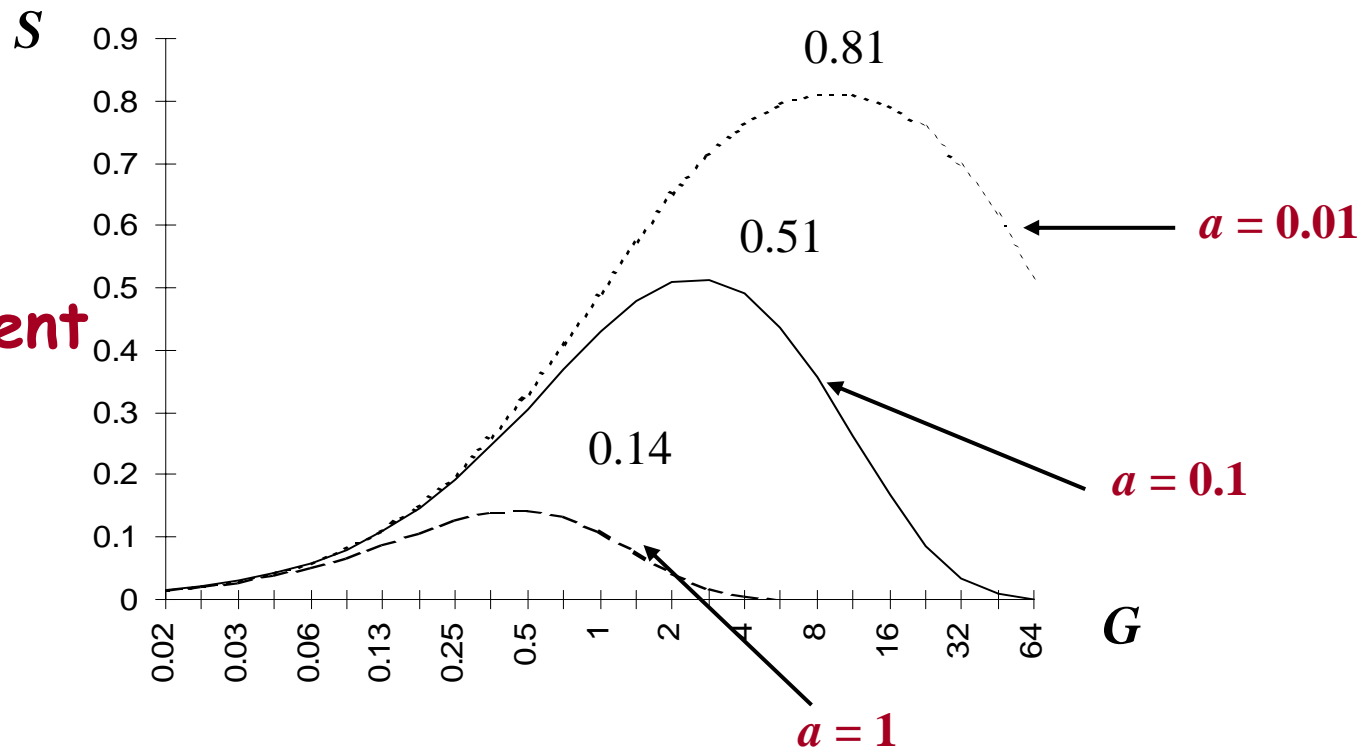

# Maximum Achievable Throughputs

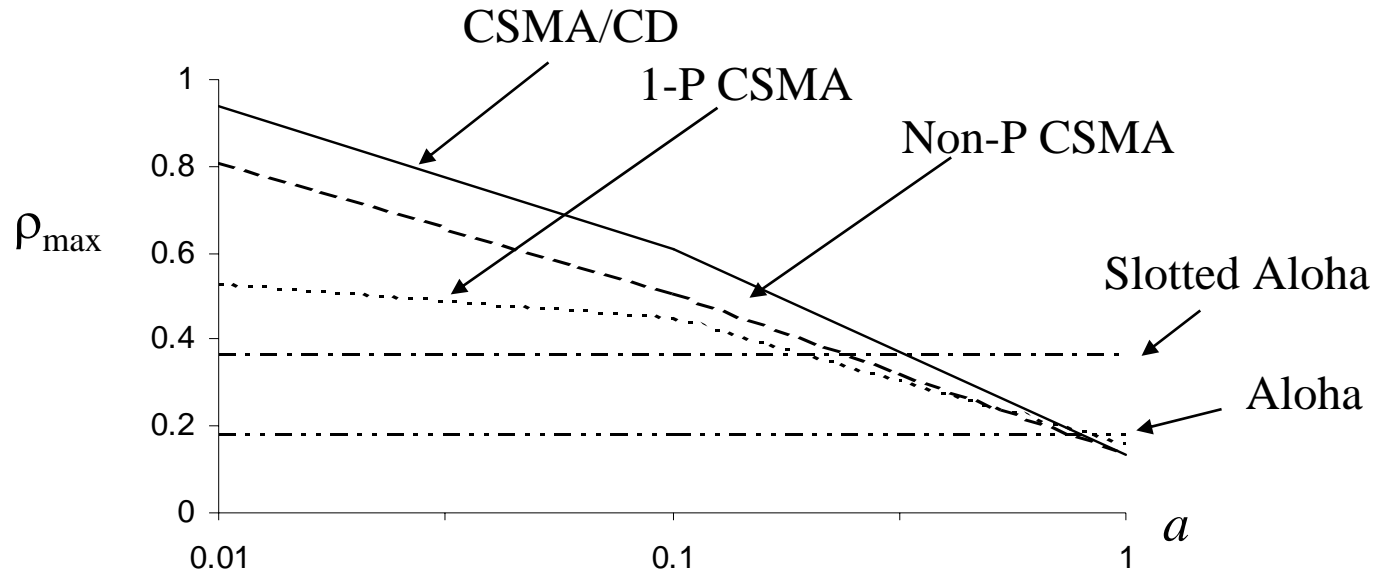

# Frame Delay with varying $a$

