

Envisioning a Traffic Solution for Copenhagen



By: Amager Visioning

Which consists of: Jared Breton, Tanner Buxton, Lucia Shumaker



Envisioning a Traffic Solution for Copenhagen



An Interactive Qualifying Project
submitted to the Faculty of
WORCESTER POLYTECHNIC INSTITUTE
in partial fulfillment of the requirements for the
Degree of Bachelor of Science

In Cooperation With
Miljøpunkt Amager



By:
Jared Breton
Tanner Buxton
Lucia Shumaker

Date:
3 May 2014

Report Submitted to:

Professor Robert Kinicki
Professor Steve Taylor

amagervisioning@wpi.edu

ABSTRACT

Though Copenhagen is trying to set the standards for a green city, thousands of cars clog its main traffic arteries during rush hour on a bi-daily basis. This project provided and evaluated (for Miljøpunkt Amager) a collection of plausible scenarios that focus on reducing motor vehicle congestion in Central Copenhagen, while preserving existing green space. The team conducted interviews, calculated cost and flood capacity, and analyzed traffic models to establish a compelling argument for alternatives to the Eastern Ring Road (E-R) and Ladegårdsåen tunnel proposals. Additionally, the report provides an in-depth discussion of seven tunnel scenarios along with recommendations for a modified combination of the two tunnel routes implemented in conjunction with a congestion charge zone.

TABLE OF CONTENTS

| | |
|--|------|
| Abstract..... | i |
| Table of Contents..... | ii |
| Table of Figures..... | viii |
| Table of Tables..... | xii |
| 1.0 Introduction..... | 1 |
| 2.0 Background..... | 4 |
| 2.1. Introduction..... | 4 |
| 2.2. The History of Urban Planning in Copenhagen..... | 4 |
| 2.2.1. How the Industrial Revolution Changed Urban Planning..... | 5 |
| 2.2.2. The Five Finger Plan for Transit Oriented Development..... | 5 |
| 2.3. Current Development Plans in Copenhagen..... | 7 |
| 2.3.1. The Ørestad Plan..... | 7 |
| 2.3.2. The Ladegårdsåen Traffic Tunnel and Storm Water Management Project..... | 9 |
| 2.3.3. Introduction to the Harbour Tunnel Traffic Management Solution..... | 12 |
| 2.3.4. The Evolution of the Harbour Tunnel – The Eastern Ring Road..... | 13 |
| 2.4. The Primary Problem Miljøpunkt Amager Plans to Address..... | 15 |
| 2.4.1. Copenhagen’s Increasing Traffic Congestion Problem..... | 15 |
| 2.5. The Secondary Problems a Tunnel will Address..... | 18 |
| 2.5.1. Flooding due to Storm Water..... | 18 |
| 2.5.2. The Presence of Air and Noise Pollution in the City..... | 20 |
| 2.5.3. The Lack of Green Space..... | 22 |
| 2.6. Conclusion..... | 23 |
| 3.0 Methodology..... | 25 |
| 3.1. Introduction..... | 25 |
| 3.2. Phase 1 - Situating the Project..... | 28 |
| 3.3. Phase 2 - Gathering Information on Traffic and Flooding..... | 29 |

| | | |
|---------|--|----|
| 3.4. | Phase 3 – Gathering Information on Public Opinion | 30 |
| 3.4.1. | Public Opinion Survey | 31 |
| 3.5. | Phase 4 - Developing a Vision of a New Tunnel | 31 |
| 3.5.1. | Weekly Meetings with Anders Jørn Jensen | 31 |
| 3.5.2. | Processed Information Regarding Existing Tunnel Projects | 32 |
| 3.5.3. | Processed Information on Copenhagen’s Present and Future Building Zones..... | 32 |
| 3.5.4. | Conducted Additional Research on the Implementation of a Congestion Ring | 32 |
| 3.5.5. | Identified Plausible Tunnel Routes | 33 |
| 3.6. | Phase 5 – Evaluating and Comparing Tunnel Scenarios..... | 33 |
| 3.6.1. | The Process for Evaluating Tunnel Scenarios | 33 |
| 3.6.2. | Assigning Weights using a Pairwise Comparison Chart | 34 |
| 3.6.3. | How the Expert Opinions Influence the Decision Matrix | 35 |
| 3.6.4. | Estimating the Cost of a Tunnel Scenario..... | 37 |
| 3.6.5. | Projecting a Tunnel’s Accessibility | 40 |
| 3.6.6. | Estimating a Tunnel’s Floodwater Management Capabilities | 41 |
| 3.6.7. | Estimating the Number of Cars Reduced from Surface Roads..... | 42 |
| 3.6.8. | Calculating the Amount of Preserved Green Space..... | 43 |
| 3.6.9. | Evaluating the Tunnel Scenarios using a Decision Matrix..... | 45 |
| 3.6.10. | Amager Visioning’s Decision Matrix..... | 45 |
| 3.7. | Phase 6 – Deliverables | 46 |
| 3.8. | Conclusion..... | 46 |
| 4.0 | Data & Analysis..... | 47 |
| 4.1. | Interviews | 47 |
| 4.1.1. | Julie Schack – Resident near Metro Construction | 47 |
| 4.1.2. | Nis Fink – HOFOR Water Management Representative..... | 48 |
| 4.1.3. | Susanne Rasmussen – Secretary of Amager West Local Committee..... | 50 |
| 4.1.4. | Lars Weiss – Leader of Social Democrats in Copenhagen City Hall | 51 |
| 4.2. | Scenario Compilation Overview | 53 |

| | | |
|--------|--|----|
| 4.3. | Scenario 1 – Eastern Ring Road..... | 54 |
| 4.3.1. | Eastern Ring Road Tunnel Overview | 55 |
| 4.3.2. | Reasoning behind the Eastern Ring Road Route | 55 |
| 4.3.3. | Thought behind the Traffic Flow | 56 |
| 4.3.4. | Exit and Entrance Locations | 58 |
| 4.3.5. | Pros and Cons of the Eastern Ring Road | 68 |
| 4.4. | Scenario 2 – Eastern Ring Road by Field’s Shopping Center..... | 70 |
| 4.4.1. | Eastern Ring Road by Field’s Overview | 71 |
| 4.4.2. | Reasoning behind Eastern Ring Road by Field’s Route..... | 71 |
| 4.4.3. | Thought behind the Traffic Flow | 74 |
| 4.4.4. | Exit and Entrance Locations | 74 |
| 4.4.5. | Pros and Cons of Eastern Ring Road by Field’s..... | 74 |
| 4.5. | Scenario 3 – Ladegårdsåen Extended Tunnel | 76 |
| 4.5.1. | Ladegårdsåen Extended Tunnel Overview | 77 |
| 4.5.2. | Reasoning behind Ladegårdsåen Extended Tunnel Route..... | 77 |
| 4.5.3. | Thought behind the Traffic Flow | 77 |
| 4.5.4. | Entrance and Exit Locations | 78 |
| 4.5.5. | Inclusion of Parking..... | 78 |
| 4.5.6. | Pros and Cons of the Ladegårdsåen Extended Tunnel..... | 79 |
| 4.6. | Scenario 4 – Ladegårdsåen Extended Tunnel by Field’s Shopping Center | 81 |
| 4.6.1. | Ladegårdsåen Extended Tunnel by Field’s Overview | 82 |
| 4.6.2. | Reasoning behind Ladegårdsåen Extended Tunnel by Field’s Shopping Center ... | 82 |
| 4.6.3. | Thought behind the Traffic Flow | 82 |
| 4.6.4. | Entrance and Exit Locations | 82 |
| 4.6.5. | Inclusion of Parking..... | 83 |
| 4.6.6. | Pros and Cons of Ladegårdsåen Extension by Field’s..... | 83 |
| 4.7. | Scenario 5 – Y-Connection | 84 |
| 4.7.1. | Y-Connection Overview | 85 |

| | | |
|---------|--|-----|
| 4.7.2. | Reasoning behind the Y-Connection Route..... | 86 |
| 4.7.3. | Thought behind the Traffic Flow | 86 |
| 4.7.4. | Entrance and Exit Locations | 86 |
| 4.7.5. | Inclusion of Parking..... | 86 |
| 4.7.6. | Pros and Cons of the Y-Connection..... | 87 |
| 4.8. | Scenario 6 – Y-Connection by Field’s Shopping Center | 88 |
| 4.8.1. | Y-Connection by Field’s Shopping Center Overview | 89 |
| 4.8.2. | Reasoning behind Y-Connection by Field’s Route | 90 |
| 4.8.3. | Thought behind the Traffic Flow | 90 |
| 4.8.4. | Entrance and Exit Locations | 90 |
| 4.8.5. | Inclusion of Parking..... | 90 |
| 4.8.6. | Pros and Cons of Y-Connection by Field’s | 91 |
| 4.9. | Scenario 0 – No Tunnels | 92 |
| 4.9.1. | Scenario 0 Overview..... | 93 |
| 4.9.2. | Reasoning behind having No Tunnels | 93 |
| 4.9.3. | Pros and Cons of Scenario 0..... | 93 |
| 4.10. | Maps & Data | 94 |
| 4.10.1. | Volume Calculation | 94 |
| 4.10.2. | Flooding zones | 96 |
| 4.10.3. | Traffic Estimation..... | 97 |
| 4.10.4. | Tunnel Construction..... | 98 |
| 4.11. | Survey..... | 100 |
| 4.11.1. | Demographics of Survey Participants..... | 100 |
| 4.11.2. | Current Activity in Copenhagen..... | 102 |
| 4.11.3. | Public Awareness..... | 104 |
| 4.11.4. | Amager Fælled..... | 105 |
| 4.11.5. | Metro Connection | 107 |
| 4.11.6. | Conclusions drawn from Survey..... | 108 |

| | | |
|---------|--|-----|
| 4.12. | Additional Service to the Harbor Developments | 109 |
| 4.12.1. | Servicing Nordhavn | 109 |
| 4.12.2. | Servicing Refshaleøen | 110 |
| 4.12.3. | Affordable Public Transportation for Harbor Development Residents | 110 |
| 4.13. | Implementing a Congestion Ring in Copenhagen..... | 111 |
| 4.13.1. | Background of the Toll Situation in Copenhagen..... | 111 |
| 4.13.2. | Surface Tolls vs. In-Tunnel Tolls | 111 |
| 4.13.3. | The London Congestion Zone: A Model for Copenhagen to Follow | 112 |
| 4.13.4. | A Congestion Zone for Copenhagen to Consider | 113 |
| 4.13.5. | Incorporation of Super Bicycle Lanes | 116 |
| 4.14. | Breakdown of the Decision Matrix Weightings..... | 117 |
| 4.14.1. | The Cost Calculator Ranking Table..... | 117 |
| 4.14.2. | The Tunnel Accessibility Ranking Table | 119 |
| 4.14.3. | The Floodwater Management Ranking Table..... | 120 |
| 4.14.4. | The Number of Reduced Cars per Scenario per Major Traffic Artery | 120 |
| 4.14.5. | The Reduced Quantities of Air and Noise Pollution | 121 |
| 4.14.6. | Table Reflecting the Amount of Green Space Preserved | 122 |
| 4.15. | Comparison of the Tunnel Scenarios through using Decision Matrices | 123 |
| 4.15.1. | Nis Fink’s Decision Matrix..... | 123 |
| 4.15.2. | Claus Knudsen’s Decision Matrix | 125 |
| 4.15.3. | Anders Jensen’s Decision Matrix | 127 |
| 4.15.4. | Amager Visioning’s Decision Matrix..... | 129 |
| 4.15.5. | Summary of the Decision Matrix Results..... | 133 |
| 4.15.6. | Conclusion to the Scenario Evaluations | 133 |
| 4.15.7. | Creating a Variation in Results..... | 134 |
| 4.16. | Conclusion..... | 134 |
| 5.0 | Conclusion & Recommendations | 135 |
| 5.1. | A Plan for the Future: Scenario 6 plus City Center Congestion Ring..... | 135 |

| | | |
|---|--|-----|
| 5.1.1. | Nudging Drivers in the Right Direction using a Congestion Ring | 136 |
| 5.1.2. | Using Toll Money to Pay Back Construction Costs | 136 |
| 5.2. | Recommendations | 136 |
| 5.2.1. | Using a Brochure to Raise Public Awareness..... | 137 |
| 5.2.2. | A Vision for Copenhagen | 137 |
| Works Cited | | 138 |
| Appendices..... | | 144 |
| Appendix A – Interviews | | 144 |
| Interview Outline-Anders Rody Hansen (Traffic Expert, Municipal Employee) | | 144 |
| Interview Outline - Nis Fink (HOFOR Representative – Water Management) | | 146 |
| Interview Outline - Lars Weis (Local Politician and Resident of Amager) | | 148 |
| Interview Outline – Resident near the Metro Construction..... | | 150 |
| Appendix B – Public Opinion Survey..... | | 152 |
| Public Opinion Survey..... | | 152 |
| Analysis of Survey Questions..... | | 154 |
| Appendix C – Interview Summary Forms | | 158 |
| Nis Fink Interview Summary Form..... | | 158 |
| Lars Weiss Interview Summary Form..... | | 160 |
| Julie Schack Interview Summary Form..... | | 162 |
| Susanne Rasmussen Discussion Summary Form | | 163 |

TABLE OF FIGURES

| | |
|---|----|
| Figure 1 – Image of the Five Finger Plan (Cahasan & Clark, n.d.) | 6 |
| Figure 2 - Transit Map of Copenhagen (Google Maps, 2014) | 6 |
| Figure 3 - Ørestad City Quadrant Map (By & Havn, 2010) | 8 |
| Figure 4 - Ørestad City Renderings: 2001 and 2010 (By & Havn, 2010) | 9 |
| Figure 5 – Map of Motorways Entering Copenhagen courtesy of Google Maps | 10 |
| Figure 6 - Vision a Tunnel Courtesy of Flood Prevention and Daylighting of Ladegårdsåen | 12 |
| Figure 7 - Copenhagen Harbour Tunnel's Proposed Route ("Harbour Tunnel in Copenhagen,") | 12 |
| Figure 8 - Proposed Eastern Ring Road Route (Transportministeriet, 2013)..... | 13 |
| Figure 9 – Renderings for Possible Nordhavn Development (Architecture)..... | 14 |
| Figure 10 - Map of Eastern Ring Road Route in Amager Fælled (Transportministeriet, 2013) .. | 14 |
| Figure 11 – Map of Metro With Cityringen ("København Cityringen contractors selected," 2010) | 17 |
| Figure 12 - Storm Water Graphs (Jeppeson et al., 2010)..... | 19 |
| Figure 13 – Skybrud 2011 Flooding (Nielsen, 2011) | 20 |
| Figure 14 - Table of Traffic in Copenhagen (Tørsløv, 2010)..... | 21 |
| Figure 15 - Map of Traffic in Copenhagen (Tørsløv, 2010)..... | 22 |
| Figure 16 - The Greening of Kastellet Star Fortress, Copenhagen ("Det Grønne København,") | 22 |
| Figure 17 – Gantt Chart of the Proposed Timeline | 26 |
| Figure 18 – Methods Flow Chart (reads left to right)..... | 27 |
| Figure 19 – Flow Chart Depicting the Process of Evaluating Amager Visioning's Tunnel Scenarios | 34 |

| | |
|--|----|
| Figure 20 – Electronic Form for Ranking the Decision Matrix Categories for Order of Importance | 37 |
| Figure 21 – Area Disturbed by Creation of Scenarios 1, 3, & 5..... | 43 |
| Figure 22 – Area Disturbed by Creation of Scenarios 1,2,5, & 6..... | 44 |
| Figure 23 - Compilation of Tunnel Designs | 53 |
| Figure 24 - The Eastern Ring Road's Route Highlighted on a Satellite Image | 54 |
| Figure 25 – Hypothesized Southbound Traffic Flow for the Eastern Ring Road..... | 56 |
| Figure 26 – Hypothesized Northbound Traffic Flow for the Eastern Ring Road..... | 57 |
| Figure 27 - Satellite Image of Strandvænget and the O2..... | 58 |
| Figure 28 - A View of Strandvænget and the O2 from the South | 59 |
| Figure 29 – Average Number of Cars per Day Over a Year Near Strandvænget..... | 59 |
| Figure 30 - Satellite Image of Nordhavn Harbor Development | 60 |
| Figure 31 - Entrance/Exit to Nordhavn Harbor Development, View from the South | 61 |
| Figure 32 - Eastern Ring Road Entrance/Exit on Nordhavn..... | 61 |
| Figure 33 - Satellite Image of Refshaleøen Harbor Development..... | 62 |
| Figure 34 – Refshalevej, Refshaleøen’s Only Road Entrance/Exit, View from the South | 63 |
| Figure 35 – Eastern Ring Road Entrance/Exit on Refshaleøen | 63 |
| Figure 36 – Satellite Image of Kløvermarksvej..... | 64 |
| Figure 37 – Kløvermarksvej, View from the South..... | 65 |
| Figure 38 – Eastern Ring Road Entrance/Exit near Kløvermarksvej | 65 |
| Figure 39 – Satellite View of Amager Fælled, Artillerivej, and Ørestads Boulevard | 66 |
| Figure 40 – Western Amager's Residential Area Construction Plans | 67 |

| | |
|--|-----|
| Figure 41 – Eastern Ring Road Exit in Amager Fælled and at Artillerivej | 67 |
| Figure 42 – Satellite image of Artillerivej, Sjaellandsbroen, Vejlands Allé, and the E20 | 68 |
| Figure 43 – Eastern Ring Road by Field’s Highlighted Route on a Satellite Image | 70 |
| Figure 44 – DR Byen Metro Station and Construction near the University, View from the South | 72 |
| Figure 45 – View of the E20 Highway West of Fields' Shopping Complex, View from the South | 73 |
| Figure 46 – Housing and Retail Zoning Map of the E20 / Ørestads Blvd. Intersection Area | 73 |
| Figure 47 – Ladegårdsåen Extended Tunnel’s Route Highlighted on a Satellite Image | 76 |
| Figure 48 – Ladegårdsåen Extended Tunnel by Field’s Route Highlighted on a Satellite Image | 81 |
| Figure 49 – The Y-Connection's Route Highlighted on a Satellite Image | 84 |
| Figure 50 – Y-Connection by Field’s Route Highlighted on a Satellite Image..... | 88 |
| Figure 51 – Satellite Image of Copenhagen (No Tunnel)..... | 92 |
| Figure 52 - Tunnel Cross-Section Sketch based on the Cross-Section in Rambøll’s "Østlig Ringvej København" | 95 |
| Figure 53 – 3D Model of Extruded Tunnel Profile..... | 96 |
| Figure 54 – Flooding Map of Amager with Flood Zones..... | 97 |
| Figure 55 – Responses to “How do you feel about the construction in Copenhagen currently?” | 103 |
| Figure 56 – Responses to “What is your opinion on the traffic situation in Copenhagen?” | 104 |
| Figure 57 – Awareness of Traffic Projects and Favorability of E-R | 105 |
| Figure 58 – Summary of Respondents’ Feelings about Amager Faelled | 106 |
| Figure 59 –Respondents’ Feelings about Amager Faelled Being used for Traffic Projects | 107 |

| | |
|--|-----|
| Figure 60 – Respondents’ Interest in a Tunnel if Underground Parking is Provided..... | 108 |
| Figure 61 – Respondents’ Likelihood to use the Metro if Underground Parking is Provided ... | 108 |
| Figure 62 - Complete CPH Metro Directory | 109 |
| Figure 63 – London Congestion Charge Zone..... | 112 |
| Figure 64 – Map Detailing Retail and Monuments in Copenhagen Center..... | 113 |
| Figure 65 – Proposed Congestion Ring around Copenhagen's City Center (excluding Christianshavn)..... | 114 |
| Figure 66 – Proposed Congestion Ring around Copenhagen's City Center (Including Christianshavn)..... | 115 |
| Figure 67 – Super Bike Paths along Copanhagen’s Lakes | 116 |
| Figure 68 – A Plan for the Future: Tunnel Scenario 6 with a Congestion Ring..... | 135 |

TABLE OF TABLES

| | |
|---|----|
| Table 1 – Empty Pairwise Comparison Chart..... | 35 |
| Table 2 – Empty Weighted Percentage Calculator..... | 35 |
| Table 3 – Empty Table for Determining the Direct Cost of Each Tunnel Scenario..... | 37 |
| Table 4 – Empty Table for Determining the Accessibility of Each Tunnel Scenario | 40 |
| Table 5 – Empty Table for Determining Each Scenario’s Floodwater Management Capabilities..... | 41 |
| Table 6 – Empty Table for Determining the Number of Cars Reduced from Surface Roads | 42 |
| Table 7 – Empty Table for Determining Each Scenario’s Amount of Preserved Green Space ... | 43 |
| Table 8 – Empty Table for Determining Each Tunnel Scenario's weight | 45 |
| Table 9 - Overview of Compilation of Tunnels..... | 53 |
| Table 10 – Eastern Ring Road Tunnel Overview | 55 |
| Table 11 – Pros and Cons of Eastern Ring Road Tunnel | 68 |
| Table 12 – Eastern Ring Road by Field’s Overview | 71 |
| Table 13 – Pros and Cons of Eastern Ring Road by Field’s..... | 74 |
| Table 14 – Ladegårdsåen Extended Tunnel Overview | 77 |
| Table 15 – Pros and Cons of Ladegårdsåen Extended Tunnel | 79 |
| Table 16 – Ladegårdsåen Extended Tunnel by Field’s Overview | 82 |
| Table 17 – Pros and Cons of Ladegårdsåen Extended Tunnel by Field’s | 83 |
| Table 18 – Y-Connection Overview | 86 |
| Table 19 – Pros and Cons of Y-Connection | 87 |
| Table 20 – Y-Connection by Field’s Overview | 89 |

| | |
|--|-----|
| Table 21 – Pros and Cons of Y-Connection by Field’s | 91 |
| Table 22 – No Tunnels Overview | 93 |
| Table 23 – Pros and Cons of No Tunnel Scenario..... | 93 |
| Table 24 - Traffic Demand Model (Miljøpunkt Nørrebro Preliminary Traffic Research 2012) .. | 98 |
| Table 25 – Overview of the Studied Alternative Project Designs by Rambøll | 99 |
| Table 26 – Demographics of Survey Participants..... | 102 |
| Table 27 – Tunnel Scenario Cost Ranking Table (1 of 2) | 118 |
| Table 28 - Tunnel Scenario Cost Ranking Table (2 of 2)..... | 118 |
| Table 29 – Tunnel Accessibility Ranking Table..... | 119 |
| Table 30 – Tunnel Floodwater Management Ranking Table | 120 |
| Table 31 – Number of Reduced Surface Cars Ranking Table..... | 121 |
| Table 32 – Preservation of Green Space Ranking Table | 122 |
| Table 33 – Nis Fink's (HOFOR) Decision Matrix | 123 |
| Table 34 – Claus Knudsen's Decision Matrix..... | 126 |
| Table 35 – Anders Jensen's Decision Matrix..... | 128 |
| Table 36 - Amager Visioning's Pairwise Comparison Chart | 130 |
| Table 37 – Amager Visioning's Weight Allocation Table..... | 132 |
| Table 38 - Amager Visioning's Decision Matrix | 132 |

1.0 INTRODUCTION

In the nineteenth century, many cities around the world dramatically evolved because of the Industrial Revolution. Cities were no longer just a place to live and do business, they became the industrial and commercial centers of their countries in a process called “urbanization” (“What is Urbanization?,” 2010). As a result, cities experienced more traffic due to an increase in people within their borders and green space was lost to the construction of houses and factories. The constructed factories increased the air pollution to dangerous amounts in the neighboring areas due to harmful carbon particulate they emitted. In addition, the loss of green space and other permeable surfaces in cities left rainwater with few places to go besides the streets. If left unaddressed, urbanization in cities can cause serious environmental problems that are harmful to the city’s infrastructure and its inhabitants.

Denmark, like many countries in Europe, has a long history of urbanization that dates back to the eleventh century. A country built on fishing and trade, Denmark has lost vital green space over the years to the construction of its cities. In the nineteenth century when the Industrial Revolution hit, the large population increase resulted in the rapid increase in construction and the rapid decrease in green space. Road traffic also increased as residents made their way to work, merchants tried to sell their goods, and people tried to get across town. In 1947 after the tumultuous World War II, Denmark’s capital city, Copenhagen, realized that economic growth was soon going to put a burden on the city’s road networks and infrastructure. That year, they adopted a new method of urban planning called transit-oriented development, in which they developed the Five Finger Plan. This plan placed the city at the heart of transit and placed five road networks, or fingers, extending out from the city. The goal was to increase the ease of travel to and from the city center. In addition, Copenhagen added roads, called city rings, which connect the fingers together to keep traffic that does not need to be in the city out.

While roads help the city become well connected, they also provide more space for cars. Since 1990, there was a 27% increase in traffic across city borders (Københavns Kommune; n.d.). Increased traffic into the city was positive during the early industrial periods, but now there are health issues associated with too much vehicular transit. High noise levels can cause hypertension, heart attacks, and strokes. In 2006, 173,000 dwellings, over half the dwellings in Copenhagen, were affected by noise levels above the EPA safety standard of 58 dB (Københavns

Kommune, n.d.). Air pollution is also a result of the increased amount of traffic. Harmful pollution levels can lead to cancer, cardiovascular morbidity, heightened symptoms to people with asthma, and unhealthy births (Krzyzanowski, 2005). Copenhagen remains at an unhealthy level of 25% over the EU's limit value, $40 \mu\text{g}/\text{m}^3$, for nitrogen dioxide air content ("Københavns Kommune," n.d.).

In recent years, the city has strived to be more modern and livable for its citizens. The city of Copenhagen declared that by 2015 the air should be sufficiently clean so as not to damage its inhabitants' health. There has also been a 19.2% decrease of traffic into the city center from 2000-2012. Noise has also dropped so that only 141,000 homes, which is 32,000 less, are affected by noises over 58 dB ("Københavns Kommune," n.d.). Decreasing traffic congestion in the city reduces the noise and air pollution that harm the people's health.

One urban planning strategy that has reduced air and noise pollution from cars is to put the cars in a tunnel below ground. Moving traffic underground has also lessened traffic congestion. From 1991 to 2006, with nine years of prior planning, the city of Boston undertook the Big Dig to decrease the air and noise pollution in the area ("The Big Dig - Project Background," n.d.). The Big Dig also addressed Boston's main problem, traffic congestion, by moving part of Interstate-93 underground in a network of tunnels. Before the Big Dig, traffic models predicted traffic jams of up to sixteen hours long by the year 2010 ("The Big Dig - Project Background," n.d.). That is no longer an issue.

With the Big Dig's success, Copenhagen plans to adopt a similar method to alleviate its traffic concerns in the city center. The current plan, called the Eastern Ring Road (E-R), reroutes traffic trying to go through the city, underground from Østerbro to western Amager (Group, 2014). The E-R connects areas like Nordhavn and Refshaleøen, which are somewhat isolated, to the rest of the city. Theoretically, this plan will reduce the traffic flow in the subsequent regions by providing accessible entrance and exit points. In addition, it will prevent traffic heading for the E20 highway from entering the densest areas of the city (Group, 2014).

However, the last segment of the E-R surfaces in Amager Fælled, a local park and conservation land on Amager, and proceeds to connect to the Øresundmotorvejen (the E20). This is a problem for our sponsor, Miljøpunkt Amager, an environmental points company focused on preserving and improving the green spaces and infrastructure of Amager to improve the island's overall

livability. They see the Eastern Ring Road as a solution for part of Copenhagen, but not for all of its neighborhoods, because it directs traffic onto Amager and ruins the last natural large plot of green space in the city. If the tunnel were to surface in Amager Fælled, the boring site and road would carve through it and expel the deer, mallards, and other wildlife from their habitat. The loud noise, destruction of trees, and influx of motor vehicles would cause extensive damage that would take countless years to repair if possible to repair at all (Personal contact with Susanne Rasmussen of Amager Vest Lokaludvalg, 2014).

Miljøpunkt Amager believes that another viable tunnel can be designed that would not destroy Amager Fælled while still diverting traffic away from the city center. The only other current tunnel proposal is the WPI Ladegårdsåen project done in 2012. It not only diverts traffic, but also preserves green space, and reduces flooding and pollution. A similar tunnel through the city center would be beneficial to people walking and people taking cars. The lack of a substantive alternative has left the E-R as the primary plan. Currently there exists many opinions both for and against the E-R, but no real decision as to whether the benefits outweigh the costs.

The purpose of this project was to inform the people of Copenhagen of the possibility of alternate tunnel routes by evaluating different tunnel scenarios, through use of public opinion and a decision matrix. Evaluating the seven tunnel scenarios involved choosing different routes, public opinion on the different options, and technical measurements on tunnel designs. The technical measurements included estimations of cost, size, reduction of cars, and preservation of green space. The primary purpose of any tunnel scenario is to reduce traffic through the city and to preserve the existing green space. Our final deliverables were an evaluation of the tunnel scenarios that Miljøpunkt Amager can present to the public in order to illustrate the possibility of different tunnel options in Copenhagen.

2.0 BACKGROUND

2.1. Introduction

Throughout history, cities have had to adapt to changing needs and threats, including increasing populations, advancing technology, and changing climates. Copenhagen has successfully adapted over the course of time, from its beginning as a fifteenth century fishing village to its current state as a modern city. Copenhagen's population and the number of cars on the road are increasing annually. Urban planning efforts must adapt to cope with the increasing motor traffic congestion. In addition, the recent increase in powerful rainstorms has caused major flooding and significant material damages to the city's infrastructure. The city of Copenhagen is making efforts to solve these problems in ways that will help the city achieve its goal of being a carbon neutral by the year 2025. One proposed solution is to use dual-purpose underground tunnels for traffic diversion and storm water drainage. These tunnels not only address the primary problem of traffic, but also provide underground networks for water reservoirs during high rainfall. Moving traffic underground blocks noise and harmful air pollutants from reaching the surface while creating space above ground for parks and green space. This chapter presents relevant background information to the project, including a discussion of Copenhagen's urban planning and examples of the city's current infrastructure plans. The chapter also explores the primary motivation for the project—traffic congestion—and the secondary problems—storm water, air and noise pollution, and lack of urban green spaces.

2.2. The History of Urban Planning in Copenhagen

Many cities struggle with difficulties related to urban planning. This involves the technical planning of an urban environment considering land usage, transportation, and community development. Evolving cities have required a parallel evolution in urban planning. Copenhagen must consider the changing needs of the city as the number of cars on the road increases and there are increasingly frequent weather events with large amounts of rainfall. Copenhagen adopted the Five Finger Plan in 1947 to shape the city in order to integrate green space and transportation routes. Presently, there are many different visions of city infrastructure that would benefit the city by increasing mobility through the city.

[2.2.1. How the Industrial Revolution Changed Urban Planning](#)

Urban planning began to gain traction as an important field in the 19th century. Prior to the Industrial Revolution, there was little forethought for future technology and transit in city design. As a result of the introduction of the automobile, cities during and after the Industrial Revolution were unhealthy and inefficient, despite their greater levels of wealth and access to energy when compared to suburban and rural communities (Campbell, 2012). In 1893, Daniel Burnham and Frederick Olmstead used a new style, the City Beautiful Movement, mimicking the style of Paris to design the fairgrounds for the World's Columbian Exposition in Chicago (Congress, 2013). This movement was the United States' first attempt at modern urban planning; the movement focused on improving living conditions and civic virtues through the beautification of the city. Subsequently, several movements took shape, including the Garden City movement proposed by Ebenezer Howard in 1898. In 1902, the McMillan Plan based on the City Beautiful Movement, initiated the redesign of Washington D.C.; refocusing on the monuments of the capital and the placement of the more recent monuments including the Lincoln Memorial, Union Station, and the Ulysses S. Grant Memorial (Reps, n.d.). The Industrial Revolution was a turning point in city planning. The idea behind the Garden City movement was that cities would be surrounded by parks and would incorporate areas of mixed residence and industry (Hall & Mark, 2011). This movement became the model for many cities.

[2.2.2. The Five Finger Plan for Transit Oriented Development](#)

In the mid-19th century, ramparts surrounded Copenhagen, limiting the city to 130,000 inhabitants within three square kilometers. After the Industrial Revolution, the city expanded by utilizing transit oriented development, and creating a train system which would enable development outside the city. The train system spread into neighboring towns, which allowed the areas to develop into a middle-class sector. In 1947, architect Peter Bredsdorff developed the Five Finger plan which the government enacted through local zoning decisions (Kulturkanonen, 2014). The Five Finger plan stated that the public should have easy access to green space, bike paths, commuter rails, and motorways (Cahasan & Clark, n.d.). The Five Finger plan focused on having community growth within linear corridors that resembled fingers, as seen in Figure 1.

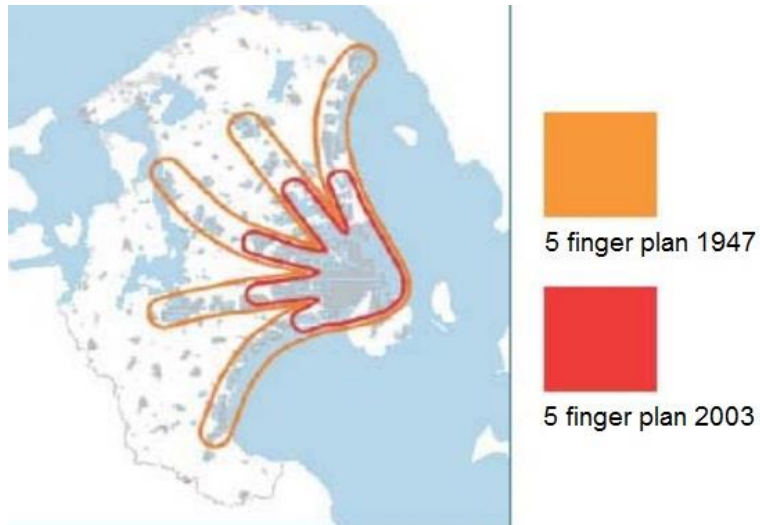

Figure 1 – Image of the Five Finger Plan (Cahasan & Clark, n.d.)

The plan included green space in the areas between the fingers. The transportation along the corridors formed the skeleton for development. A major highway and a transit line ran along each finger. These transit lines are highlighted in black, below in Figure 2. Unless otherwise noted, all maps have been taken from Google Maps. Some, including the following figure, have been modified by the authors for use in this document.



Figure 2 - Transit Map of Copenhagen (Google Maps, 2014)

The figure above shows the rail lines, including the Metro lines, highlighted in gray, on the

island of Amager. Development occurred along the Metro lines to the airport, similar to the development of the other fingers, causing the growth of an additional finger (Knowles, 2012). With the incorporation of the airport and the Øresund Bridge, this finger is an international constituent. The Metro system attracts more travel to Copenhagen Airport than any of the other stops along the line (Knowles, 2012). The most recent development along these lines was Ørestad, in Amager Vest.

Copenhagen has focused on replacing spaces for cars in the city with places for people to walk and cycle. The Five Finger plan allows commuters choose between traveling into the city by train or motor vehicle. Urban planners are encouraging the development of more pedestrian space to make a more inviting, vibrant, and healthy city (Cahasan & Clark, n.d.). The Five Finger plan has driven development for over 60 years, and continued growth is expected. By 2025, the city is expected to grow by 100,000 people per year (Cahasan & Clark, n.d.). Focus has largely been centered around the improvements of the harbor area and the development of Ørestad by the company, By & Havn ("Vision and Mission," n.d.). By & Havn is a company whose mission is to create a vibrant neighborhood that is attractive to both live and work in ("Vision and Mission," n.d.).

2.3. Current Development Plans in Copenhagen

Four major current Danish development plans relate to our project. The Ørestad plan is an extension of the Five Finger Plan, which uses the Metro to aid its development and runs along Amager Fælled, a large area of natural conservation land. The Ladegårdsåen Tunnel project strives to reduce storm water flooding along Ågade and Åboulevard (in the district of Nørrebro) while increasing green space. The Harbour Tunnel and Eastern Ring Road projects create an underground route for through traffic to alleviate surface traffic congestion, air pollution, and noise pollution in the center of Copenhagen.

2.3.1. [The Ørestad Plan](#)

In the 1980's Copenhagen was suffering from low economic growth and high unemployment rates. The development of the Øresund Bridge, extension of the airport, and creation of the Metro and Ørestad were the foundation for renewed growth in Copenhagen. The creation of the Metro and Ørestad are important to discuss due to this project's consideration of a tunnel route along the M1 line that borders Amager Fælled and services Ørestad.

In 1993, the Ørestadsselskabet I/S (Ørestad Development Corporation) was established to lead the development of the Metro and Ørestad and in 1994 a Finnish architectural firm won a competition to create the master plan for Ørestad (BY&HAVN, 2010). The Finnish plan limited construction to four smaller districts rather than one large strip, which would allow for the preservation of green space between the districts (BY&HAVN, 2010). Figure 3 outlines the four districts, Ørestad Nord, Amager Fælled Kvarter, Ørestad City, and Ørestad Syd, in addition to the Metro stops that service the development. Portions of the development were already completed. The development is next to Amager Fælled (a large nature conservation area in Copenhagen), a manmade canal, and along the Metro line. Sustainability is the focal point of the design of Ørestad. It has limited and expensive car parking, good bicycle lanes, and is purposefully close to the Metro (Knowles, 2012). The combination of nature, water and easy transportation also makes Ørestad a valuable developing area.



Figure 3 - Ørestad City Quadrant Map (By & Havn, 2010)

Ørestad is the sixth finger of the Five Finger Plan, created by the government to introduce more residential and business zones within Copenhagen (Knowles, 2012). Ørestad is also meant to act as a connection between Old Copenhagen, the airport, and the Øresund Bridge to Sweden (BY&HAVN, 2010). The new development would act as a strip of residents, green space, and international businesses. The proximity of the newest development to the city center makes it an attractive location for both people looking to get out of the city, and people looking to move closer to the city, and as a location for international corporations.

Currently Ørestad is incomplete and only 10 years into its 30-year planned development (disPATCH, 2013). Construction has not started on Amager Fælled Kvarter, and there is still minor construction planned for the other three zones. Despite being incomplete, Ferring Pharmaceutical Company (one of the first large companies) moved into Ørestad in 2002, Field's,

Scandinavia's largest shopping center, opened in 2004 and by 2010, 6142 residents had moved into Ørestad. Københavns Energi, The Metro Company, Rambøll Engineering, Crown Plaza, Hotel Cabinn Metro, and Bella Hotel have also relocated to the area (BY&HAVN, 2010). The figure below shows the development of Ørestad city over the course of nine years.



Figure 4 - Ørestad City Renderings: 2001 and 2010 (By & Havn, 2010)

2.3.2. [The Ladegårdsåen Traffic Tunnel and Storm Water Management Project](#)

The Five Finger plan created five major suburban areas outside of Copenhagen. The two most northern fingers contain nearly 400,000 inhabitants. These two fingers stretch along the Hillerød motorvejen [16] and the Helsingør motorvejen [19] as seen in Figure 5.

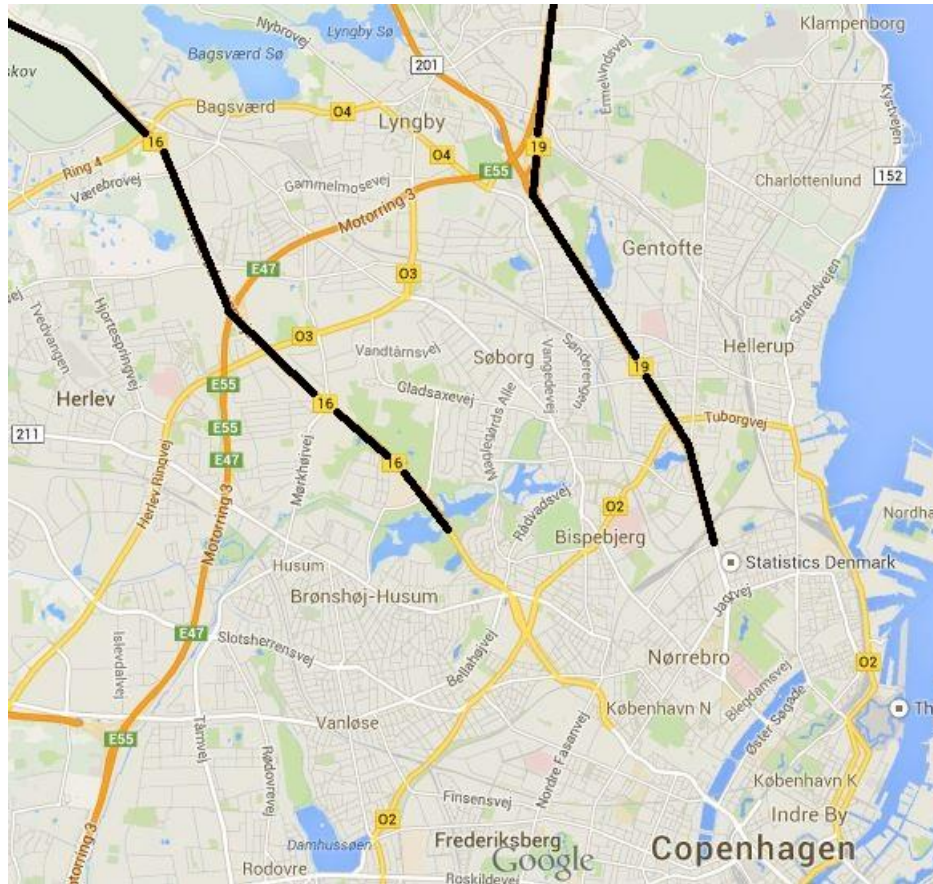

Figure 5 – Map of Motorways Entering Copenhagen courtesy of Google Maps

The two highways lead directly into the center of Copenhagen. The most direct route from these highways to either the Copenhagen airport or Sweden is by traveling along HC Andersens Boulevard and Amagerbrogade. Hillerødmotorvejen turns into Åboulevard, which then leads to HC Andersens Boulevard. In 2012, a Worcester Polytechnic Institute project team studied the possibility of daylighting a canal under Åboulevard. The Ladegårdsåen Daylighting involves removing the existing road and bringing a piped canal that once existed on the surface back to the daylight, by diverting the traffic either to other streets or into a newly formed tunnel underneath the canal. This project won the 2012 best Vision of Copenhagen award by Politiken. The goal of the project was to assist Miljøpunkt Nørrebro with selecting a pathway for the reopening of the piped canal, and in doing so the WPI team identified design options that could help the city add green space and alleviate flooding along the route (Christiansen, 2013). The team compared the feasibility of daylighting along two different routes, Ågade and Åboulevard or Borups Allé-Rantzausgade. To provide a solution, the project team researched various issues including, green space usage, flooding zones, pollution, the history of Nørrebro and the

Ladegårdsåen canal, a daylighting project in Aarhus, and on-site studies.

Determining which area experienced more flooding drove their research. They discovered that the Ågade and Åboulevard route suffered the most during a one hundred year storm that drenched the city in 2011. They also learned that green space usage in Copenhagen was limited and although there was a desire to create more green space, and based on their research, either location would add green space to the city.

This project also investigated air and noise pollution in the area. To determine the actual impact of noise and air pollution, the project team utilized previously published maps to show the different levels of pollution along their proposed routes. In both cases, the Ågade and Åboulevard route had a significantly greater threat of pollution than the Borups Allé-Rantzausgade did. By studying the history of Nørrebro, the team discerned the history of the canal, including the reason the city decided to pipe it, and any previous efforts to daylight the canal.

Daylighting the Ladegårdsåen canal could reduce the traffic volume on one of Copenhagen's busiest streets, Åboulevard, as well as alleviate flooding during large storms, and increase the amount of green space in the city. Previous project proposals suggested that a tunnel would cost upwards of 10-15 billion kroner, however because the new proposal suggests a cut-and-cover method for construction, rather than boring, the cost has been lowered to around 4-5 billion kroner (Christiansen, 2013). The daylighting project provides several design suggestions that could solve the previously discussed issues. The Åboulevard route was the more effective route and thus the route that they suggested for daylighting.

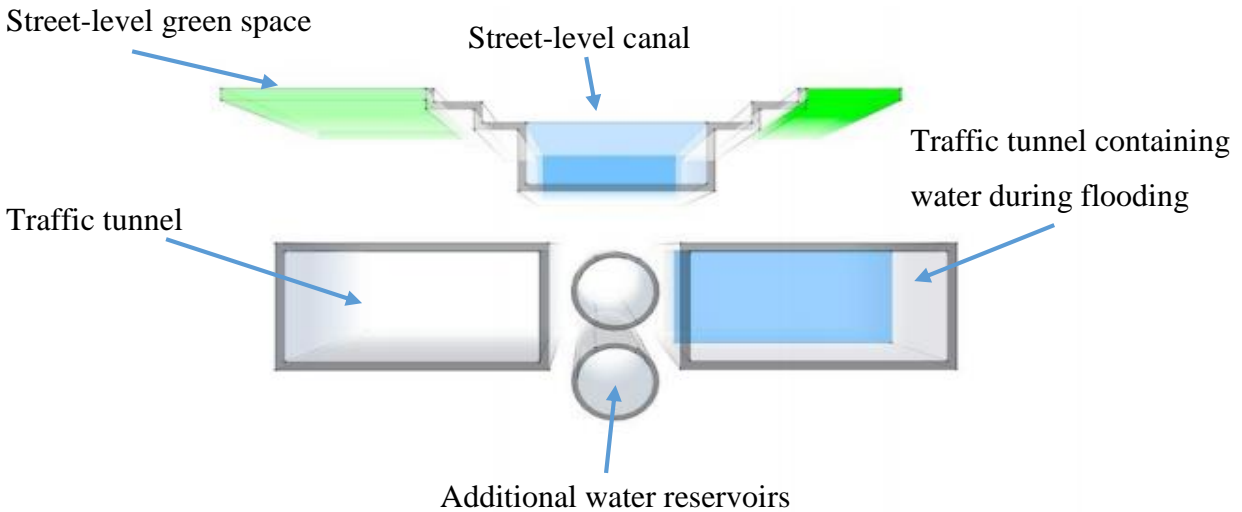

Figure 6 - Vision a Tunnel Courtesy of Flood Prevention and Daylighting of Ladegårdsåen

The above figure shows the tunnel design suggested to Miljøpunkt Nørrebro that would run under the canal. Motor vehicles would drive through the two rectangular tunnels. In the case of massive flooding, the tunnels could act as extra reservoir space that could be drained later. The tunnel concept comes from the ideas of the Storm water Management and Road Tunnel (SMART) project completed in Malaysia in 2007. The team also provided surface level designs that incorporated green space, footbridge design and location, and bike path design. Money was set aside in the 2014 city budget to perform a more detailed feasibility study on the possibility of daylighting the Ladegårdsåen (CW, 2013).

2.3.3. [Introduction to the Harbour Tunnel Traffic Management Solution](#)

In the early 2000s, the urban planning firm SLA proposed a solution to Copenhagen’s inner city

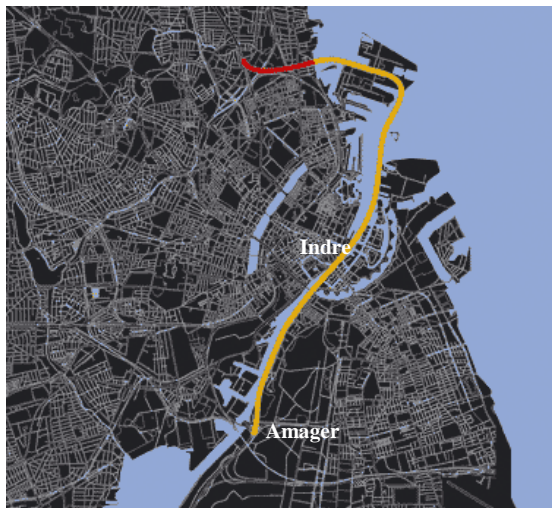

Figure 7 - Copenhagen Harbour Tunnel's Proposed Route ("Harbour Tunnel in Copenhagen,")

traffic congestion problem, and called it the Harbour Tunnel. This tunnel design provides a link between traffic in Østerbro and on Indre By to Amager Fælled ("Harbour Tunnel in Copenhagen," n.d.). This will remove through traffic from the center of Copenhagen and create more space for cyclists, pedestrians, and buses. It also reduces the amount of harmful carbon emissions and noise pollution in the area by placing the cars underground. However, the city abandoned the plan to put a twelve-kilometer

tunnel in the harbor because its sediment contains high mercury levels (Personal contact with Asger Gad of Miljøpunkt Amager, 2014). Building the tunnel would release the mercury into the water, which would introduce a new set of problems to the already costly project.

2.3.4. The Evolution of the Harbour Tunnel – The Eastern Ring Road

In response to the Harbour Tunnel proposal, an international urban planning firm called Rambøll¹ proposed an adaptation of the Harbour Tunnel called the Eastern Ring Road (Transportministeriet, 2013). Its route is similar to the Harbour Tunnel's; however instead of following the harbor along Amager, the E-R's route crosses the harbor between Nordhavn and Refshaleøen, then loops west to Amager Fælled's northern tip (seen in Figure 8). Similar to the Harbour Tunnel plan, the E-R design focuses on bringing the surface traffic going through Indre By (the inner city), Islands Brygge, Østerbro, and Christianshavn, underground (Wimmelmann, 2009). This will protect the residents in these areas from unnecessary traffic, harmful carbon emissions that cars emit, and noise pollution.

As a result of its route, the E-R is estimated to be half a kilometer longer than the Harbour Tunnel and will have four exits into the city (marked by the red X's in Figure 8) before it connects with the E20 highway to form the eastern ring around the city (hence its name). These exits provide drivers with the opportunity to do two things: funnel into the area surrounding the entrance, thus creating congestion in neighborhoods that may not want it; and funneling out of the tunnel into the neighborhoods surrounding the exits, thus creating more traffic flow than normal.



Figure 8 - Proposed Eastern Ring Road Route (Transportministeriet, 2013)

¹ Rambøll is an international urban planning firm based in Copenhagen. Its focuses are on improving the infrastructure and livability of the regions its projects affect.

Nordhavn and Refshaleøen will especially feel the effects due to an increased traffic flow. Nordhavn, which will provide housing and green space to the local community, is still in



Figure 9 – Renderings for Possible Nordhavn Development (Architecture)

development. Refshaleøen is also on the table for development. It is currently a prospective development area and the city plans for it to have housing and recreational green space before 2050 (Architecture, n.d.). With each of these two development zones being peninsulas, some may argue that it is necessary to put a road in place that will allow their future residents to travel to Amager and Østerbro. Others argue that it may encourage the use of cars in these developments, which is the opposite of Copenhagen’s intent in encouraging the use of bicycles and public transportation. This divide in opinion is one of the major reasons the public and politicians alike cannot decide on whether the E-R is the right solution to Copenhagen’s traffic congestion problem.

The other major reason is the surfacing of the E-R in Amager Fælled, which is the large section of green space in Amager Vest (western Amager). With small sections of Amager Fælled set to be developed and its area rapidly shrinking, surfacing a tunnel and extending a highway through the area will have crippling effects to its ecosystem. Additionally, the people who live in the residential region outlined by the red box in Figure 10 do not want the E-R built because the construction in the area will be disruptive and there would be an unwanted increase in traffic (Personal contact with Susanne Rasmussen of Amager Vest Lokaludvalg, 2014).



Figure 10 - Map of Eastern Ring Road Route in Amager Fælled (Transportministeriet, 2013)

While the E-R promises to remove cars from central Copenhagen, reducing harmful carbon emissions, and reducing noise pollution, the negative effects its construction and surfacing locations will have on the environment could prove too detrimental to the city to approve. Thus, this plan is highly debated amongst both the general public and politicians. Many politicians and residents of Østerbro and Indre By favor the E-R because it will remove through traffic from their districts. However, many of Amager's residents oppose the construction of the E-R because it will dump traffic into their district and will destroy portions Amager Fælled, a valued natural area. Our sponsoring agency, Miljøpunkt Amager, has decided to investigate alternatives to the previously discussed tunnel plans that will please a greater portion of Copenhagen and keep Amager's green space intact.

2.4. The Primary Problem Miljøpunkt Amager Plans to Address

The primary problem that Miljøpunkt Amager plans to address is traffic congestion in the city. Expansion of the city is a reality and an attempt to move people away from driving has been made. However, the number of cars has not reduced over the years; it continues to grow regardless of the efforts put in by the city. The city has implemented more public transportation and a friendlier bike environment in order to improve the congestion in the city. By building a tunnel, cars will take the tunnel rather than traveling along the busy streets of the central city in order to get across the city. At the current rate, traffic will increase in the future unless more efforts are made to reduce the number of cars, or implement more stringent vehicle usage.

2.4.1. Copenhagen's Increasing Traffic Congestion Problem

Copenhagen is experiencing population growth due to increased immigration from other countries ("Denmark Population: Historical Data Graphs per Year," n.d.). As the population continues to grow so does the need for transportation. Since 1988 there has been a 50% increase in traffic, with a similar increase expected for the foreseeable future ("Sustainable Transport- Better Infrastructure," 2008). The transportation sector accounts for nearly 25% of CO₂ emissions, however with the expected traffic increase, emissions will increase ("Sustainable Transport- Better Infrastructure," 2008). In 2008, the EU-27 average for road transport emissions is 1.99 tons, but Denmark contributes 5 tons of CO₂ per capita ("Danish Green Transport Plan to get the Environment Back on Track," 2011). Denmark is attempting to reduce these emissions by enacting several key actions including, reduced green car taxes, investment in public

transportation, intelligent traffic systems, new roads strategy, and funding for public research into green transport technologies ("Danish Green Transport Plan to get the Environment Back on Track," 2011). Roads and transportation are the areas that require action in order to reduce the emissions.

Already Copenhagen has a history of being a cycling and overall green city. Copenhagen has a 100-year history of cycling. Cycling started becoming a major form of transportation in the first half of the twentieth century, but by World War II, cars began taking precedence (Ruby, n.d.). However, the 1973 Oil Crisis caused a relapse into the use of bicycles, which have had a strong position in transit system of Copenhagen ever since. With the increase in laws that assist cyclists to be more protected and the separated lanes that are devoted specifically to bicycles it has become much easier and more efficient to cycle through Copenhagen (Lindholm, n.d.). Copenhagen continues to initiate new policies that provide for a faster, safer, and more comfortable cycling experience ("Good, Better, Best: The City of Copenhagen's Bicycle Strategy 2011-2015," 2014).

The Copenhagen Metro, recently completed as of 2007, is one of the most recent projects that the city has done to reduce the amount of traffic affecting the city. The Metro system has two lines currently; M1 goes from Vestamager to Vanløse (Frederiksberg), while M2 runs from Lufthavnen (Copenhagen Airport) to Vanløse. The Metro system in Copenhagen is very reliable with 4 minute intervals between trains, and a punctuality of 98.2% ("Copenhagen Metro," n.d.). The system operates without a driver and was voted the "World's Best Driverless Metro" ("Copenhagen Metro," n.d.). In 2002, the first line of the Metro's completion led to a change in transportation for the city. With the introduction of the Copenhagen Metro, about 26,000 previous bus users started taking the Metro by 2003, and approximately 3000-5000 car trips across the harbor switched over to the Metro as well (Vuk, 2005).



Figure 11 – Map of Metro With Cityringen ("København Cityringen contractors selected," 2010)

Copenhagen hopes to add two more lines (the Cityringen, in blue and orange in Figure 11) to their Metro system that will encompass Nørrebro, Østerbro, and lower parts of Frederiksberg ("Metro," n.d.). The addition of the two newest lines are expected to be completed by 2018 at a cost of approximately 21 billion kroner ("København Cityringen contractors selected," 2010). The addition of these two lines, similar to the first two lines should reduce traffic from Nørrebro & Østerbro. The current Metro system works alongside the S-Tog, the old train system, which has been transporting people since 1934.

Efforts to implement a stronger cycling culture and a more reliable Metro system will expectedly reduce traffic. However, the roads remain the same despite the changing policies to reduce the amount of traffic. One of the main issues, especially in Copenhagen, is that the streets are narrow due to the fact that it is an old city ("Good, Better, Best: The City of Copenhagen's Bicycle Strategy 2011-2015," 2014). Main streets are only two lanes wide with an additional bus lane and a bike path.

The Ladegårdsåen project is an example of how designers can consider pedestrian and vehicular transportation when designing. Copenhagen has been actively solving their goals, and they continue to solve more and explore new areas in which to reduce traffic and make its transportation cleaner. Smart urban planning will solve transportation issues as well as the

problems caused by traffic congestion.

2.5. The Secondary Problems a Tunnel will Address

Although decreasing traffic congestion has become the primary focal point of tunnel design in Amager, building a tunnel will also address additional problems the city faces. The first problem is storm water flooding in the streets of Copenhagen. It is difficult to manage flooding due to storms in Copenhagen because the region is relatively flat and the sewers cannot handle the volume of water that recent heavy storms have dropped on Copenhagen. Another motivation for building a tunnel is the air and noise pollution in the city of Copenhagen. When cars travel through the city, they release greenhouse gases into the environment, which, in higher concentrations, can be hazardous to human health. Motor vehicle traffic also contributes to noise pollution, which decreases the livability of the city and can damage human hearing capabilities or have negative psychological effects. The lack of green space in Copenhagen, which the Five Finger Plan has been aiming to improve since 1947, is an additional motivation for reducing surface traffic by building a tunnel. Exploring these problems provides a clearer understanding of how they harm the city and its goals of reaching carbon neutrality by 2025 (Gerdes, 2013). Construction of a tunnel can address these secondary problems and the result will ultimately improve the livability of Amager and the city of Copenhagen.

2.5.1. Flooding due to Storm Water

Copenhagen has struggled with flooding due to increased amounts of rainfall. Since the middle of the nineteenth century, annual precipitation has increased by 129 millimeters per year and continues to increase due to a recent shift in climate patterns (Jeppeson, Christensen, & Ladekarl, 2010). At the same time, the rainwater that is falling in the city cannot permeate because of the use of impermeable building materials like asphalt, cobblestone, brick, and concrete. Combined with the island of Amager's low-lying topography, the increased amounts of rainwater have nowhere to flow and remain stagnant in streets. This inhibits most forms of transportation from navigating the streets as well as costing Copenhagen taxpayers billions of kroner in water damage each year (Buley, 2011). In addition to the city infrastructure's inability to cope with storm water, powerful downpours and winter cyclones have pelted Denmark and its neighboring Baltic Sea countries more frequently than previously experienced.

Cloudbursts, a weather system characterized by its fast pace, intense lightning, and powerful

downpours, affect areas around the equator, areas of the Baltic Sea, and Denmark. Since 2005 this type of storm system has been the largest contributor to rainfall totals in Copenhagen (Vestergaard, 2011). The summer of 2007 experienced the most precipitation of these months, with three major cloudbursts occurring between the months of July and August. The storms dropped as much as fifty-three millimeters in ten minutes (Vestergaard, 2011). This devastating rate of precipitation is difficult for even permeable surfaces like natural soil to absorb. As Copenhagen is a city made of impermeable and semi-permeable materials, rainwater is not easily absorbed and is all directed to drainage pipes and the sewers.

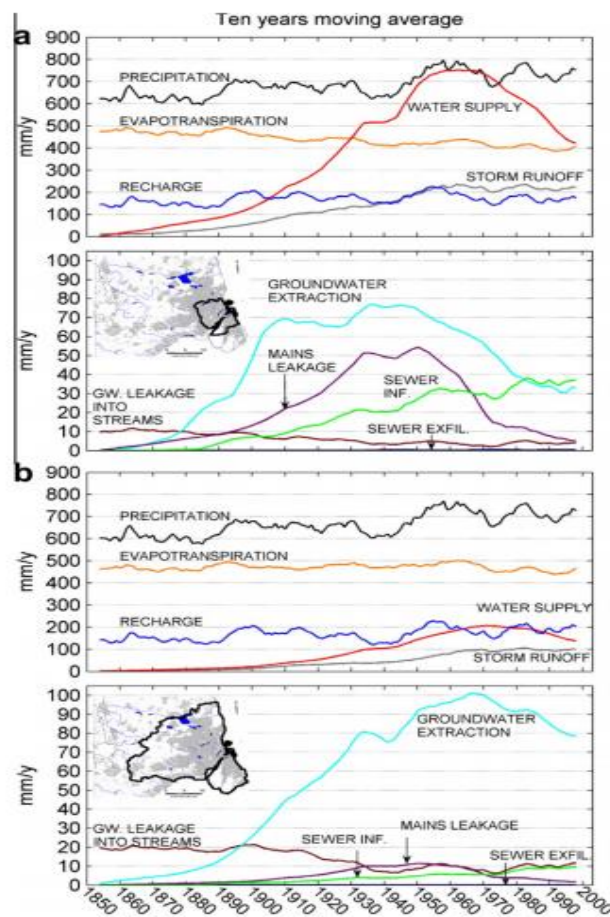

Figure 12 - Storm Water Graphs (Jeppeson et al., 2010)

Then in July 2011, a cloudburst dumped 150 millimeters of rainfall on Copenhagen within three hours (Buley, 2011). Flash flooding crippled the city and left five billion kroner in damage. With the absence of permeable materials throughout most of the city, water was directed to drainage pipes designed by urban planners to drain normal volumes of storm water from the city streets.



Figure 13 – Skybrud 2011 Flooding (Nielsen, 2011)

However, two months' worth of rain fell in three hours, causing the drainage pipes to overflow, flooding streets and buildings. In Amager, the water flowed at such a slow rate towards the Baltic Sea due to its flat topography that it appeared stagnant. The cloudburst, known as "Skybrud 2011", is considered to be the most severe storm to date in Copenhagen (Vestergaard, 2011).

With severe rainstorms hitting Denmark, specifically Copenhagen, at more frequent rates than ever before and costing the city billions of kroner in material damages, the city has decided that the infrastructure needs to adapt. According to the Copenhagen Post, the city has plans to spend over three billion kroner over the next twenty years to improve storm water-related infrastructure (Buley, 2011; CW, 2013; Mufti, 2012). This budget includes the reclamation of green space to aid in absorbing rainfall, and reservoir tunnels to direct storm runoff out of the city and to safe discharge locations. These plans also fall into line with the green space reclamation of the Five Finger Plan, which according to the graphs in Figure 12, has helped with stabilizing the amount of storm runoff that comes as a result of increasing annual rainfall totals. By taking measures like these, the city of Copenhagen is closer to addressing storm water drainage in the face of more frequent and devastating cloudbursts.

2.5.2. The Presence of Air and Noise Pollution in the City

On a global scale, air pollution is a major issue that affects everyone, and has an effect on climate change ("Air Pollution: Smog, Smoke and Pollen," n.d.). On a local scale, air pollution is more important than climate change. As discussed earlier, the transportation sector continues to be the largest contributor to emissions in Copenhagen. Air pollution is a mixture of natural and man-made substances in the air, such as fine particles, produced by burning fossil fuels

(Sciences, 2013).

Cities with high traffic volumes often have high levels of pollution. Copenhagen struggles with pollution, which is problematic for a capital seeking to be carbon-neutral. Pollution cannot be eliminated completely, but it can be reduced to a safe level. Currently Copenhagen is above the threshold value (set in 2010) for emission levels and has been above the specified level of 40 $\mu\text{g}/\text{m}^3$ of NO_2 since 1990. Many health risks can be associated with air pollution. Particulate air pollution is statistically and mechanistically linked to increased cardiovascular disease (Dockery & Stone, 2007). Car traffic can account for 90% of the air pollution in the busiest parts of Copenhagen, such as H.C. Andersens Boulevard (Tørsløv, 2010).

“Noise pollution is the intrusion of unwanted, uncontrollable, and unpredictable sounds, not necessarily loud, into the lives of individuals of reasonable sensitivities” (Bronzaft, 2004). Noise, in most cases, is measured on the scale of decibels. For the average person exposure to 85 dB or higher for more than five hours daily can cause permanent hearing loss². Traffic causes noise pollution as well, but it can vary along a route, and it can also depend on the noise dampening features in the surrounding environment.

| Weighted daily average for traffic noise in Copenhagen near all homes | | | | | |
|---|---------|----------|----------|----------|---------|
| | < 58 dB | 58-63 dB | 63-68 dB | 68-73 dB | > 73 dB |
| Number of homes | 112,827 | 79,432 | 44,713 | 42,435 | 6,673 |
| Proportion of all homes | 39 % | 28 % | 16 % | 15 % | 2 % |

Figure 14 - Table of Traffic in Copenhagen (Tørsløv, 2010)

At 68 dB or higher, 17% of homes in Copenhagen are in the range that is considered a severe nuisance (Tørsløv, 2010). In Copenhagen, the most severely impacted areas are those that are next to major roads or highways. Other than hearing loss, noise pollution can lead to poor mental health due to stress and even impaired learning (Bronzaft, 2004). In Figure 15 below, the areas that are darkest have the highest measured (>75 dB) levels of noise pollution.

² To give a sense scale: a ticking watch is about 20 dB; 45 dB is what it takes to wake a sleeping person; a normal conversation exists at 60 dB; an alarm clock is measured at 80 dB; a lawn mower is at 100 dB; artillery fire is about 140 dB; and an aircraft taking off is at 180 dB ("Decibel Levels of Common Sounds,").

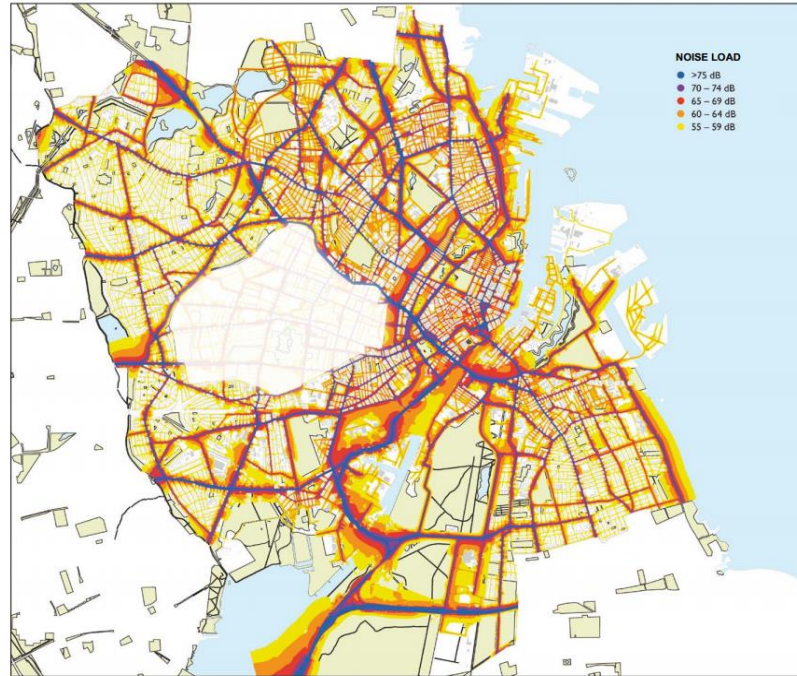

Figure 15 - Map of Traffic in Copenhagen (Tørsløv, 2010)

The above map shows a heat map with levels of noise in Copenhagen. Vehicular traffic is the main source of high pollution levels in Copenhagen. Air pollution is the result of greenhouse gas emissions from vehicles, while noise pollution is the sound disturbances caused by vehicles. The reduction of air and noise pollution would increase the livability of the city. An increase in green space would assist in the reduction of both air and noise pollution.

2.5.3. [The Lack of Green Space](#)



Figure 16 - The Greening of Kastellet Star Fortress, Copenhagen ("Det Grønne København,")

The lack of green space in Copenhagen has been a problem in Copenhagen for over one hundred years. Recently, the city has ruled that there must be a park within a fifteen-minute walking radius regardless of a person's position within the city. These public green spaces will come in the form of pocket parks modeled after New York City's

and in the form of larger parks like Amager Fælled and planned parks on Nordhavn and Refshaleøen ("Det Grønne København," n.d.). There is a certain set of criteria that each park must meet in order for it to meet Copenhagen's quality standards. These include but are not limited to: a variety of experience; vigorous and varied plant life; creative landscape design; areas for play, movement, sport and exercise; meeting points for groups of people; gardens; and public safety considerations ("Det Grønne København," n.d.). The main goal of this set of quality criteria is to make sure that the green spaces are fun and safe places for everyone. This is important because it improves the overall quality of life in the area and increases the livability of the city.

However, one of the main concerns with the Eastern Ring Road proposal is that the construction of it will ruin what is left of Amager Fælled, and simply having the highway and tunnel run through it will damage it as well. As Figure 10 shows, the boring site is located at the northern tip, which will cause destruction of the area due to the placement of the boring equipment. The road put in place to connect the tunnel to the residential area west of Amager Fælled and the extension of a road to connect the tunnel to the E20 highway will destroy the local wildlife's habitat and valuable green space. After the construction is complete, it would take years for Amager Fælled to recover, but the scar of construction would remain and the animals lost would not come back.

The destruction of Amager Fælled's green space is one of the major reasons the Municipality of Copenhagen has not yet approved the E-R (see Figure 10), which contradicts Copenhagen's desire to increase the amount of green space in the city. Adding green space and keeping the current green space intact has health benefits associated with the heart and lungs because the greenery removes harmful carbon dioxide levels from the air. It also acts as a noise barrier, absorbing noise from cars in the surrounding areas. In addition, green space also absorbs rainwater, which in cases of cloudbursts reduces the probability of flooding. To avoid the destruction of Amager Fælled caused by the E-R plan, Copenhagen must examine and seriously consider alternate tunnel routes.

2.6. Conclusion

Intelligent urban planning can resolve many of Copenhagen's problems. The construction of a tunnel similar to the one proposed in "Flood Prevention and Daylighting of Ladegårdsåen"

(2012) would provide a solution to storm water and traffic. The need to reduce traffic in Copenhagen has prompted the development of multiple tunnel proposals. The lack of public and political support for these proposals has given Miljøpunkt Amager the opportunity to evaluate these proposals and suggest alternatives that will benefit the residents of Amager, instead of just central Copenhagen.

3.0 METHODOLOGY

3.1. Introduction

The team developed and compared several possible scenarios for tunnels that will alleviate traffic congestion in Central Copenhagen and on Amager, an island region of southern Copenhagen. The visualizations of the tunnel scenarios will be useful to Miljøpunkt Amager for the promotion of a search for better alternatives to the current tunnel proposals for the area. To accomplish these goals, the team addressed the following objectives:

- To gather information and data on current traffic congestion and patterns along H.C. Andersens Boulevard and other heavily trafficked roads in Copenhagen.
- To gather information pertaining to flood management during major rainfall events and the current storm water drainage infrastructure.
- To collect the general opinion of local politicians and residents on aspects of the tunnel that affects the livability of Amager.
- To provide several route options that will solve storm water and traffic congestion problems on Amager.
- To provide a comparison between possible tunnel scenarios, including the Eastern Ring Road, using effects on urban green space, traffic congestion, and the general livability of Copenhagen.

The remainder of the chapter will provide specifics about the methods implemented to fulfill the objectives and the timeline of the project. Figure 17 displays the goals divided amongst 6 phases and the schedule that the team expected to follow.

| Phase | Phase Description | Details | Week | | | | | | | |
|---------|---|---|------|---|---|---|---|---|---|---|
| | | | 1 | 2 | 3 | 4 | 5 | 6 | 7 | 8 |
| Phase 1 | Situating the Project | Discussion of plans with sponsor | ■ | | | | | | | |
| | | Survey route | ■ | | | | | | | |
| | | Survey possible entrances/exits | ■ | | | | | | | |
| Phase 2 | Gathering Information on Traffic and Flooding | Local traffic expert interviews | | ■ | ■ | | | | | |
| | | Local flood expert interviews and tours of facilities | | ■ | ■ | | | | | |
| Phase 3 | Gathering Information on Public Opinion | Local politician interview | | ■ | ■ | | | | | |
| Phase 4 | Developing a Vision of a New Tunnel | Tunnel rendering | | | ■ | ■ | ■ | ■ | | |
| Phase 5 | Comparing Tunnel Visions | Collation of information about tunnel proposals | | | | | ■ | ■ | | |
| Phase 6 | Deliverables | Primary deliverables | | | | ■ | ■ | ■ | | |
| | | Final deliverables | | | | | | ■ | ■ | ■ |

Figure 17 – Gantt Chart of the Proposed Timeline

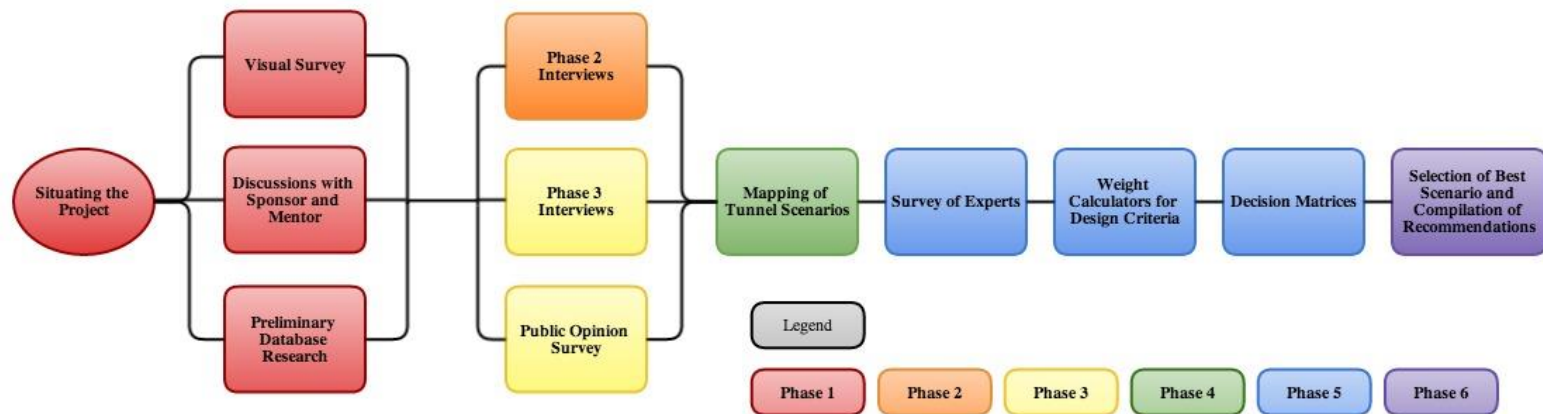

Figure 18 – Methods Flow Chart (reads left to right)

3.2. Phase 1 - Situating the Project

There are many ways that the team could have begun this project, including visiting the areas affected by the motivating problem, surveying the area on maps, or discussing the project with Miljøpunkt Amager. The team chose to use a combination of these methods because they believed that a single method would not be enough to emphasize the various motivations for the project.

The team began by visiting the most congested roads on Amager to gather visual information about the current land development and vehicular congestion during rush hour. Rush hour in Copenhagen is roughly between 7:00 AM and 9:00 AM, and 4:00 PM and 6:00 PM on weekdays (Google Maps, 2014). According to the Google Maps traffic interface; highly trafficked roads in morning rush hour are also highly trafficked in the afternoon rush hour. The team identified H.C. Andersens Boulevard, Amager Boulevard, Amagerbrogade, Artillerivej, and Ørestads Boulevard as the most congested roads on and leading to Amager during rush hours. The group then used maps provided by the web database Københavnerkortet ("The Copenhagen Card", n.d.d) for daily traffic counts along these roads.

The third method of building the foundation for this project was having discussions with the project sponsors. The team met with Lise Nygaard Christensen, a project manager at Miljøpunkt Amager, and Inge Hopps, an intern in urban design with Miljøpunkt Amager, to discuss the project's direction and scope. The main goal of the meeting was to get a firm understanding of the sponsors' expectations for the project. Points for discussion in the meeting were possible routes for the tunnel scenarios, if it should provide access to public transportation, location of underground parking, and possible tunnel exits and entrances.

The team's primary contact in the sponsoring agency was Claus Knudsen, who went on paternity leave soon after their arrival in Copenhagen. Since he was not present for the remainder the project, the group met with him prior to his departure to discuss the state of the project, his expectations for the group, the vision of a tunnel, and the methods for comparing tunnel scenarios. During this meeting, Mr. Knudsen and the team discussed the possibility of a decision matrix for ranking each of the hypothesized tunnel routes developed for this project (discussed in depth later in Section 3.6).

Miljøpunkt Amager employed Anders Jørn Jensen, a consultant for the 2012 WPI IQP

Ladegårdsåen daylighting project, to aid the team in the brainstorming and development of possible tunnel scenarios. The team met with him weekly throughout their time in Copenhagen. He helped select possible tunnel routes and provided professional guidance on the project. In addition, he helped produce educated guesses of the effect each tunnel scenario could have on traffic and the local community.

3.3. Phase 2 - Gathering Information on Traffic and Flooding

In order to understand the problems that affected Copenhagen, the team selected a panel of interviewees that represented several interest groups involved in producing a viable traffic solution for the municipality. This section and Section 3.4 discuss the selection of interviewees. Participants of interviews could deny recording or end their interview at any point. They could opt out of answering specific questions if they wanted to as well. The two interviews during this phase were semi-structured. Appendix A includes the scripted questions, as well as an analysis of each question. The analysis of questions justifies the reason for asking each question. Each interview began with the scripted questions and then discussion transitioned to interesting topics mentioned earlier in the interview. Appendix C contains the contact summary forms, which summarize the relevant information from interviews. Recordings of interviews are available upon request from Lucia Shumaker (contact: lrshumaker@wpi.edu).

During the interviews, interviewees provided material for the development to help develop possible tunnel routes. Both traffic experts that the team contacted could not meet for an interview. The primary contact, Åse Boss Heinrichsen referred the team to Anders Rody Hansen. The interview included in Appendix A was prepared prior to the interview and Anders Rody Hansen agreed to answer questions through email. The team did not receive responses to these questions, and therefore unable to gain access to the desired additional information about traffic frequency on H.C. Andersens Boulevard, Amager Boulevard, Amagerbrogade, Artillerivej, and Ørestads Boulevard.

To understand how Copenhagen manages storm water and flooding, the team met with Nis Fink of HOFOR. HOFOR stands for Hovedstadsområdets Forsyningsselskab, (English: “Greater Copenhagen Utility.”) HOFOR supplies the city with water, wastewater treatment, heating, cooling and maintains wind turbines. HOFOR is the primary water treatment company in Copenhagen and the point of the interview with them was possible future solutions to flooding

dangers. The team's choice of HOFOR also comes from their mission to work for better protection of groundwater, better climate protection, and a CO₂ neutral capital city. The discussion included how Copenhagen currently attempts to control large-scale flooding and how the demand on storm water management will change in the future.

3.4. Phase 3 – Gathering Information on Public Opinion

A crucial step in designing any large urban project is determining the needs and desires of the people it will affect. Due to the team's limited time in Copenhagen, they gathered information on public opinion by reaching out to people in the community who were knowledgeable about general feelings regarding traffic and other aspects of the project. In addition to the key interviews, the team created a public opinion survey to catalogue individual's opinions. The surveys supported the selection of key interviewees as representatives of interest groups and the interviews balanced the limited sample size achieved by the survey. The survey results verified the team's understanding of public opinion surrounding projects similar to the tunnel scenarios analyzed later in this project. The team selected three interviewees to discuss public opinion: Lars Weiss, a local politician; Susanne Rasmussen, an employee for a local political party; and Julie Schack, a Copenhagen resident receiving compensation for disturbances caused by Metro construction.

The team interviewed Lars Weiss, leader of the Social Democrats Municipal Council Group in Copenhagen City Hall, to gain information about the public's views on traffic and the Eastern Ring Road (E-R) proposal, and the public's expected level of receptiveness to alternate tunnel proposals. The team selected Lars Weiss because his job requires that he be well acquainted with the current tunnel proposals that will affect his constituency, Amager. In addition, he is a resident of Amager and was able to speak about the effects a tunnel might have on the local community. The discussion involved the politics around traffic, Copenhagen's plans for supporting population growth, and Amager residents' feelings about short-term inconvenience from construction versus the long-term benefits of traffic diversion.

The group conducted an impromptu interview without a prepared as the team collected a set of renderings of the Eastern Ring Road proposal used in Section 4.04.0. They met with Susanne Rasmussen, the Secretary for Amager Vest Lokaludvalg, and discussed the effect the E-R would have on the community of Amager Vest. The discussion covered topics including the importance

of green space in Amager and the preservation of Amager Fælled. While a political party employs Ms. Rasmussen, she is more involved with the local residents than Lars Weiss and provided a better perspective on people's interests and concerns surrounding the construction of a tunnel.

In addition to meeting a local politician and a politically involved employee, the team interviewed a resident living near a Metro construction site. The interviewee, Julie Schack, was one of the many Copenhagen residents that would receive a settlement payment for the inconvenience the construction inflicted on her life. The team selected Ms. Schack in part because she has a personal connection to the project sponsors (she is a colleague of Ms. Hopps). The objective of meeting with Ms. Schack was to identify residents' outlook on construction in the city and determine the magnitude of the disruption caused by the construction.

3.4.1. Public Opinion Survey

The WPI IQP team wrote and conducted a survey to gather information on public opinion regarding Amager Fælled, traffic congestion, and the large traffic infrastructure projects in Copenhagen. Appendix B contains the survey and details of the reasoning behind each question. The survey protocol offered respondents a choice of completing the survey on paper or verbally while a team member recorded their responses on the form. The project team conducted the survey on Friday, April 2 between 2 PM and 3 PM and on Saturday April 3 between 1 PM and 3 PM at Amagerbro Torv. The project team selected Amagerbro Torv because it is a public square located next to the Amager Centret shopping center and the Amagerbro Metro station. People arrive at the shopping center by car, bike, public transit, or on foot. The team gathered 35 responses to form a proper representation of the various form of transportation. Interest in transport infrastructure projects would likely vary based on likelihood of use, which was associated with personal preference of transportation method and residence location.

3.5. Phase 4 - Developing a Vision of a New Tunnel

3.5.1. Weekly Meetings with Anders Jørn Jensen

Miljøpunkt Amager employed Anders Jørn Jensen, a consultant for the 2012 WPI IQP, "Flood Prevention and Daylighting of the Ladegårdsåen" (2012). The team for Miljøpunkt Amager met him during the first advisor-sponsor meeting on Tuesday March 18, where he presented information about the Eastern Ring Road and Ladegårdsåen Tunnel project. The team met with

Mr. Jensen weekly to discuss the project's progress, new information that he came prepared with, and any questions. These meetings provided a basis for work and acted as a springboard for the upcoming week's work.

3.5.2. Processed Information Regarding Existing Tunnel Projects

Each week after meeting with Mr. Jensen, it was crucial to analyze the information he provided, determine its meaning, and understand its relevance to the project.

Mr. Jensen gave the team a report titled "Østlig Ringvej København" (Transportministeriet, 2013), which is referred to hereafter as the Rambøll report. This report included the most crucial information for the project's early stages because it details the bored cross section of the Eastern Ring Road and other relevant information pertaining to the proposal. From this cross section, the team composed a sketch of the approximate area of the four possible water storage compartments in the tunnel. The product of the area of these sections and the length a tunnel was an estimate of the water storage capacity. The result of this calculation determined if a tunnel had the storage capacity to contain the water accumulated in cloudburst situations. Another central topic for discussion early on was how to plan a route that avoided surfacing in Amager Fælled, unlike the E-R. Since Miljøpunkt Amager is an environmental points organization, surfacing in Amager Fælled runs counter to the organizations values of preserving and enhancing the environment.

3.5.3. Processed Information on Copenhagen's Present and Future Building Zones

In order to design a route that avoided surfacing in Amager Fælled, Mr. Jensen suggested that the team focus on understanding the E-R's southwest entrance/exit location. The location is at an interchange that connects Artillerivej, Vejlands Allé, and the E20, capable of transferring a high quantity of traffic between the three. The surfacing of the tunnel would destroy Amager Fælled's green space, so the team gathered information about present and future building zones in Copenhagen using the Copenhagen Card online database. The database includes current and planned construction zones, housing plans, and retail properties. From the information provided on the Copenhagen Card website, the team identified locations for an alternative exit and available space for construction.

3.5.4. Conducted Additional Research on the Implementation of a Congestion Ring

At Mr. Jensen's request, the team explored the implementation of a congestion ring with the

purpose of keeping cars out of Central Copenhagen. If commuters pay tolls for entering the city center, the cost would discourage them from driving into or through the area and instead encourage the use of public transportation. To gain a more complete understanding of how congestion rings work, the team researched London's successful congestion ring launched in 2003. This research made it possible to identify where the implementation of tolls would be most appropriate.

3.5.5. Identified Plausible Tunnel Routes

After analyzing data on the E-R and Ladegårdsåen project, exploring possible entrance/exit locations, understanding Copenhagen's building zones, and researching congestion rings, the team developed eight preliminary tunnel routes, each with some similarities to the E-R or Ladegårdsåen projects. The team avoided use of the eastern side of Amager due to its high population density and focused on scenarios that directed traffic to the western side of the island. Mr. Jensen believed that completing the eastern portion of a ring road (extending the O2) was important because future citizens of Copenhagen's harbor developments (Refshaleøen and Nordhavn) would have limited access to the city (each has one road to and from the mainland).

Using this information, the team created a modified set of seven tunnel scenarios. The newer scenarios included the E-R, Ladegårdsåen tunnel plus an extension, "Y" scenarios that combine the E-R and Ladegårdsåen tunnel, and modified scenarios of each that have exits near Field's shopping center in Amager Vest. These scenarios satisfied Mr. Jensen's requirements.

3.6. Phase 5 – Evaluating and Comparing Tunnel Scenarios

3.6.1. The Process for Evaluating Tunnel Scenarios

In order to evaluate each tunnel scenario, the team developed a series of charts and matrices to analyze design characteristics including cost, accessibility, floodwater management, reduced number of cars, reduced amount of harmful pollutants, and the preservation of green space. Each of these categories played an important role in determining a tunnel proposal's ability to pass through Copenhagen's government and how it could serve the community. The method, detailed below (Figure 19), took the opinions of each expert interviewed and placed them in a pairwise comparison chart. Head-to-head matchups determined the importance of each category. Each category was then placed in a decision matrix with a point value based on its importance, out of a 100-point maximum scale. After determining the weighted point values, a series of tables used

the data gathered for each category and created tunnel scenario ranks relative to each other. The team then calculated the percentage of points per category that each scenario deserved and inputted them into the decision matrix. The team used Microsoft Excel to generate all tables included in the following sections. The program was used for each formula and calculated value included in the following tables.

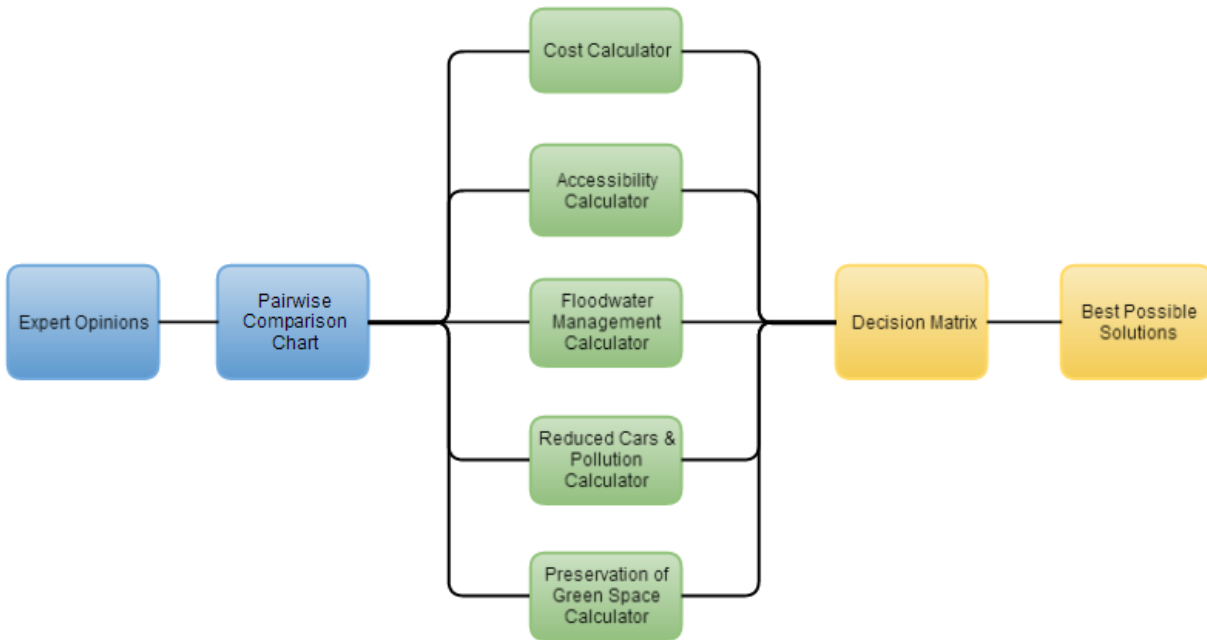

Figure 19 – Flow Chart Depicting the Process of Evaluating Amager Visioning's Tunnel Scenarios

3.6.2. Assigning Weights using a Pairwise Comparison Chart

For ease of communication, the team developed a pairwise comparison chart with evaluation categories that summarize tunnel characteristics. The pairwise comparison chart lists the evaluation categories in a column and compares them to the same list of categories listed horizontally. If the row category was more important than the column category, the cell earned a value of one. If not, the cell earned a value of zero. In cells that have the same row and column labels, a comparison was impossible, and the cell earned no value. Dashes (-) denoted no value earned by the cell. Using Table 1 as an example, the matrix posed the question, “is cost more important than accessibility?” for the second cell in row 1. If it was more important, the evaluator placed a ‘1’ in the box. If it was less important than accessibility, then the evaluator placed a ‘0’ in the box. The evaluator followed the same procedure for the remaining boxes in the “cost” row and each subsequent rows. This method of using head-to-head matchups

determined the importance of each category with respect to the others.

| Category | Cost | Accessibility | Floodwater Management | Reduced # of Surface Cars | Reduced Air and Noise Pollution | Preservation of Green Space | Total |
|---------------------------------|------|---------------|-----------------------|---------------------------|---------------------------------|-----------------------------|-------|
| Cost | - | | | | | | 1 |
| Accessibility | | - | | | | | 1 |
| Floodwater Management | | | - | | | | 1 |
| Reduced # of Surface Cars | | | | - | | | 1 |
| Reduced Air and Noise Pollution | | | | | - | | 1 |
| Preservation of Green Space | | | | | | - | 1 |

Table 1 – Empty Pairwise Comparison Chart

Once the table was complete, the evaluator summed the points from each row and entered the sum into the “Total” column. This number, divided by the total number of points accumulated, gave the weight of each category (see equation above Table 2). The weight, multiplied by 100, gave the weight percentage for the corresponding category. This weight percentage was out of 100 total points. (Table 2 shows the entry field for each step)

$$(\text{Weight percentage}) = \left(\frac{\text{Category Point Sum}}{\text{Total Points}} \right) * 100$$

| Categories | Weight | Point Total | Weighted Percentage |
|--|--------|-------------|---------------------|
| <i>Cost</i> | | | |
| <i>Accessibility</i> | | | |
| <i>Floodwater Management</i> | | | |
| <i>Reduced # of Surface Cars</i> | | | |
| <i>Reduced Air and Noise Pollution</i> | | | |
| <i>Preservation of Green Space</i> | | | |

Table 2 – Empty Weighted Percentage Calculator

3.6.3. [How the Expert Opinions Influence the Decision Matrix](#)

In an effort to incorporate each of the interviewees’ opinions on the traffic tunnel scenarios, each expert received an electronic form/survey that asked them to rank the categories in the decision

matrix (electronic form shown Figure 20). The team also asked the project's technical mentor, Anders Jensen, and primary sponsor, Claus Knudsen, to respond to the survey. The ranks ranged from 0 to 6, with 6 being the highest importance. No category could share the same non-zero rank as another category because the evaluator inputted the results directly into the pairwise comparison chart.

This method of incorporating expert opinions into the decision matrix would generate seven pairwise comparison charts and seven decision matrices³, each one with category weights that reflected where respondents placed importance. The team received three responses to the survey (Nis Fink, Claus Knudsen, and Anders Jensen). These responses are included in the Data and Analysis chapter.

From this, the team evaluated the possible reasons for why each expert ranked the categories as they had and discussed the results of each decision matrix. Since there were only three decision matrices, it was unlikely that patterns would emerge. Due to this, the team was unable to discuss trends in tunnel rankings that would help in the overall discussion of a traffic tunnel in Copenhagen.

³A decision matrix for Anders Jensen (consultant), Claus Knudsen (Miljøpunkt Amager's center director), Lars Weiss (politician from Amager), Anders Rody Hansen (Københavns Kommune Center for Traffic), Nis Fink (HOFOR Greater Copenhagen Water Utility), Julie Schack (resident affected by metro construction), and Susanne Rasmussen (Amager Vest Lokaludvalg).

| | 0 (Should not be considered.) | 1 | 2 | 3 | 4 | 5 | 6 |
|---|-------------------------------|-----------------------|-----------------------|-----------------------|-----------------------|-----------------------|-----------------------|
| Tunnel construction cost | <input type="radio"/> | <input type="radio"/> | <input type="radio"/> | <input type="radio"/> | <input type="radio"/> | <input type="radio"/> | <input type="radio"/> |
| Accessibility of tunnel entrances | <input type="radio"/> | <input type="radio"/> | <input type="radio"/> | <input type="radio"/> | <input type="radio"/> | <input type="radio"/> | <input type="radio"/> |
| Inclusion of storm water management infrastructure in tunnel design | <input type="radio"/> | <input type="radio"/> | <input type="radio"/> | <input type="radio"/> | <input type="radio"/> | <input type="radio"/> | <input type="radio"/> |
| Reduction of car traffic on the surface in Central Copenhagen and on northern Amager | <input type="radio"/> | <input type="radio"/> | <input type="radio"/> | <input type="radio"/> | <input type="radio"/> | <input type="radio"/> | <input type="radio"/> |
| Reduction of air and noise pollution from cars in Central Copenhagen and on northern Amager | <input type="radio"/> | <input type="radio"/> | <input type="radio"/> | <input type="radio"/> | <input type="radio"/> | <input type="radio"/> | <input type="radio"/> |
| Preservation of park space and green spaces | <input type="radio"/> | <input type="radio"/> | <input type="radio"/> | <input type="radio"/> | <input type="radio"/> | <input type="radio"/> | <input type="radio"/> |

Figure 20 – Electronic Form for Ranking the Decision Matrix Categories for Order of Importance

3.6.4. Estimating the Cost of a Tunnel Scenario

| Direct Costs | Scenario 0 | Scenario 1 | Scenario 2 | Scenario 3 | Scenario 4 | Scenario 5 | Scenario 6 |
|-----------------------------|--------------|--------------|--------------|--------------|--------------|--------------|--------------|
| Length (km) | | | | | | | |
| Price (2Billion/km) | DKK - | DKK - | DKK - | DKK - | DKK - | DKK - | DKK - |
| Number of Entrances/Exits | | | | | | | |
| Price | DKK - | DKK - | DKK - | DKK - | DKK - | DKK - | DKK - |
| Number of Parking Locations | | | | | | | |
| Price | DKK - | DKK - | DKK - | DKK - | DKK - | DKK - | DKK - |
| Total | DKK - | DKK - | DKK - | DKK - | DKK - | DKK - | DKK - |

Table 3 – Empty Table for Determining the Direct Cost of Each Tunnel Scenario

The tunnel scenarios' direct costs are the costs that the public and politicians see if a project is

proposed. The categories (length, number of entrances/exits, and number of parking locations) play a pivotal role in the final cost of building a tunnel because they are the primary features that make up the tunnel. Aside from labor and material costs, they are the majority of a tunnel's cost. It was important to look at these direct costs because the cost of the Eastern Ring Road and previous tunnel proposals was difficult for City Hall and the taxpayers to agree upon, which led to more negotiating and less progress.

The spreadsheet above (see Table 3) calculated the direct costs using information provided by Anders Jensen. The calculations for the direct costs were as follows:

Cost of Operating a Boring Machine

The cost of operating a boring machine is approximately two billion DKK per kilometer. This cost was multiplied by the length of the tunnel to calculate the cost of boring.

$$(Cost\ of\ Boring\ a\ Tunnel) = (2\ Billion\ DKK) \times (Length\ of\ the\ Tunnel)$$

Cost of building Entrance/Exit Locations

The cost of building entrances and exits is approximately 50,000 to 100,000 DKK (Tunnel under Åboulevard, 2013). Each ramp in addition to the main tunnel entrances/exits costs an average of sixty-eight million DKK. Thus, after taking this into account and by finding the median of the fifty to one hundred thousand DKK, the cost used to calculate the cost of the entrance/exit locations was 75,000 DKK.

$$\begin{aligned} &(\text{Total Entrance/ Exit Construction Cost Approximation}) \\ &= (75,000\ DKK\ per\ Location) \times (\text{Number of Locations}) \end{aligned}$$

The indirect costs of a tunnel scenario are costs that do not appear on a proposal's price tag. They are side effects of the tunnel's design, which can cost the taxpayers more long after a project is completed. For the tunnel proposals, the primary indirect cost expected that the tunnel would prevent was material damages due to future flooding in Copenhagen. A numerical representation of the indirect costs was beyond the team's capabilities due to the team's background, knowledge, and time in Copenhagen. Instead, the Data and Analysis chapter includes a qualitative discussion of possible additional costs.

Table 3 calculated the percentage of "Cost" points each scenario earned in the decision matrix by ranking them in order of least to most expensive (one being the cheapest and seven being the

most expensive). This number, in order to prevent any scenario from earning zero points, was subtracted from eight (the number of scenarios plus one) and divided by seven (the number of scenarios). The method ensured that no scenario could earn zero points, and the cheapest scenario earned the most points.

$$(\text{Percentage}) = \frac{(\text{Number of Scenarios} + 1) - (\text{Scenario Rank Value})}{\text{Number of Scenarios}}$$

The cost of building a traffic tunnel in Copenhagen is one of the primary factors in its ability to receive government funding. The direct cost of the construction project is the final price tag presented to the citizens and the city in proposals. Factors like the length of the tunnel and the number of exits/entrances are the main contributors to the direct cost of the project because they determine the distance the boring machines will tunnel, the timetable for the project's completion, and the extent of how much of the city needs to be torn up for the exits⁴.

The indirect costs, like possible effects on floodwater, are costs that may arise from future complications. If the local road infrastructure cannot handle the increased traffic load near the tunnel entrances/exits, additional work would be required in the future to support the increasing traffic. Both direct and indirect costs are important factors in the overall cost of a tunnel in Copenhagen.

⁴At the tunnel entrance/exit sites, the construction method will switch from boring to cut and cover. This means that more entrances and exits will require more digging in the city and digging equipment at various locations along the route.

3.6.5. Projecting a Tunnel's Accessibility

| Accessibility | | | | | | | |
|--|------------|------------|------------|------------|------------|------------|------------|
| Name | Scenario 0 | Scenario 1 | Scenario 2 | Scenario 3 | Scenario 4 | Scenario 5 | Scenario 6 |
| Number of Entrances/Exits | | | | | | | |
| Rank | | | | | | | |
| North Entrance Location 1 | | | | | | | |
| Number of Cars expected to pass through daily | | | | | | | |
| North Entrance Location 2 | | | | | | | |
| Number of Cars expected to pass through daily | | | | | | | |
| Rank | | | | | | | |
| South Entrance Location | | | | | | | |
| Number of Cars expected to pass through daily | | | | | | | |
| Rank | | | | | | | |
| Number of Cars expected to pass through Nordhavn daily in 2032 | | | | | | | |
| Rank | | | | | | | |
| Combined Accessibility Ranking | | | | | | | |
| Percentage | | | | | | | |

Table 4 – Empty Table for Determining the Accessibility of Each Tunnel Scenario

The accessibility of a tunnel was an important measure of the tunnel scenario's worth as an investment. A worthwhile transit infrastructure project must service as many people as possible. In order to calculate the tunnel's relative accessibility, Table 4 ranked the scenarios by how many cars would travel through the northern and southern entrances on a daily basis in the year 2032. Anders Jensen provided the numbers for each location in previous research completed for Miljøpunkt Nørrebro (Table 24). The team selected the year 2032 for the prediction models because it is 20 years after the date of the initial prediction provided. Excel then calculated the average accessibility ranking of each scenario and the weighted percentage of "Accessibility" points each one deserved. This process used the same method described in Section 3.6.4.

$$(\text{Percentage}) = \frac{(\text{Number of Scenarios} + 1) - (\text{Combined Accessibility Ranking})}{\text{Number of Scenarios}}$$

3.6.6. Estimating a Tunnel's Floodwater Management Capabilities

| Floodwater Management | | | | | | | |
|--|-------------------|-------------------|-------------------|-------------------|----------------------|-------------------|-------------------|
| Name | Scenario 0 | Scenario 1 | Scenario 2 | Scenario 3 | Scenario 4 | Scenario 5 | Scenario 6 |
| <i>Length (km)</i> | | | | | | | |
| <i>Total Water Storage Capacity (cubic meters)</i> | | | | | | | |
| <i>Rank</i> | | | | | | | |
| <i>*Note: The cross section detailed by Ramboll is approximately</i> | | | | <i>32.0</i> | <i>square meters</i> | | |
| <i>Water Storage in Flood-Prone Areas (cubic meters)</i> | | | | | | | |
| <i>Rank</i> | | | | | | | |
| Combined Floodwater Management Rank | | | | | | | |
| Percentage | | | | | | | |

Table 5 – Empty Table for Determining Each Scenario's Floodwater Management Capabilities

Each scenario received a rank value for its ability to help manage storm water. A rank value of one denotes that the scenario can contain the largest volume of water, while a rank value of seven corresponds to the smallest volume of water contained. The team determined the rank by finding the volume of each tunnel's excess space (from the cross section of a single, two-traffic-deck tunnel provided by the Transportministeriet). The team used the SolidWorks cross section mentioned previously to estimate that the excess space in the tunnel (measured about 32 square meters). The product of the length of the tunnel and 32 square meter cross section is the maximum fluid volume the tunnel can hold.

However, tunnel length is not a complete representation of the scenario's ability to manage storm water. Aspects of flood management that the team could not calculate in this numerical comparison include the tunnel's route as it related to flood-prone locations on the surface or the length of the tunnel submerged under the harbor. This rank comparison provided a preliminary estimate of each tunnel's use in flood management, though all of them have a theoretical capacity that exceeds rainfall estimates for future storms. Additionally, this table cannot reflect the cost each scenario might add if it included a floodwater management system. (Transportministeriet, 2013)

3.6.7. Estimating the Number of Cars Reduced from Surface Roads

| Cars & Pollution | | | | | | | |
|---|-------------------|-------------------|-------------------|-------------------|-------------------|-------------------|-------------------|
| Name | Scenario 0 | Scenario 1 | Scenario 2 | Scenario 3 | Scenario 4 | Scenario 5 | Scenario 6 |
| <i>Number of Cars on Road on H.C. Andersens Blvd. in 2012</i> | | | 76300 | | | | |
| <i>Length of H.C. Andersens Boulevard (km)</i> | | | 1.30 | | | | |
| <i>Number of Cars Reduced by 2032</i> | | | | | | | |
| <i>Rank</i> | | | | | | | |
| <i>Number of Cars on Langbro Bridge in 2012</i> | | 99800 | | | | | |
| <i>Number of Cars Reduced by 2032</i> | | | | | | | |
| <i>Rank</i> | | | | | | | |
| <i>Number of Cars Placed Underground by North Entrance 1</i> | | | | | | | |
| <i>Number of Cars Placed Underground by North Entrance 2</i> | | | | | | | |
| <i>Number of Cars Placed Underground by South Entrance</i> | | | | | | | |
| <i>Total # of Cars Passing thru Entrance/Exit Locations</i> | | | | | | | |
| <i>Rank</i> | | | | | | | |
| Average Overall Rank | | | | | | | |
| Overall Weighted Percentage | | | | | | | |

Table 6 – Empty Table for Determining the Number of Cars Reduced from Surface Roads

Table 6 shows how the number of cars removed or added by each scenario to critical points in the city was calculated. As previously stated, predictions of car numbers came from previous research completed by Anders Jensen for Miljøpunkt Nørrebro (Table 24). Scenarios were given ranks for individual locations, which were then averaged. A rank value of seven indicated that the scenario has the least potential to reduce the number of cars on surface roads. A rank value of one corresponded to the scenario that had the greatest potential for traffic reduction. Since traffic congestion in Copenhagen was the primary motivating factor for this project, the conclusions drawn from the results of this table were very important. Though the project team compared each scenario using the other design criteria as well, the conclusions drawn from this table held precedence to other criteria.

3.6.8. Calculating the Amount of Preserved Green Space

| Preservation of Green Space | | | | | | | |
|--|------------|------------|------------|------------|------------|------------|------------|
| Name | Scenario 0 | Scenario 1 | Scenario 2 | Scenario 3 | Scenario 4 | Scenario 5 | Scenario 6 |
| Number of Green Spaces Affected | | | | | | | |
| Rank | | | | | | | |
| Total Green Space Area Affected (square Rank | | | | | | | |
| Rank | | | | | | | |
| Combined Rank | | | | | | | |
| Percentage | | | | | | | |

Table 7 – Empty Table for Determining Each Scenario’s Amount of Preserved Green Space

The team calculated the area of green space affected by cut and cover and entrance/exit construction using the area tool on the Geocortex Viewer for Silverlight on the Danmarks Miljøportal website. Figure 21 and Figure 22 show examples of the area calculations.



Figure 21 – Area Disturbed by Creation of Scenarios 1, 3, & 5



Figure 22 – Area Disturbed by Creation of Scenarios 1,2,5, & 6

Scenarios expected to disturb more total area of green space received higher ranks than scenarios expected to disturb smaller total areas. The number of affected green spaces reflected the number of cut and cover sections and entrances/exits in each scenario. The scenario with the fewest number of affected green spaces was assigned a rank of 0, while the scenario with the highest number of affected green spaces was assigned a rank of 6. Table 7 displays the table used to collect data for this section. The two ranks were averaged to give the “Combined Rank” (Table 7) and these ranks were used to calculate the weighted percentage for each scenario.

The scenario with the lowest combined rank preserves the most green space. The team only considered the area needed for the construction of a tunnel. Other additional traffic infrastructure-related construction or widening of roads needed in the future might reduce the amount of green space as well. The numerical comparison did not include this because it was beyond the scope of the project. Since Copenhagen hopes to be a “green city” and many people can benefit from these recreation areas, the preservation of green space is important. An ideal tunnel scenario would not reduce the city’s green space while reducing cars and being as cheap as possible.

3.6.9. [Evaluating the Tunnel Scenarios using a Decision Matrix](#)

| Categories | Calculated Weights | Scenario 0 | Scenario 1 | Scenario 2 | Scenario 3 | Scenario 4 | Scenario 5 | Scenario 6 |
|--|--------------------|------------|------------|------------|------------|------------|------------|------------|
| <i>Cost</i> | | | | | | | | |
| <i>Accessibility</i> | | | | | | | | |
| <i>Floodwater Management</i> | | | | | | | | |
| <i>Reduced # of Surface Cars</i> | | | | | | | | |
| <i>Reduced Air and Noise Pollution</i> | | | | | | | | |
| <i>Preservation of Green Space</i> | | | | | | | | |
| Total | | | | | | | | |

Table 8 – Empty Table for Determining Each Tunnel Scenario's weight

After putting each interviewee’s responses from the team’s design criteria ranking survey into the pairwise comparison chart, his or her weighting of each criteria was determined and used in a decision matrix similar to Table 8. After calculation of the weights and conversion into point form (Shown in Table 8), they were placed in the “Calculated Weights” column of the decision matrix. The bottom row, labeled “Total”, shows the sums of the scenarios’ scores. The calculated weights were the total number of points a tunnel scenario could earn for each category. The scenario that received the highest amount of total points was considered the interviewee’s preferred scenario.

3.6.10. [Amager Visioning’s Decision Matrix](#)

The team created a pairwise comparison as a summary of the conclusions they came to over the course of this project. The process converted the results of the pairwise comparison into weights using the same method as above. The decision matrix then evaluated the team’s ranking and produced rankings for each scenario.

The weights assigned to each category reflected the team’s views after living in the Copenhagen for eight weeks, interviewing local experts, talking to local residents, and working with the sponsoring agency (Miljøpunkt Amager). This is important because the team is aware that each expert interviewed may have had an agenda that influenced his or her opinions on the topic (of building a traffic tunnel in Copenhagen). However, as outsiders to the community whose only experience with the topic and city are through research and an eight-week stay, they felt that the decision matrix served as an impartial summary of the project.

The team used the rankings of the tunnel scenarios as both a summary of the relative worth of the scenarios and a method of selecting which scenario they suggested that the Municipality of Copenhagen or interested groups should pursue for future development.

3.7. Phase 6 – Deliverables

The final deliverables for this project consisted of:

- Maps detailing possible routes and explanations of each scenario's benefits and drawbacks
- Interviews about traffic, flooding and public opinion (Audio recordings are available upon request from Lucia Shumaker, lrshumaker@wpi.edu.)
- Cross sectional views of a possible tunnel design based on Rambøll's designs for the Eastern Ring Road (Transportministeriet, 2013)
- Pairwise comparisons and personalized decision matrices reflecting each interviewee's point of view on the relative importance of the tunnel design criteria
- A pairwise comparison and decision matrix created by the project team as a summary of the total findings of this project.

3.8. Conclusion

This project utilized the methods detailed in this chapter. The selection of the methods was based on suggestions from the project sponsors and experts interviewed. These included the development of seven tunnel scenarios with visual aids and a ranking system used to evaluate the tunnels scenarios. The team also assessed the implementation of tolls or a congestion ring on surface roads in Copenhagen. Miljøpunkt Amager and other organizations can use the final form of the project as a basis for discussions regarding the design and implementation of subsequent tunnel proposals.

4.0 DATA & ANALYSIS

This chapter illustrates the data collected during the Methodology. The chapter goes into depth on the interviews performed with several specialized people, each bringing different information to the project. Additionally, this chapter explains the maps and data collected throughout interviews and discussion with experts. An analysis of the survey results provides a demographic overview of the participants. Further research done on tunnel construction and toll usage concerning overall tunnel design is included in this section. The report illustrates the decision matrix weights and the results of the specialized pairwise comparisons that each interview participant filled out. An in depth discussion of seven different tunnel scenarios is provided with exit/entrance location, traffic flow understanding, and reasoning for tunnel route selection. Finally, the final decision matrix illustrates a comparison of the tunnels.

4.1. Interviews

The WPI project team interviewed five members of the Copenhagen community in order to get a better understanding of different areas of focus in Copenhagen. In order to become more aware of the current state of traffic issues, floodwater management, and public opinion in Copenhagen based on first-hand knowledge, the team selected a local resident, an employee of the water management facility in Copenhagen and three members that work with the government to interview that would each bring different perspectives to the project. The interviews addressed construction in daily life, water management, political opinion of a tunnel, and public opinion of a tunnel.

4.1.1. [Julie Schack – Resident near Metro Construction](#)

The interview with Julie Schack concentrated on the effects that the Metro construction has had on her daily life. Ms. Schack lived in Østerbro in close vicinity to one of the Metro construction zones. She decided to move into her current living space while construction was already happening, but did not believe that it would be as bad as it is. She understood the hours of operation to be from 6:00 AM to 6:00 PM. The construction times extended to 10:00 at night causing a change in the interviewee's daily life style. She woke to construction and went to bed at night while the construction continued. Not only was there noise, but also on occasion the construction would cause vibrations in her apartment, making the construction bothersome for her the entire time that she lived there.

In an attempt to resolve the issue of disturbing residents near the Metro, the Metro Company provided 10,000 Danish kroner to each resident living in Ms. Schack's building. Originally, the apartment received the money as if there was one apartment, which would result in less money for each resident. Near another construction site in Nørrebro, a friend of Ms. Schack's received 20,000 Danish kroner, even though they did not live as close to the construction as Ms. Schack, and there were also fewer residents in this friend's apartment. The Metro Company did not provide residents technical reasoning for the level of compensation they should receive compared to other residents.

When asked about future construction, Ms. Schack responded that it would bother her, and surely many more people. It is both noisy and ugly, according to Ms. Schack, and there are green barrier walls up all over the city. Ms. Schack, as a student studying urban planning, appreciates the improvements the construction will bring to the city. However, not everyone will benefit from the construction. The current Metro construction near her home will not benefit her, primarily because she mainly travels by bicycle. Furthermore, the construction is not for the creation of a Metro stop, but instead just a site to put in a boring machine. Whether the construction benefits people or not, it becomes a hassle having so much construction in the city.

The team asked Ms. Schack, as a resident affected by the construction, to rank aspects of a tunnel design. Her ranking would have created a pairwise comparison specific to a resident affected by tunnel construction, but we did not receive her response to the survey. Hence, there is no pairwise comparison included to represent the interests of people currently living near construction.

[4.1.2. Nis Fink – HOFOR Water Management Representative](#)

To address flood management systems in Copenhagen, the team talked to Nis Fink of HOFOR, the water management company for all of Copenhagen. The purpose of this interview was to determine whether a tunnel incorporating flood management technologies would reduce flooding concerns and whether there were any plans in place for large storm occasions. The WPI project team was aware that the cloudburst of 2011 caused sufficient distress and assumed that future preparation for storms would be a point to discuss with HOFOR.

Since the cloudburst of 2011, HOFOR has focused on being capable of containing the damage that another storm of its magnitude would cause. Cloudburst Management Plan 2012, according

to Mr. Fink, is the basis for current flood management in Copenhagen. In order to increase the preparedness of the city for future cloudbursts, there are two options. The first option is to tear up the streets of Copenhagen and put in a larger sewer system that will contain more water. The second option is to prevent water from ever getting into the sewers. The second option is a more viable option for HOFOR. Creating rain gardens and the use of permeable surfaces would decrease the amount of water that enters the sewers. However, this is inadequate when a cloudburst occurs. In the times of cloudbursts there needs to be a way to store large amounts of water in a short amount of time. The municipality permits HOFOR, in times of massive rainfall, to dump diluted water into the harbor, and, in the case of a ten-year storm, allow the sewers to overflow. Something done now will prepare Copenhagen for the future. Currently HOFOR believes it is capable of handling a ten-year storm, but in 100 years, a ten-year storm will have evolved and may produce more rainfall and is therefore less manageable with the current infrastructure. Suggestions made by Mr. Fink include increasing the volume capabilities of The Lakes in Copenhagen, placing drainage tunnels in large flooding zones, and creating surface level solutions, such as rain gardens.

When asked about the Ladegårdsåen project, Mr. Fink was aware of both the plans to daylight the piped canal and the traffic tunnel that would be created in place of the pipe. The canal would not help during major rainfall events because it is too small, and Ladegårdsåen project would primarily solve traffic problem. The six to eight billion Danish kroner plan will not help prevent flooding as much as other plans that HOFOR has in mind that are estimated to cost much less than the tunnel. A tunnel, according to Mr. Fink, is not the answer to flooding in any neighborhood in Copenhagen. After looking at a flood map for Amager, (Figure 54 as seen in Section 4.10.2.) Mr. Fink identified a wide range of areas throughout Amager that had flooding problems. Moreover, with an overall topographical difference of 7.5 meters, there is no path for the water to drain naturally because Amager is so flat. The creation of a tunnel that would effectively manage storm water in Amager was an unlikely possibility according to Mr. Fink because of the topography of Amager and the fact that HOFOR could do the same with less expensive plans.

After the completion of the interview, the team asked Mr. Fink to rank aspects of a tunnel design. He ranked tunnel construction cost the highest, reduction of traffic second highest, and then reduction of air and noise pollution. Following that, he ranked inclusion of storm water, then

preservation of green space as second lowest, and accessibility as the least important.

4.1.3. Susanne Rasmussen – Secretary of Amager West Local Committee

Susanne Rasmussen is the Secretary of the West Amager Local Committee (Amager Vest Lokaludvalg) and she agreed to meet with us to discuss Amager Fælled and the public's opinion on the Eastern Ring Road proposal. The Local Committee of Amager West works closely with the residents of West Amager and is a good judge of the people's opinion. Everything that the Local Committee does is in consideration of the people. Amager Fælled is in West Amager and is therefore part of the people's concern. Ms. Rasmussen has been working closely with the E-R proposal because so many of the local residents are concerned about its impact on them. One of the issues that arose in many debates, says Ms. Rasmussen, was an "us vs. them" conflict. Too often, there is disagreement between the aspirations of Copenhagen and the desires of Amager's citizens. This conflict is at the heart of the Eastern Ring Road debate.

The E-R is in the discussion phase and is not close to a final decision. The prospective route cuts through Amager Fælled and destroys a large strip of the natural green space. The people of West Amager, according to Ms. Rasmussen, do not want to see this natural space destroyed and therefore do not want the E-R. The Local Committee of West Amager took a group of approximately 150 people, including a few local politicians, out on a walk through Amager Fælled to illustrate the value of the Fælled. In addition, Ms. Rasmussen often hears concerns from people living in the nearby neighborhoods that do not want to be disturbed by construction or an increase of motor vehicle traffic in the area. Amager does not consist of a specific demographic, so the construction in Amager Fælled would upset a broad range of people, both rich and poor.

When asked about the possibility of extending the Ladegårdsåen tunnel, Ms. Rasmussen responded that a tunnel may encourage more people to drive, and putting it underground may just hide the problem from the public's eye. She also fears that people from the city do not use the Fælled as much as they can because its identity is not well defined and it is a natural area. If the Fælled was more accessible it may allow people to use it more often, which would provide West Amager a stronger defense against the surfacing of the tunnel in Amager Fælled.

After discussion with Ms. Rasmussen, the team asked her to provide a ranking of tunnel aspects based on the public opinion. She did not submit a response and therefore the project team could

not generate a pairwise comparison for her point of view.

4.1.4. Lars Weiss – Leader of Social Democrats in Copenhagen City Hall

Lars Weiss, Leader of the Social Democrats Municipal Council Group in City Hall, agreed to meet with the WPI project team to provide us with an understanding of the political and public stances on the Eastern Ring Road and the Ladegårdsåen Project. A majority of city hall, including Lars Weiss, is in favor of the E-R. He believes that the E-R is a good idea, but it is also extremely expensive. Part of the reason why the municipality called it a ring road instead of a harbor tunnel was to gain state funding for the project.

Lars Weiss believes that there is a traffic problem in Amager. The motorway from Southern Zealand ends in Amager, and the roads connecting this exit to the city center are incapable of handling an increase in traffic. If the expected population and traffic increase occurs then better infrastructure is required. The city ring, O2 highway, runs through the middle of the city and faces the same capacity problem. By creating the E-R, cars bypass the busy center and are capable of crossing the city with ease. The E-R would also service areas that are poorly accessible, and the Ring Road's creation will spur development in some areas that were previously difficult to reach. Nordhavn is in development and will have a connection to the E-R. The city may develop Refshaleøen, currently owned by a pension group and a prospective building zone, if connected by the E-R.

A connection between Helsingørmotorvejen, the O2, and Nordhavn was the only project that the municipality is undertaking to actively reduce traffic in Copenhagen. The connection was the first stage of the tunnel design in the E-R proposal. There was a large majority of city hall, including Lars Weiss, in favor of congestion charges. The congestion charges would charge people for going to central Copenhagen and create revenue to help pay for further traffic solutions, such as the E-R or the Metro.

When asked about the Ladegårdsåen, Lars Weiss believed that there were two aspects to the project. It would not increase the number of roads in Copenhagen because it would be replacing an old road, and it would bring a much-needed recreational area to a part of the city that did not have much park space. However, in order to acquire proper funding by the municipality, some of the street area freed up would have to be reserved for housing developments. The idea of a long green lawn running into the city is more of a dream than a reality as stated by Mr. Weiss.

While the Metro would reduce the number of commuters, it would only solve part of the traffic problem. Future projects for the next ten years would include further Metro construction, improving the current bus system, and possibly the creation of a light rail or tram system. The E-R was also a major point of discussion in the most recent election, making it a more likely possibility. The E-R would still be 25 years away, but now is the time to start debating it, according to Lars Weiss. While much of city hall approves of the E-R, their approval will not matter if the government does not commit to the E-R because the municipality will be unable to fund it on its own.

In reference to the public opinion of the E-R, Lars Weiss said, “it’s very favorable...maybe not very”. He goes on further to say that “When you talk about the tunnel at the abstract level, almost every person in Copenhagen thinks it’s a good idea. But when you begin to make lines on the map and say here’s the beginning of the tunnel, here’s the end, and then the skepticism arises”. Because the tunnel surfaces in Amager Fælled, there is a lot of debate over the tunnel and the necessity of the tunnel going through the green space. The service road built in the surfaced section would not service as many people as other exits and there is no real need for the exit, believes Lars Weiss, who also lives near the proposed exit. While he is in favor of the tunnel, he does not believe that it should surface in Amager Fælled. Part of the misunderstanding, Mr. Weiss said, was that the municipality would complete the upper sections, all the way from Helsingørmotorvejen to Northern Amager. If those sections were completed then a ring would form, but on the surface rather than underground. In order to reduce the traffic in Amager the municipality must build the remainder of the tunnel so cars are underground instead of on the surface, suggested Mr. Weiss.

After the interview, the team asked Mr. Weiss to rank aspects of tunnel design but he did not submit a response. As a result, the project team could not generate a pairwise comparison to reflect his opinion.

4.2. Scenario Compilation Overview



Figure 23 - Compilation of Tunnel Designs

| Scenario # | Description | Compilation |
|------------|-------------------------------|---|
| Scenario 1 | Eastern Ring Road (E-R) | |
| Scenario 2 | E-R connected to E20 | Based on Scenario 1 with different exit |
| Scenario 3 | Ladegårdsåen with E-R exit | |
| Scenario 4 | Ladegårdsåen connected to E20 | Based on Scenario 3 with different exit |
| Scenario 5 | Y-Connection to E-R exit | Scenario 1 + Scenario 3 |
| Scenario 6 | Y-Connection to E20 | Scenario 2 + Scenario 4 |
| Scenario 0 | Nothing is done | |

Table 9 - Overview of Compilation of Tunnels

4.3. Scenario 1 – Eastern Ring Road



Figure 24 - The Eastern Ring Road's Route Highlighted on a Satellite Image

4.3.1. [Eastern Ring Road Tunnel Overview](#)

| | |
|---|--|
| Entrance and Exit Locations | <ul style="list-style-type: none"> • North: Strandvænget (an extension of Nordhavnsvej) • In Ydre Nordhavn • Refshalevej on Refshaleøen • At Forlandet / Kløvermarksvej north of Kløvermarken • Artillerivej at the western side of Amager Fælled • South: Sjaellandsbroen and Amager motorway |
| Tunnel Length | 12.5 kilometers |
| Maximum Flood Water Volume (approx.) | 399,800 cubic meters |
| Estimated Driving Time at 90 km/h | 8.3 minutes |
| Estimated Driving Time at 110 km/h | 6.8 minutes |
| Tunnel Junctions | None |
| Parking Locations | No parking included |

Table 10 – Eastern Ring Road Tunnel Overview

4.3.2. [Reasoning behind the Eastern Ring Road Route](#)

The E-R is the Transportministeriet’s counterproposal to the Copenhagen Harbour Tunnel. Instead of following the harbor along western Amager, the E-R acts as an eastern extension of the O2 ring road. The purpose of the O2 is to direct traffic trying to get through the city, around the city instead. In theory, this minimizes the amount of unnecessary traffic in the city center. However, the O2 runs west of the city, and then through the city center, instead of east of it. This adds to the traffic congestion problem in central Copenhagen.

In what could ultimately become part of the O2, the E-R takes the traffic that goes through the center of the city and diverts it underground and around the heart of Copenhagen. Making the E-R not only creates a greater city ring, but the city gets government funding for the construction of ring roads.

4.3.3. Thought behind the Traffic Flow

Southbound Traffic



Figure 25 – Hypothesized Southbound Traffic Flow for the Eastern Ring Road

The general thought behind the E-R's route is that commuters coming from the north will use this route to get to the harbor developments (Nordhavn and Refshaleøen), eastern Amager (Amager Øst), or completely around the city to the E20 European highway (see Figure 25). Residents in Østerbro can use the E-R to get to work in Amager or further south of the E20. If residents in Østerbro are going west to Nørrebro or Frederiksberg, they can take the O2. With the extension of the Metro to four lines (M1, M2, M3, M4), it will service residents trying to get to

any of the inner city districts and they will be less inclined to drive to work.

Northbound Traffic



Figure 26 – Hypothesized Northbound Traffic Flow for the Eastern Ring Road

The way northbound traffic flow reacts to the E-R is nearly identical to how the southbound traffic flows. Commuters traveling from the south have the option to take the E20 or O2 to get to the E-R. Workers coming from Sweden have the option to take the train or travel west on the E20 before heading north on the E-R. The ability of the tunnel to funnel traffic underground in a confined space maintains a regulated traffic flow, which quickly brings commuters to their destination in Østerbro or further north. Similar to southbound traffic, northbound traffic can

avoid the inner city entirely, which improves travel time for through traffic and traffic on the surface.

4.3.4. Exit and Entrance Locations

This section discusses the six exits/entrances that will allow access to the E-R. The section also provides a discussion of the reasoning for each tunnel and what areas they service. Figures associated with each tunnel provide a visual representation of overlays of what the exits will look like and what the areas around the exits currently look like.

The North Entrance (Østerbro)

The E-R begins on a road, Strandvænget, on the eastern side of Østerbro. This small eastbound road near the O2 (see Figure 27), provides an easy exit for commuters on the O2. The area surrounding Strandvænget is a residential neighborhood (see Figure 28), but the street itself sees 12.3 thousand cars daily according to Figure 29. This number will grow in the coming years as commuters head towards the O2. The E-R combats the future traffic problem by diverting cars underground so only through traffic can go through. Cars that need to access the side streets remain on the surface and everything else goes east to the O2 and Nordhavn.

Another driving factor in the placement of this entrance is that the tunnel is already under construction there. This tunnel is the theoretical first phase of the E-R, providing the perfect justification for continuing the tunnel from here.

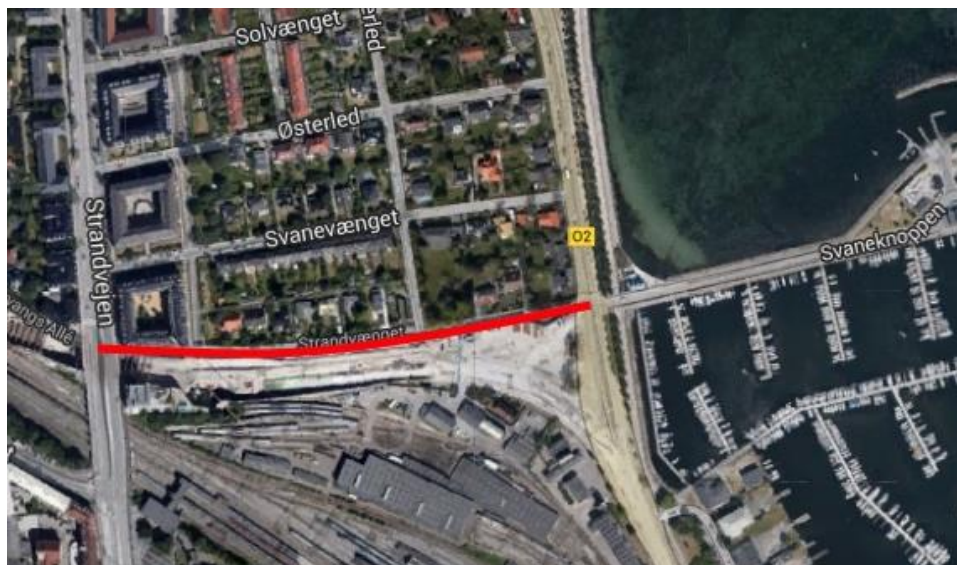

Figure 27 - Satellite Image of Strandvænget and the O2



Figure 28 - A View of Strandvænget and the O2 from the South

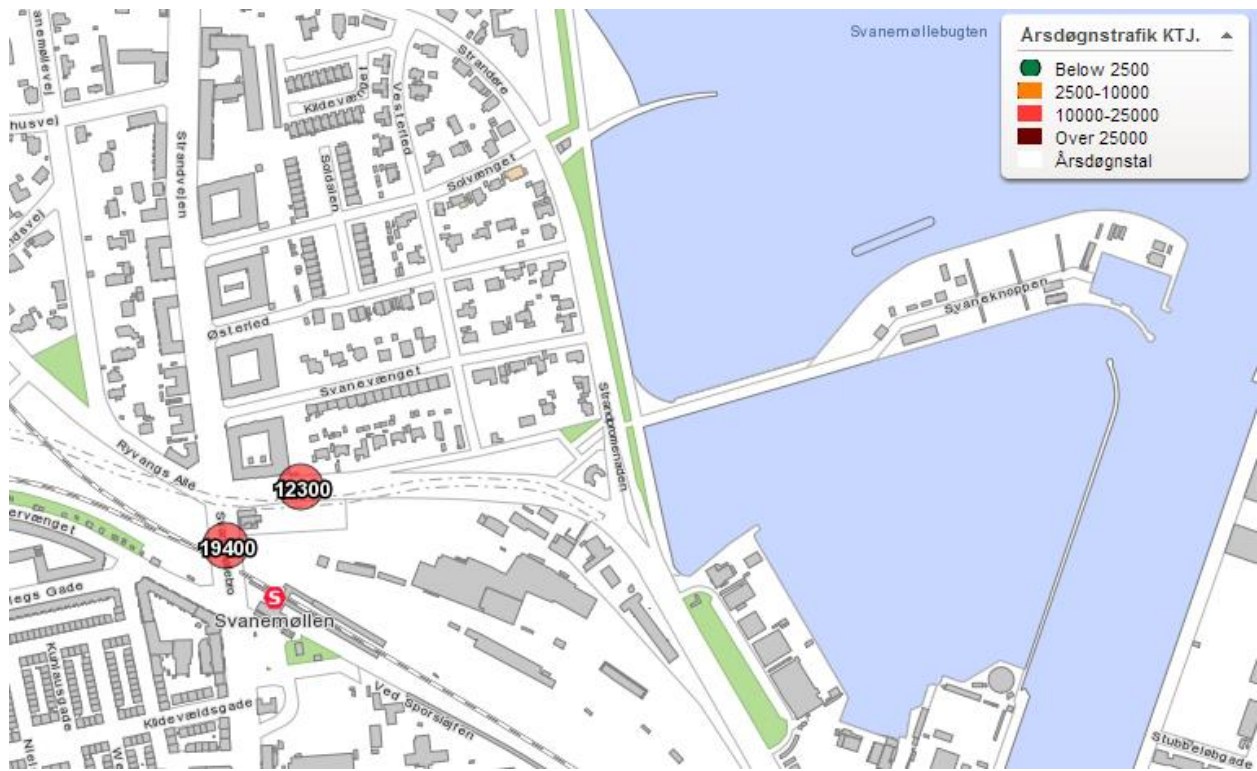

Figure 29 – Average Number of Cars per Day Over a Year Near Strandvænget

Nordhavn Harbor Development

Currently, Nordhavn (see Figure 30) is under development and will become a residential area. However, Nordhavn now has only buses and one road that connects to the mainland (see Figure 31). In the future, this will make it difficult for residents and visitors alike to access the development. As part of the solution to deal with this influx of people, the E-R plans to connect

these people to the rest of Copenhagen via car (see Figure 32).

However, this raises questions as to the message Copenhagen is trying to send to its citizens. If the E-R is established, it encourages the use of cars. However, to what extent? Does it encourage the everyday use of cars, or just the casual commuter who travels by car once a week? Some may argue that this message contradicts Copenhagen's goal of becoming carbon neutral by the year 2025. However, if the city establishes the proper public transportation infrastructure, it encourages Nordhavn's residents to choose that over driving a car.

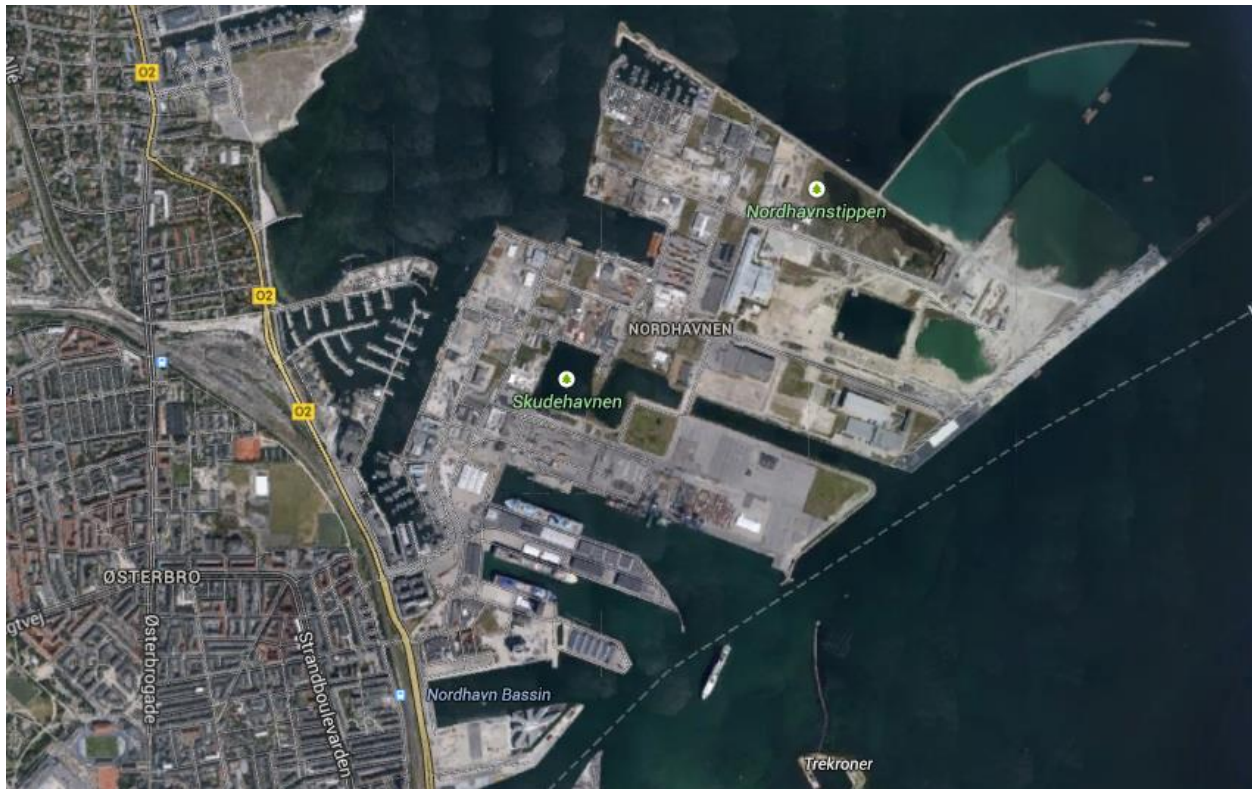

Figure 30 - Satellite Image of Nordhavn Harbor Development

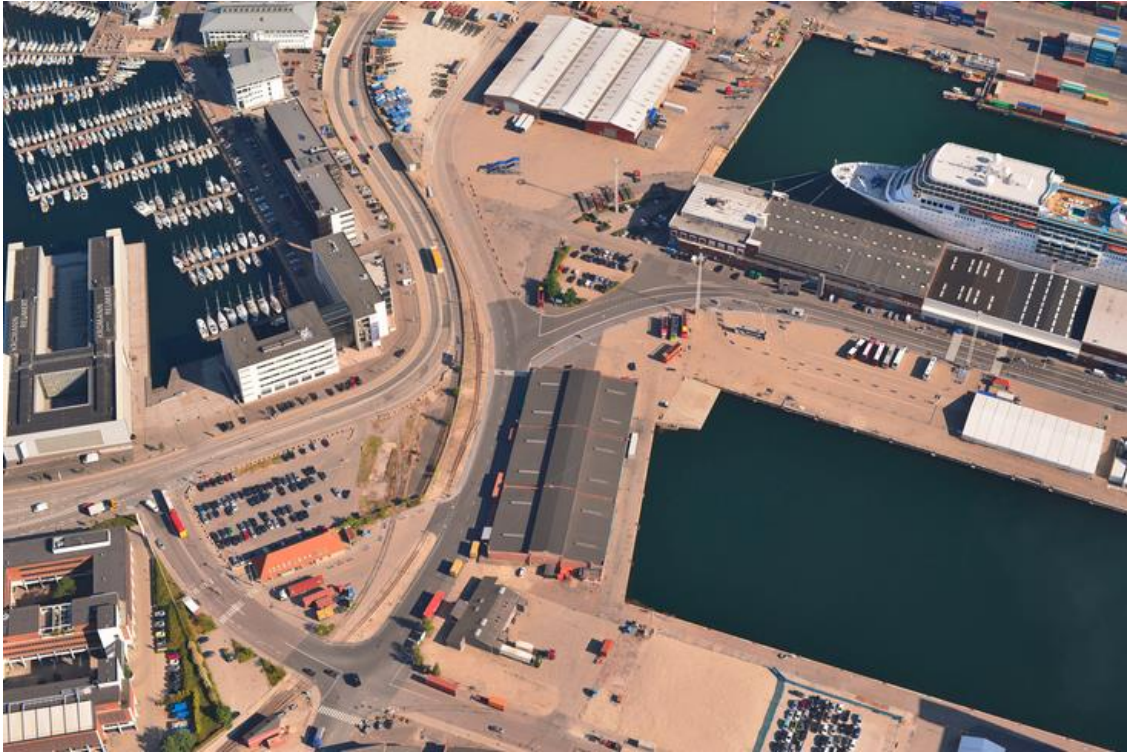

Figure 31 - Entrance/Exit to Nordhavn Harbor Development, View from the South



Figure 32 - Eastern Ring Road Entrance/Exit on Nordhavn

Refshaleøen Harbor Development

Refshaleøen is another harbor development south of Nordhavn. Like Nordhavn, Refshaleøen has limited access to the rest of Copenhagen and only one road connecting to the rest of the city, as seen in Figure 33. Once fully developed, the only way Refshaleøen's residents can access the mainland is by driving on the one service road (see Figure 34) or by taking a ferry. Both options

are inefficient, so instead the E-R creates an entrance and exit on Refshaleøen similar to Nordhavn (see Figure 35). Commuters have the option to take the main road or the E-R to Amager. Similarly, commuters also have the option to go north on the E-R to Nordhavn and Østerbro, providing full connection to the north and south of the city.

One can argue that building a road that connects Refshaleøen to the rest of Copenhagen encourages car usage, thus creating more harmful air and noise pollution. However, with just one road servicing the peninsula and thousands of residents expected to move in by the time it is completed, there is a clear need for a connection between the development and the rest of Copenhagen. Similar to the situation in Nordhavn, in order to encourage residents not to use cars as a primary mode of transportation, the proper public transportation infrastructure needs to be established.

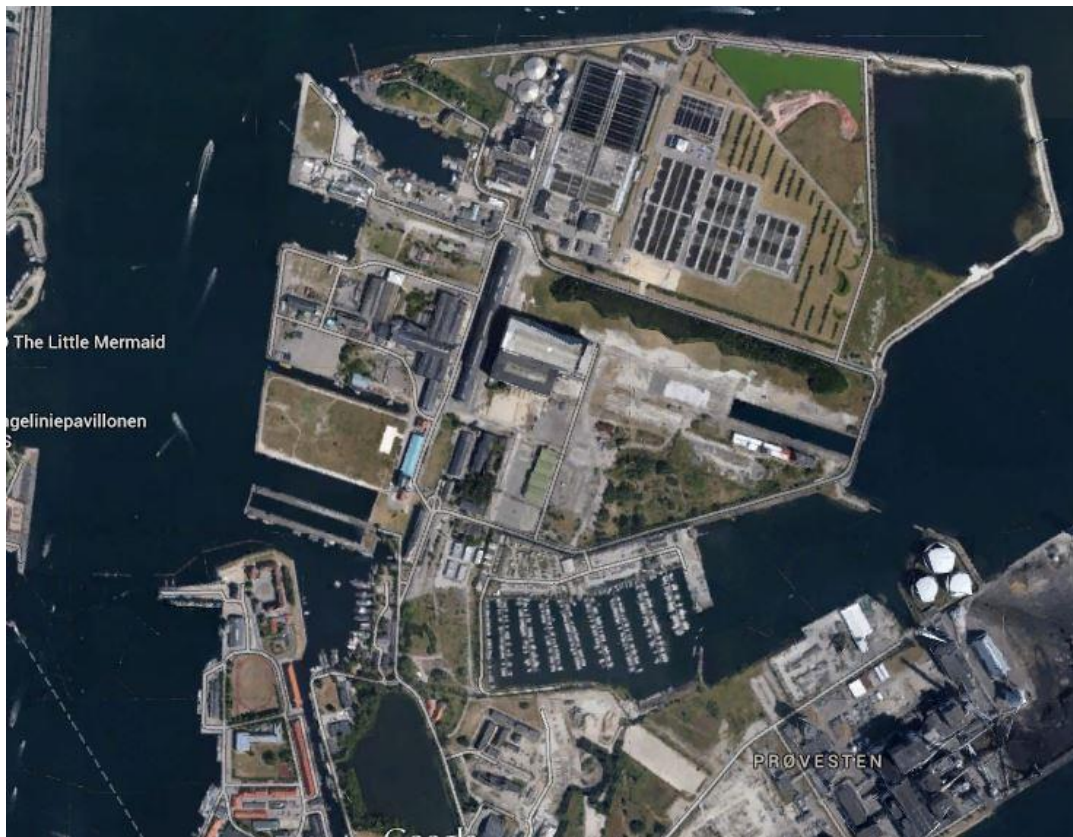

Figure 33 - Satellite Image of Refshaleøen Harbor Development



Figure 34 – Refshalevej, Refshaleøen's Only Road Entrance/Exit, View from the South



Figure 35 – Eastern Ring Road Entrance/Exit on Refshaleøen

Forlandet / Kløvermarksvej North of Kløvermarken

The E-R's third entrance/exit, and first on Amager's mainland, is on Kløvermarksvej (see Figure 36 and Figure 37). As the only entrance east of Amager Fælled that is easily accessible for the residents and workers of Amager Øst, the proposed access point (see Figure 38) keeps them from traveling to Refshaleøen, the E20, or through the heart of Copenhagen to get to their destination. Its sole purpose is to service these people in an easily accessible manner. With much of the area open or used for green space, adequate space exists for the city to put connecting roads in place to improve traffic flow to and from the area, while increasing the tunnel's accessibility in eastern Amager.

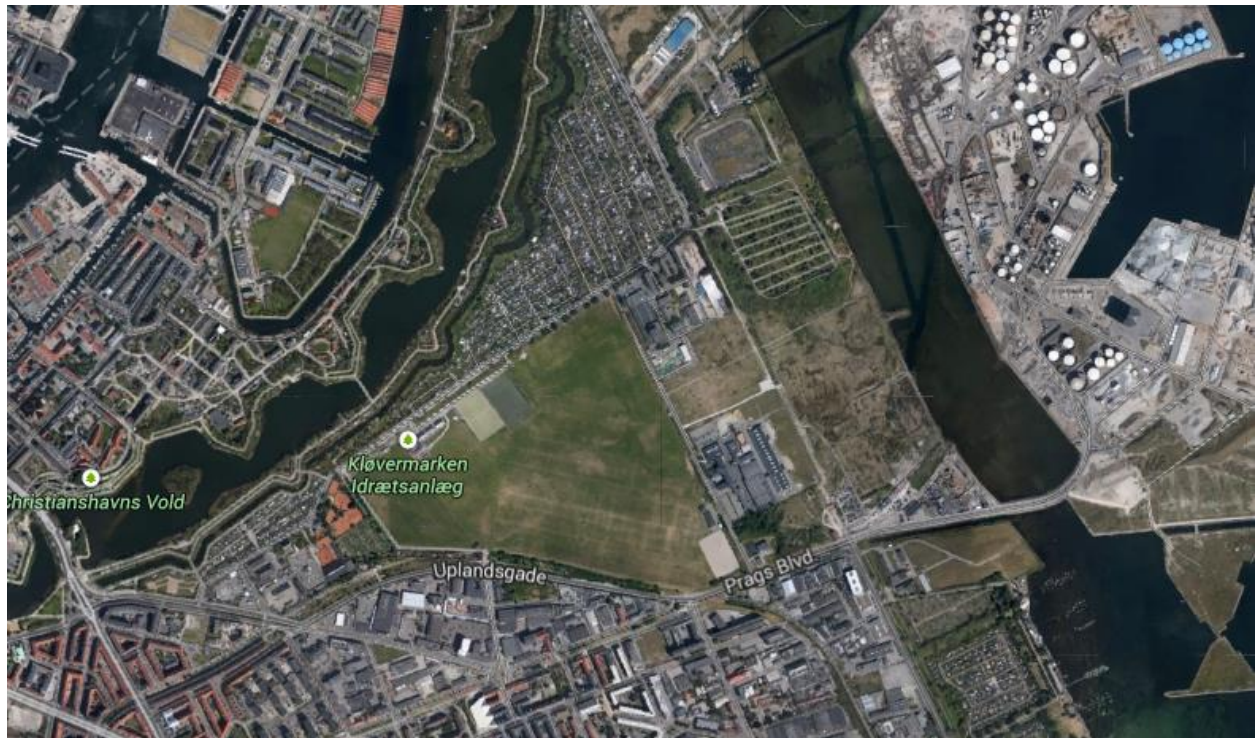

Figure 36 – Satellite Image of Kløvermarksvej



Figure 37 – Kløvermarksvej, View from the South



Figure 38 – Eastern Ring Road Entrance/Exit near Kløvermarksvej

Artillerivej and Western Amager Fælled

The E-R's most controversial exit/entrance location is in western Amager along Artillerivej and Amager Fælled as seen in Figure 39. To build this above ground exit, Amager Fælled has to support a transition between a boring machine and a cut and cover portion that would allow the road to exit the tunnel and surface. The construction of the road destroys the green space along its path towards the E20. It also upsets the future residents of the housing developments under construction along Amager Vest's harbor boundary (see Figure 40). The influx of cars to the area, because of the exit/entrance, creates harmful air pollution and disruptive noise pollution and lower local property value.



Figure 39 – Satellite View of Amager Fælled, Artillerivej, and Ørestads Boulevard

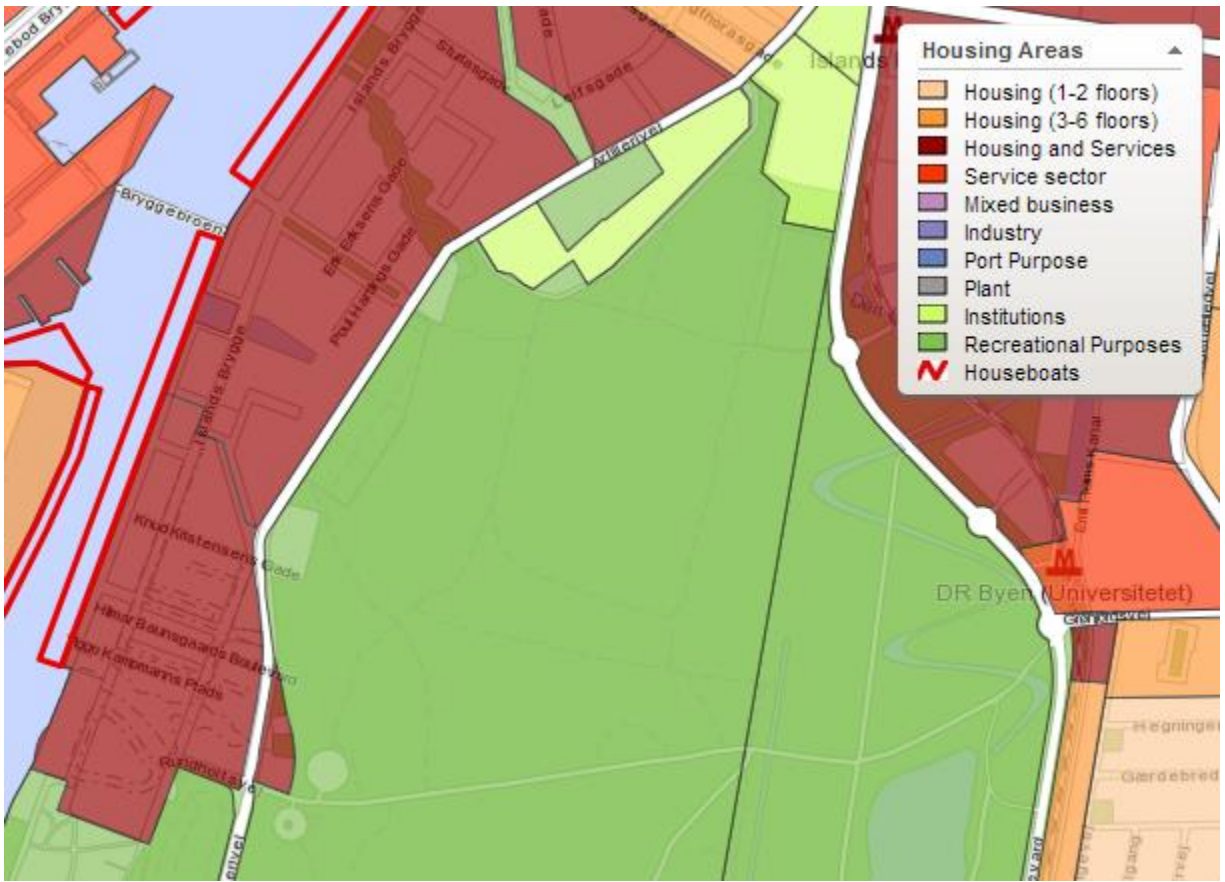

Figure 40 – Western Amager's Residential Area Construction Plans



Figure 41 – Eastern Ring Road Exit in Amager Fælled and at Artillerivej

Sjællandsbroen and Vejlands Allé Connection by the E20

The E-R's final exit/entrance location is located at the Sjællandsbroen / Vejlands Allé intersection (see Figure 42) by the E20 European highway. This is a logical location for an entrance/exit because of its close proximity to the heavily travelled E20 and the O2. This connection completes the ring and enables the E-R to become the eastern extension of the O2 ring road. Traffic coming from the south and from Sweden can follow the highway to the northern districts of Copenhagen without causing congestion in the center of the city.

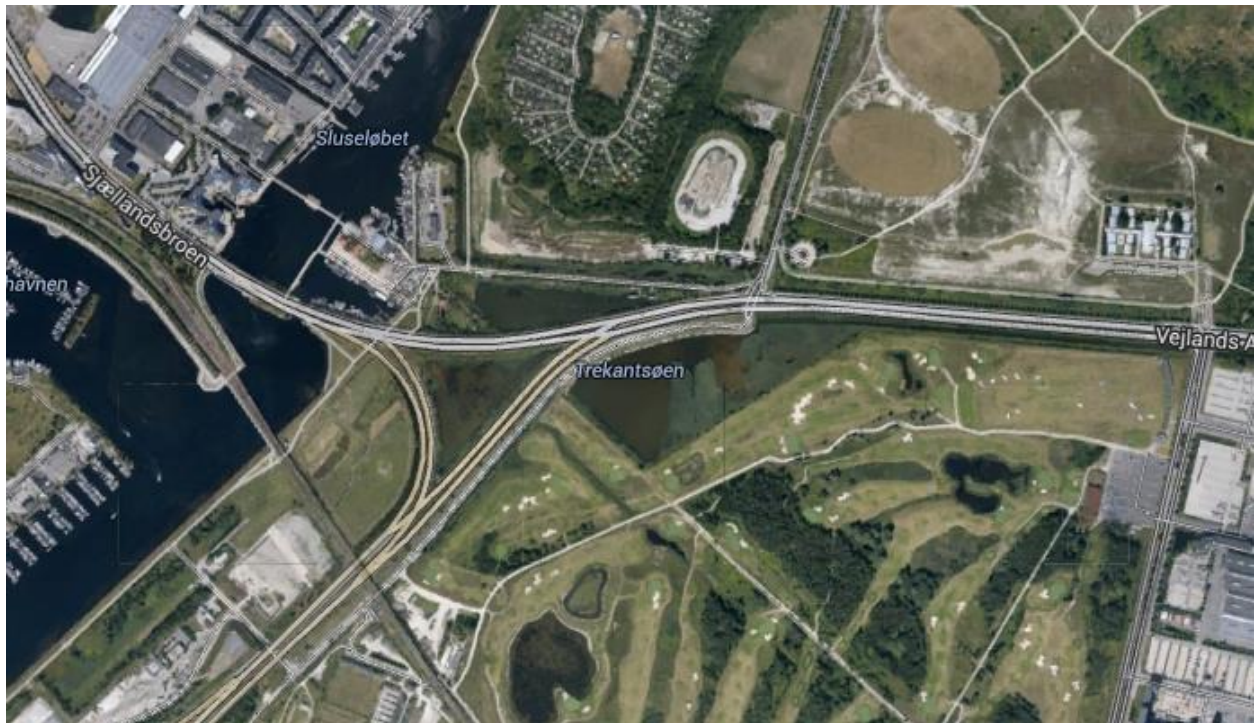

Figure 42 – Satellite image of Artillerivej, Sjællandsbroen, Vejlands Allé, and the E20

4.3.5. [Pros and Cons of the Eastern Ring Road](#)

| Pros | Cons |
|---|---|
| Services Nordhavn | Surfaces in Amager Fælled and splits the park |
| Services Refshaleøen | Adds traffic to a congested intersection at southern exit |
| Completes a traffic ring around central Copenhagen | Adds traffic to Amager Vest on Artillerivej |
| Diverts through-traffic around the city center | - |

Table 11 – Pros and Cons of Eastern Ring Road Tunnel

The E-R scenario services both the possible harbor developments, Nordhavn and Refshaleøen, as

detailed above. It diverts traffic from the city center by completing the eastern portion of the city ring. The E-R will surface in the conservation area of Amager Fælled. This reduces the amount of usable green space and disrupts the park's identity as a nature park. This plan also contributes to congestion at its southern exit. The intersection of Sjaellandsbroen, Artillerivej, and Vejlands Allé is already busy and experiences some of the worst traffic conditions on the island of Amager. This exit complicates the situation by adding more traffic and another road connection. The exit to Artillerivej on the western side of Amager Fælled adds more traffic to the community of Amager Vest and reduces the appeal of the harbor area that the area has cultivated.

4.4. Scenario 2 – Eastern Ring Road by Field’s Shopping Center

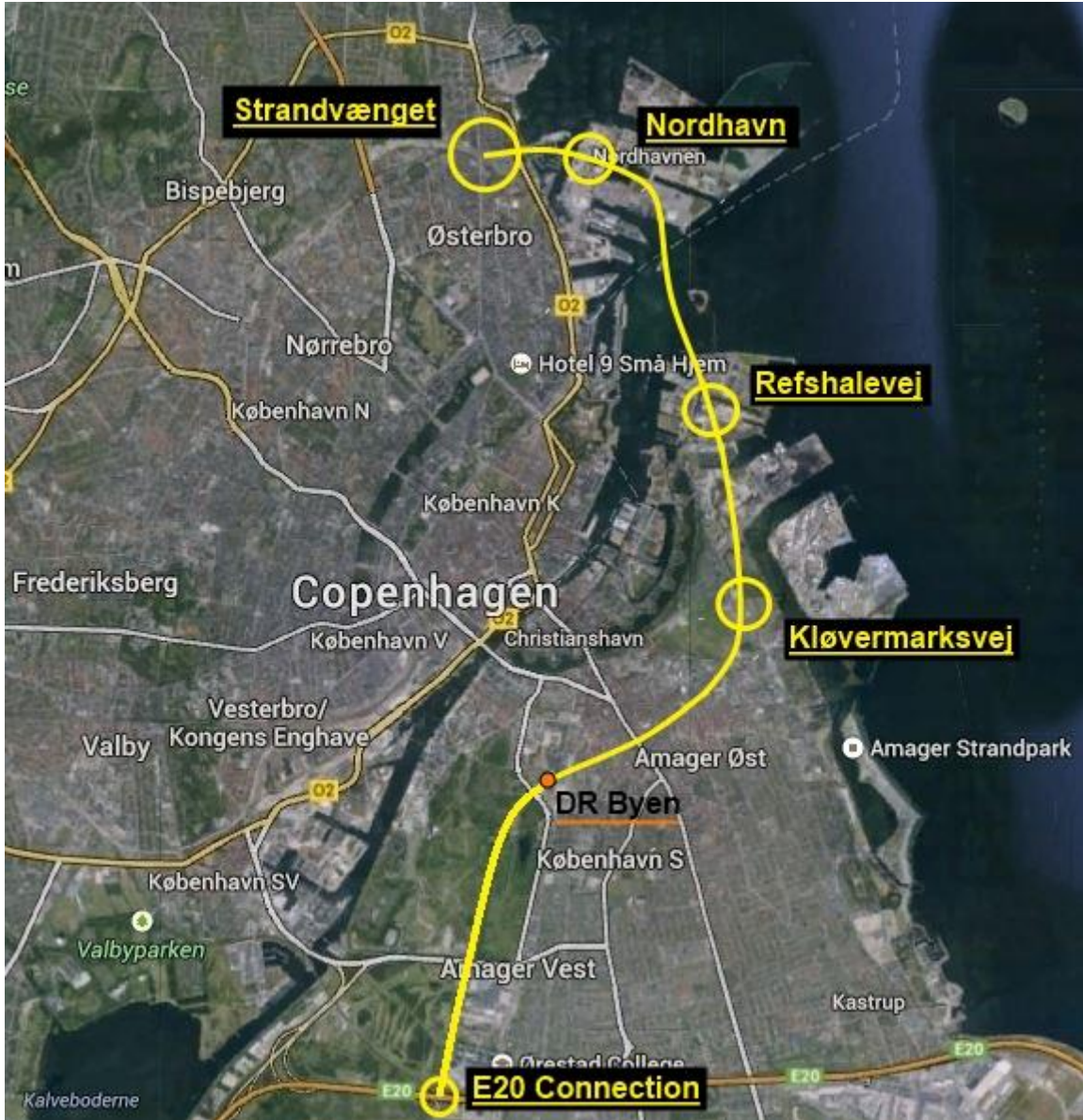

Figure 43 – Eastern Ring Road by Field’s Highlighted Route on a Satellite Image

4.4.1. [Eastern Ring Road by Field's Overview](#)

| | |
|---|--|
| Entrance and Exit Locations | <ul style="list-style-type: none"> • North: Strandvænget (an extension of Nordhavnsvej) • In Ydre Nordhavn • Refshalevej on Refshaleøen • At Forlandet / Kløvermarksvej north of Kløvermarken • South: E20 west of Fields (possible underground exchange) |
| Tunnel Length | 12.73 kilometers |
| Maximum Flood Water Volume (approx.) | 407,156 cubic meters |
| Estimated Driving Time at 90 km/h | 8.5 minutes |
| Estimated Driving Time at 110 km/h | 6.9 minutes |
| Tunnel Junctions | None |
| Parking Locations | No parking included |

Table 12 – Eastern Ring Road by Field's Overview

4.4.2. [Reasoning behind Eastern Ring Road by Field's Route](#)

Since the northern sections of the Eastern Ring Road by Field's are the same as the E-R, they have the same rationale. The origin of this scenario is the team's desire to avoid surfacing in Amager Fælled by finding an alternate exit. This route focuses on avoiding major construction in Amager Fælled, which would destroy a large portion of Amager's green space. Instead of surfacing in Amager Fælled, the E-R turns south at DR Byen near the Københavns Universitet Søndre Campus as seen in Figure 43. Though this area is currently under construction and is near the M1 line of the Metro, it is possible that there is enough space for a construction site if need be (see Figure 44).

The route crosses Amager Fælled as it runs parallel to Ørestads Boulevard. Since this scenario includes a plan to bore the tunnel, this minimizes construction that will take place in Amager Fælled. Compared to the E-R, which surfaces at the start of Amager Fælled and runs the length of it above ground, the E-R that passes by Field's preserves green space instead of destroying it.

The final section of the tunnel follows Center Boulevard, which is on the western side of Field's shopping complex. As shown in Figure 45, there is already a full exchange interchange for commuters entering and exiting the E20. There is also substantial room for construction. The

land east of Center Boulevard is a development area for housing and retail (Figure 46), which cannot be a tunnel exit onto the E20. However, the land to the west is not a planned development zone. It also has the necessary 300 to 500 meter clearance room (estimated based on maps of E-R designs) for the transition from boring to the cut and cover construction of the exit.



Figure 44 – DR Byen Metro Station and Construction near the University, View from the South



Figure 45 – View of the E20 Highway West of Fields' Shopping Complex, View from the South



Figure 46 – Housing and Retail Zoning Map of the E20 / Ørestads Blvd. Intersection Area

4.4.3. [Thought behind the Traffic Flow](#)

The thought behind the traffic flow resulting from Scenario 2, the E-R by Field's, is the same as for the E-R in its northern sections. Although the exit/entrance location of the Eastern Ring Road by Field's is farther east than the E-R's, the justification is the same. Traffic coming from the south and from Sweden can easily access this tunnel by taking the E20 to the tunnel connection. Commuters can also travel to Refshaleøen, Nordhavn, Østerbro, the northern tip of Amager, and other northern districts.

4.4.4. [Exit and Entrance Locations](#)

The exit/entrance locations of the Eastern Ring Road by Field's are similar to those of the E-R. The only differences are the southernmost exit/entrance, which would connect directly to the E20 and the removal of an exit in Amager Fælled. The purpose of this option is foremost to reduce the amount of damage to Amager Fælled. The E20 connection provides people traveling along the E20 from lower portions of Zealand or from Sweden a route to northern Copenhagen without struggling through traffic. Additionally, this exit is in close proximity to the E20 exit closest to Field's, which provides travel from northern parts of Copenhagen to the Field's shopping complex, and gives people living in the future Ørestad development a route to northern Copenhagen without having to cross the city center.

4.4.5. [Pros and Cons of Eastern Ring Road by Field's](#)

| Pros | Cons |
|---|---|
| Services Nordhavn | May reduce green space at southern exit |
| Services Refshaleøen | May cause objections to an exit's construction at the edge of the Royal Golf Center |
| Completes a traffic ring around central Copenhagen | Possible underground connection to E20 could be expensive |
| Diverts through-traffic around the city center | - |

Table 13 – Pros and Cons of Eastern Ring Road by Field's

Similar to the E-R, this tunnel services both possible harbor developments, Nordhavn and Refshaleøen, and diverts traffic from the city center by completing the eastern portion of the city ring. This tunnel reduces the amount of usable green space at its southern exit. The land is currently undeveloped where the connection to the E20 is. It is between the Royal Golf Center

and the Field's shopping center. There might be opposition to this plan from the Royal Golf Center or Field's for adding traffic and additional noise pollution to the area. This plan does not surface in conservation land and does not disrupt Amager Fælled. An underground connection between the tunnel and the E20 might be possible if a portion of the E20 was included in the tunnel.

4.5. Scenario 3 – Ladegårdsåen Extended Tunnel

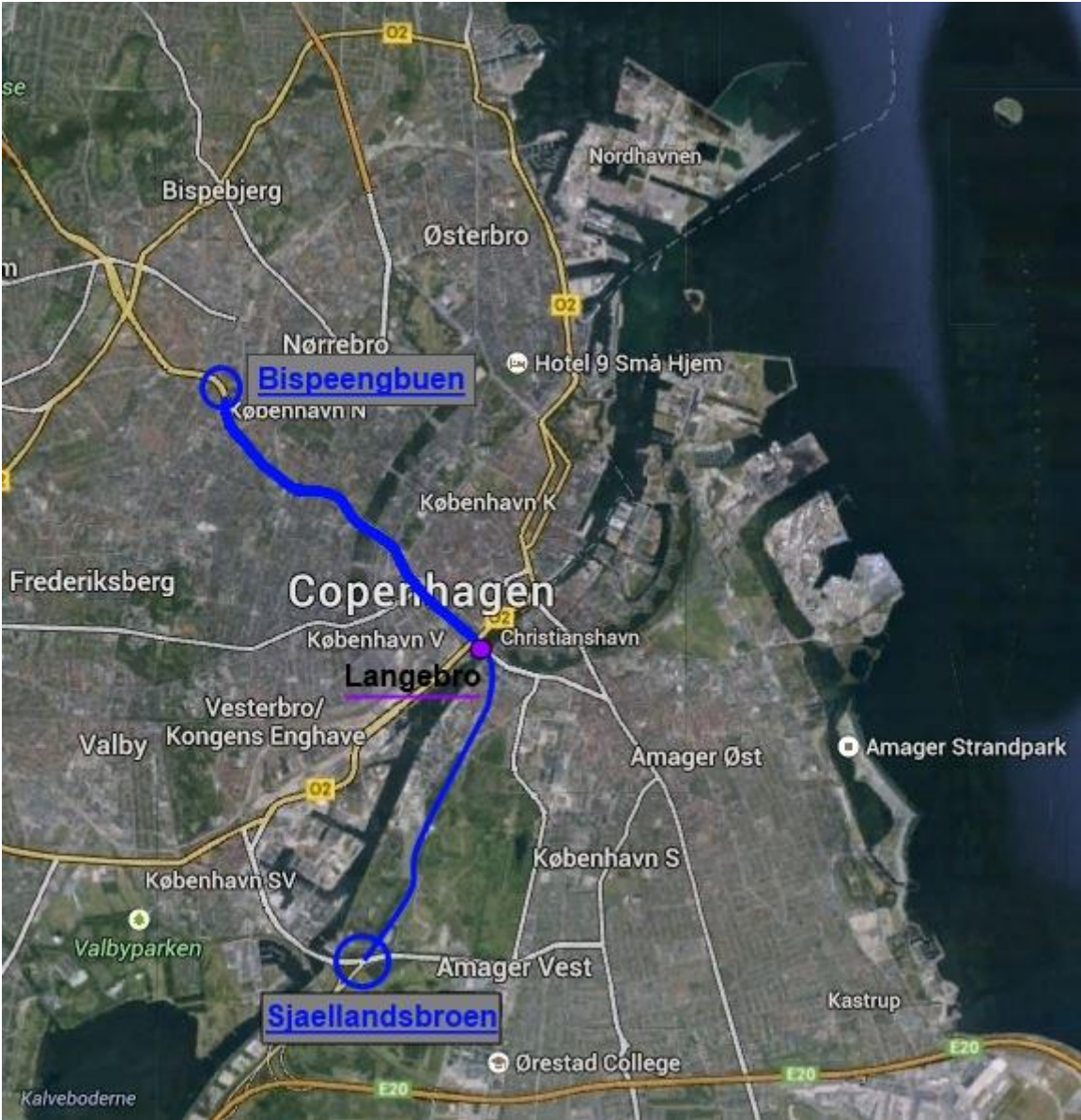

Figure 47 – Ladegårdsåen Extended Tunnel’s Route Highlighted on a Satellite Image

4.5.1. [Ladegårdsåen Extended Tunnel Overview](#)

| | |
|---|--|
| Entrance and Exit Locations | <ul style="list-style-type: none">• North: Bispeengbuen at Borups Place• South: Sjaellandsbroen and Amager motorway |
| Tunnel Length | 7.2 kilometers |
| Maximum Flood Water Volume (approx.) | 230,284 cubic meters |
| Estimated Driving Time at 90 km/h | 4.8 minutes |
| Estimated Driving Time at 110 km/h | 3.9 minutes |
| Tunnel Junctions | None |
| Parking Locations | At Rådhuspladsen |

Table 14 – Ladegårdsåen Extended Tunnel Overview

4.5.2. [Reasoning behind Ladegårdsåen Extended Tunnel Route](#)

The route for the Ladegårdsåen Extension is a combination of the route proposed by the 2012 WPI IQP team in “Flood Prevention and Daylighting of the Ladegårdsåen” and a tunnel that runs the length of Artillerivej, devised by this project’s team. The municipality of Copenhagen is investigating the feasibility of the Ladegårdsåen route. According to the floodwater map Mr. Fink provided, (Figure 54) and traffic calculations in Section 4.10.3, the route and tunnel design efficiently reduces traffic flow and collects a significant amount of Nørrebro’s floodwater during cloudbursts.

The lower section of this route avoids surfacing in Amager Fælled while also completing the ring road that the E-R would form if underground. The exit provides a multitude of connections to different areas of Copenhagen. The route acts as a connection across the city from northern Copenhagen to Amager.

4.5.3. [Thought behind the Traffic Flow](#)

The traffic flow for the Ladegårdsåen Extension is similar to that of the E-R at its southern entrance. People entering the tunnel at the southern entrance come from the central parts of the O2 and from the E20 to head up towards Nørrebro and to Hillerødmotorvejen, which leads out to a large regional community. Southbound traffic is essentially the opposite of northbound traffic. Residents of Nørrebro and people traveling along Hillerødmotorvejen can go straight through Copenhagen to access the E20 and lower parts of the O2. The connection also leads to Ørestad to enable people traveling to Sweden or the airport to take this route.

4.5.4. [Entrance and Exit Locations](#)

The 2012 Ladegårdsåen tunnel design and the E-R concept are the basis for the entrance and exit locations for the Ladegårdsåen Extension. The northern entrance/exit, based on the 2012 Ladegårdsåen project, connects to the Hillerødmotorvejen. The Ladegårdsåen Extension runs under the current road and the large majority of traffic already traveling along Ågade and Åboulevard will use the tunnel. The southern entrance/exit is similar to that of the E-R's southern exit/entrance. The exit connects to the O2 and the E20, providing service to people traveling across the city from the Ørestad area to Nørrebro. The proximity to Ørestad development also makes the new development more connected and accessible to the city.

4.5.5. [Inclusion of Parking](#)

In this scenario, an underground parking structure is located at Rådhuspladsen. There are currently about 6,000 parking spots in central Copenhagen. An additional 2,000 parking spots in a centrally located parking structure would be an appropriate amount of parking to reduce the number of parked cars on the surface and create more space for wider bike lanes and sidewalks (Personal communication with Anders Jørn Jensen, 2014). The reduction of parking spots on the surface encourages drivers to avoid driving to central Copenhagen on surface roads because it is more difficult to find available parking spots. This reduces the amount of traffic congestion, which makes traveling more safe and enjoyable for pedestrians and cyclists in the district.

The location of the possible parking structure is based on access to the new Metro station at Rådhuspladsen and its proximity to important locations in Copenhagen, including City Hall. The location is already a construction site, and it does not require demolition or excessive change to the area because it is at the edge of Rådhuspladsen. The Metro station will be 13 meters deep and the tunnel will most likely be between 35 and 40 meters deep at this location. The difference in depth allows the two tunnels (traffic and Metro) to pass without intersecting and leaves space for the construction of a multi-story parking structure.

People may be reluctant to use the tunnel to drive to the city center if built without a parking location here. It is possible that parking receipts from this parking garage could act as a Metro ticket to encourage more people to leave their cars and transfer to public transit here. This will eliminate the second cost of using public transit. The additional fee of parking might be a deciding factor in the number of people who choose to transfer to public transit from here. In

addition, the cost of parking under the city center could be a method of gathering revenue to offset the cost of building a tunnel.

Central Copenhagen is predominantly commercial. The expectation is that the majority of people who park in the garage will be people who work in central Copenhagen or visitors to the city center. People employed in central Copenhagen who drive to work will not lose the convenience of parking near their work and these commuters will no longer be driving through the surface streets. This reduces air and noise pollution from traffic in the city center. The expected improvement in air quality makes the district more pedestrian- and cyclist-friendly. People who cycle through the central district complain that breathing is noticeably harder when they are in central Copenhagen than when they are elsewhere in the city (Personal communication with Lise Nygaard Christensen and Kirsten Martensen of Miljøpunkt Amager, 2014).

4.5.6. [Pros and Cons of the Ladegårdsåen Extended Tunnel](#)

| Pros | Cons |
|--|--|
| Diverts through-traffic under city center | Adds traffic to a congested intersection at southern exit |
| Does not surface in Amager Fælled | Does not complete traffic ring around central Copenhagen |
| Can incorporate Ladegårdsåen surface design for the appropriate portion | Does not service Nordhavn |
| Provides parking in central Copenhagen | Does not service Refshaleøen |
| - | Construction along Artillerivej could impact local community |

Table 15 – Pros and Cons of Ladegårdsåen Extended Tunnel

The Ladegårdsåen Extension does not directly service either of the possible harbor developments, Nordhavn and Refshaleøen. It diverts traffic from the city center by putting it underground and provides parking and a connection to the Metro under Rådhuspladsen in central Copenhagen. The construction of this tunnel allows the city to complete the daylighting of the Ladegårdsåen canal, which creates more green space in Nørrebro. This plan does not complete the traffic ring around the city and contributes to congestion at its southern exit. The intersection of Sjaellandsbroen, Artillerivej, and Vejlands Allé is already busy and experiences some of the

worst traffic on the island of Amager. This exit complicates the situation by adding more traffic and another road connection. The exit to Artillerivej on the western side of Amager Fælled adds more traffic to the community of Amager Vest and reduces the appeal of the harbor area provided by the Eastern Ring Road scenarios.

4.6. Scenario 4 – Ladegårdsåen Extended Tunnel by Field’s Shopping Center

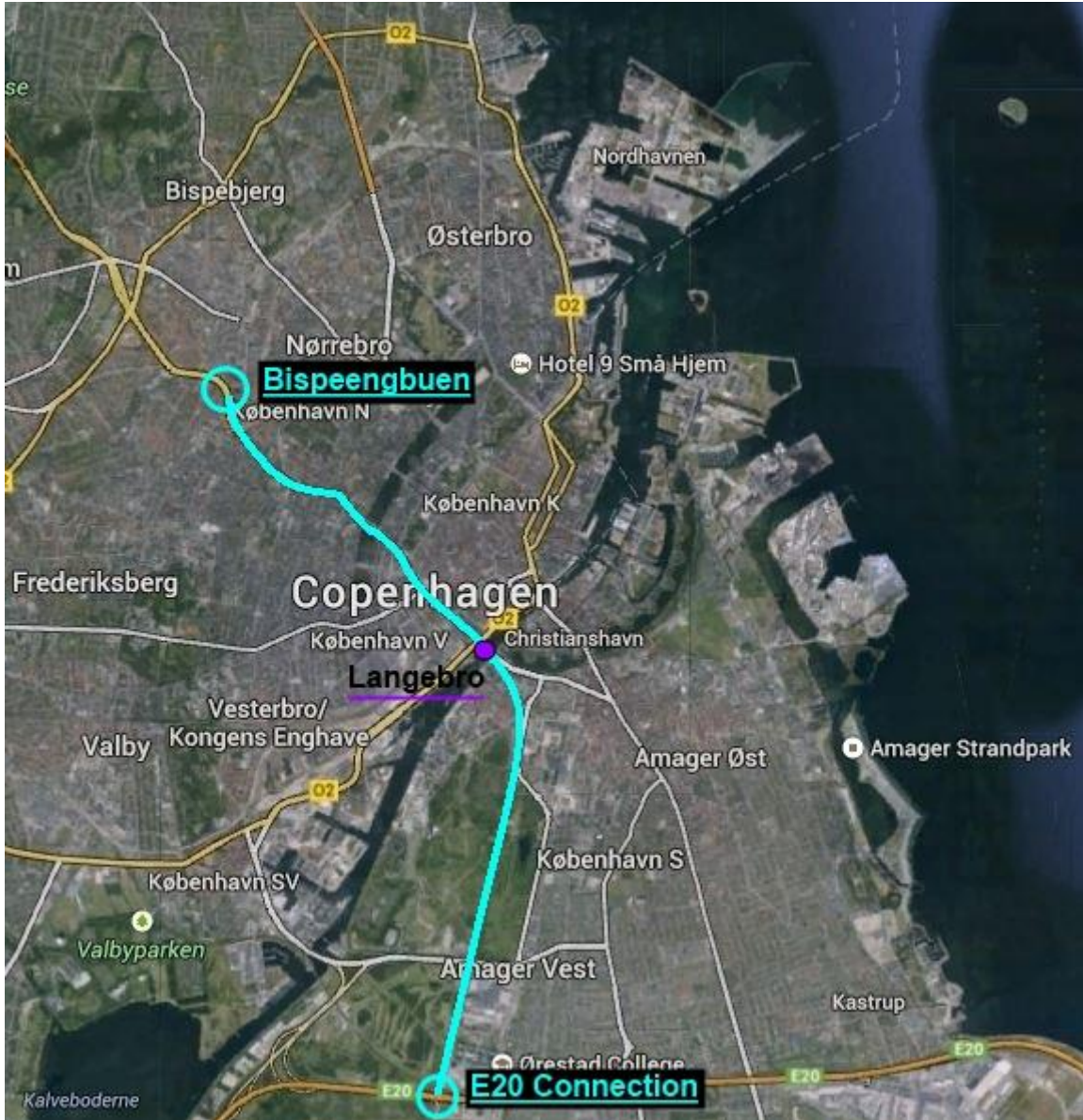

Figure 48 – Ladegårdsåen Extended Tunnel by Field’s Route Highlighted on a Satellite Image

4.6.1. [Ladegårdsåen Extended Tunnel by Field's Overview](#)

| | |
|---|--|
| Entrance and Exit Locations | <ul style="list-style-type: none"> • North: Bispeengbuen at Borups Place • South: E20 west of Fields (possible underground exchange) |
| Tunnel Length | 8.7 kilometers |
| Maximum Flood Water Volume (approx.) | 277,621 cubic meters |
| Estimated Driving Time at 90 km/h | 5.8 minutes |
| Estimated Driving Time at 110 km/h | 4.7 minutes |
| Tunnel Junctions | None |
| Parking Locations | At Rådhuspladsen |

Table 16 – Ladegårdsåen Extended Tunnel by Field's Overview

4.6.2. [Reasoning behind Ladegårdsåen Extended Tunnel by Field's Shopping Center](#)

Ladegårdsåen Extension by Field's is similar to the Ladegårdsåen Extension; it will connect western Copenhagen to Amager. The route follows Scenario 3 initially, while the later portion of the tunnel after Langebro Bridge follows a straight line down to the E20. This makes boring easier because it will not need to turn. There also exists a construction site near DR Byen for a boring site, which reduces damage to Amager Fælled.

4.6.3. [Thought behind the Traffic Flow](#)

The traffic flow for the Ladegårdsåen Extension by Field's is similar to that of Scenario 3 at the northern entrance. The differences between these scenarios are the locations of the Southern exit. The traffic flow should perform very similar to the Ladegårdsåen Extension, but there may not be as much use by people of the lower O2 region. Instead, people traveling from lower Zealand can connect to the tunnel in order to get to Nørrebro and northern areas of Copenhagen.

4.6.4. [Entrance and Exit Locations](#)

The Ladegårdsåen tunnel design and the Eastern Ring Road concept are the basis for the entrance and exit locations for the Ladegårdsåen Extension by Field's. Similar to Scenario 3, this tunnel exits along Ågade and Åboulevard, which leads to Hillerød motorvejen. The southern entrance/exit connects to the E20 directly and is close to the Ørestad exit along the E20, exactly like the E-R by Field's. The connection provides people of Amager a route across the city without having to struggle through city center traffic.

4.6.5. [Inclusion of Parking](#)

Parking at Rådhuspladsen is included in this scenario for the same reasons that it was included in the Ladegårdsåen Extension.

4.6.6. [Pros and Cons of Ladegårdsåen Extension by Field's](#)

| Pros | Cons |
|--|---|
| Diverts through-traffic under city center | Possible underground connection to E20 could be expensive |
| Does not surface in Amager Fælled | Does not complete traffic ring around central Copenhagen |
| Can incorporate Ladegårdsåen surface design for the appropriate portion | Does not service Nordhavn |
| Provides parking in central Copenhagen | Does not service Refshaleøen |
| - | May cause objections to an exit's construction at the edge of the Royal Golf Center |
| - | May reduce green space at southern exit |

Table 17 – Pros and Cons of Ladegårdsåen Extended Tunnel by Field's

The Ladegårdsåen Extension by Field's has the same concerns as the Ladegårdsåen Extension in respect to servicing the harbor developments and not completing the traffic ring around the city. Furthermore, as explained for the E-R by Field's, the southern exit may be unfavorable. The Ladegårdsåen Extension by Field's shares benefits with Scenario 3 by incorporating the surface road changes for the Ladegårdsåen canal and creating a parking location in central Copenhagen.

4.7. Scenario 5 – Y-Connection

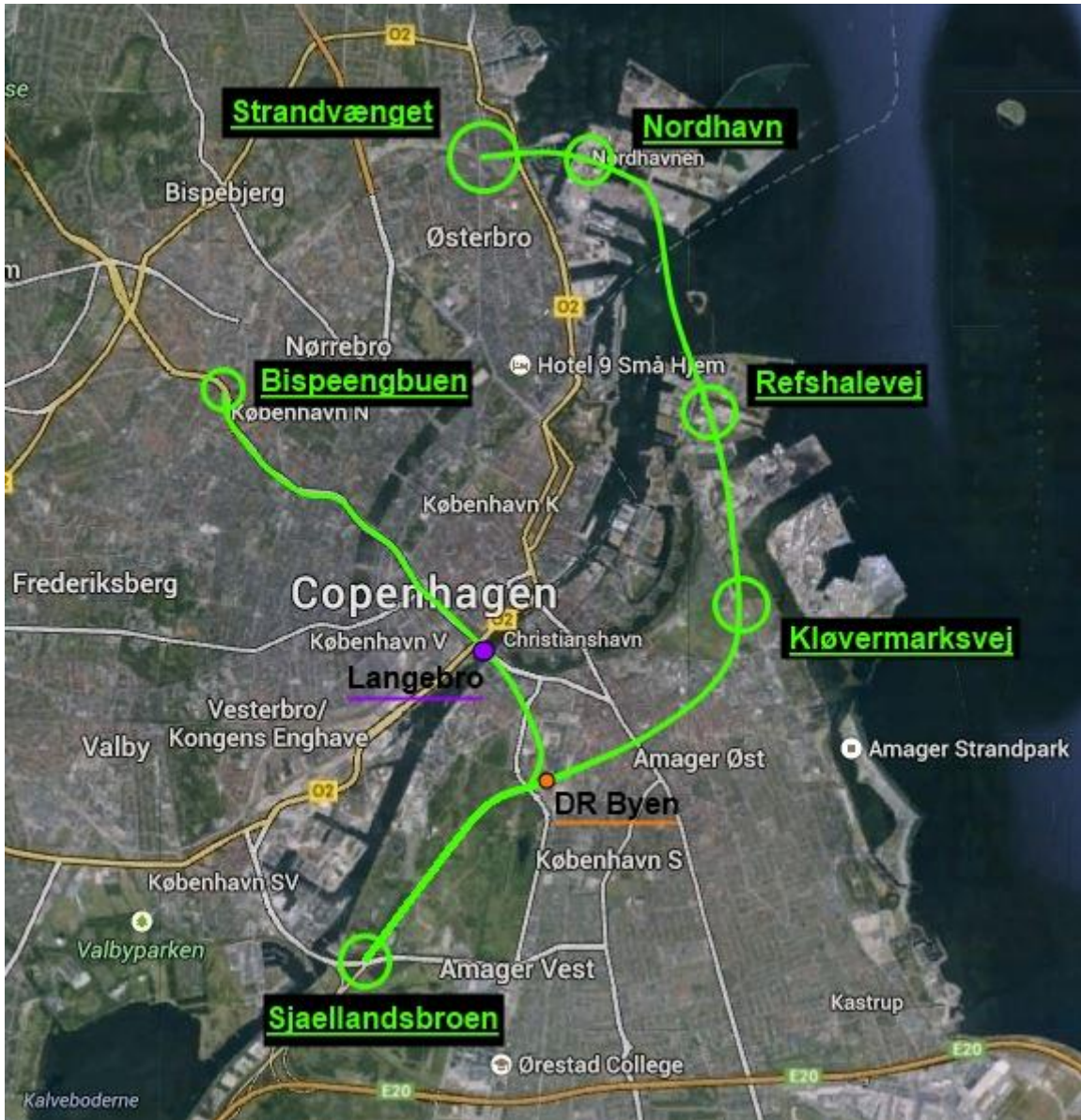

Figure 49 – The Y-Connection's Route Highlighted on a Satellite Image

4.7.1. Y-Connection Overview

| | |
|--|---|
| <p>Entrance and Exit Locations</p> | <ul style="list-style-type: none"> • North: Strandvænget (an extension of Nordhavnsvej) and Bispeengbuen at Borups Place • In Ydre Nordhavn • Refshalevej on Refshaleøen • At Forlandet / Kløvermarksvej north of Kløvermarken • Junction: DR Byen (no exit) • South: Sjaellandsbroen and Amager motorway |
| <p>Tunnel Length</p> | <ul style="list-style-type: none"> • From Strandvænget to Sjaellandsbroen and Amager motorway: 11.7 kilometers • From Bispeengbuen at Borups Place to Sjaellandsbroen and Amager motorway: 7.9 kilometers • Total: 17.4 kilometers |
| <p>Maximum Flood Water Volume (Approx.)</p> | <ul style="list-style-type: none"> • From Strandvænget to DR Byen: 305,447 cubic meters • From Bispeengbuen at Borups Place to DR Byen: 182,948 cubic meters • From DR Byen to Sjaellandsbroen and Amager motorway: 69,085 cubic meters • Total: 557,48 cubic meters |
| <p>Estimated Driving Time at 90 km/h</p> | <ul style="list-style-type: none"> • From Strandvænget to Sjaellandsbroen and Amager motorway: 7.8 minutes (11.7 km) • From Bispeengbuen to Sjaellandsbroen and Amager motorway: 5.3 minutes (7.9 km) |
| <p>Estimated Driving Time at 110 km/h</p> | <ul style="list-style-type: none"> • From Strandvænget to Sjaellandsbroen and Amager motorway: 6.4 minutes (11.7 km) • From Bispeengbuen to Sjaellandsbroen and Amager motorway: 4.3 minutes (7.9 km) |

| | |
|--------------------------|-----------------------------|
| | km) |
| Tunnel Junctions | Limited exchange at DR Byen |
| Parking Locations | At Rådhuspladsen |

Table 18 – Y-Connection Overview

4.7.2. [Reasoning behind the Y-Connection Route](#)

The route for the Y-Connection (Scenario 5) is a combination of the E-R and the Ladegårdsåen Extension. The idea behind it is that this scheme creates access to both Østerbro and Nørrebro from Amager. The northern entrances are in close proximity, and the entrances are also close to two different motorways. This permits travelers to cross the city without having to struggle to get to either tunnel entrance.

A junction would occur at DR Byen. The junction only combines southbound traffic. There is no need to allow access from the E-R portion of the tunnel towards the Ladegårdsåen because the northern entrances are close enough. Vehicles trying to get to the harbor developments would have to take the E-R or southern entrances instead of the Ladegårdsåen entrance. Northbound traffic splits into either the E-R route or the Ladegårdsåen route at the junction.

4.7.3. [Thought behind the Traffic Flow](#)

The traffic flow for the Y-Connection is a combination of the E-R and the Ladegårdsåen Extension. The southern entrance/exit gives access to both Nørrebro and Østerbro from the E20, the O2, and portions of Ørestad. The northern entrance along the Ladegårdsåen route cannot access the northern entrance of the E-R route through the tunnel, due to the proximity of the two entrances. Therefore, all northern entrance traffic heads south, which access to the E20, O2, Ørestad, and Sweden.

4.7.4. [Entrance and Exit Locations](#)

The entrance and exit locations for the tunnel are summarized in Scenario 1, the E-R concept, and Scenario 3, the Ladegårdsåen Extension.

4.7.5. [Inclusion of Parking](#)

Parking at Rådhuspladsen has been included in this scenario for the same reasons that it was included in the Ladegårdsåen Extension.

4.7.6. [Pros and Cons of the Y-Connection](#)

| Pros | Cons |
|--|---|
| Diverts through-traffic under and around city center | Reduces green space at southern exit |
| Does not surface in Amager Fælled | Cost increase to build two tunnels |
| Can incorporate Ladegårdsåen surface design for the appropriate portion | Construction of intersection of tunnels is complicated |
| Provides parking in central Copenhagen | Adds traffic to a congested intersection at southern exit |
| Services Nordhavn | - |
| Services Refshaleøen | - |
| Completes city ring | - |
| Could provide parking at DR Byen in the future | - |

Table 19 – Pros and Cons of Y-Connection

The Y-Connection diverts traffic from the city center by putting it underground and provides parking and a connection to the Metro under Rådhuspladsen in central Copenhagen. The construction of this tunnel allows the city to complete the daylighting of the Ladegårdsåen canal and creates more green space in Nørrebro. This plan contributes to congestion at its southern exit. The intersection of Sjaellandsbroen, Artillerivej, and Vejlands Allé is already busy and experiences some of the worst traffic on the island of Amager. This exit complicates the situation by adding more traffic and another road connection. In addition, building two intersecting tunnels makes the project more expensive and more complicated at their intersection.

4.8. Scenario 6 – Y-Connection by Field’s Shopping Center

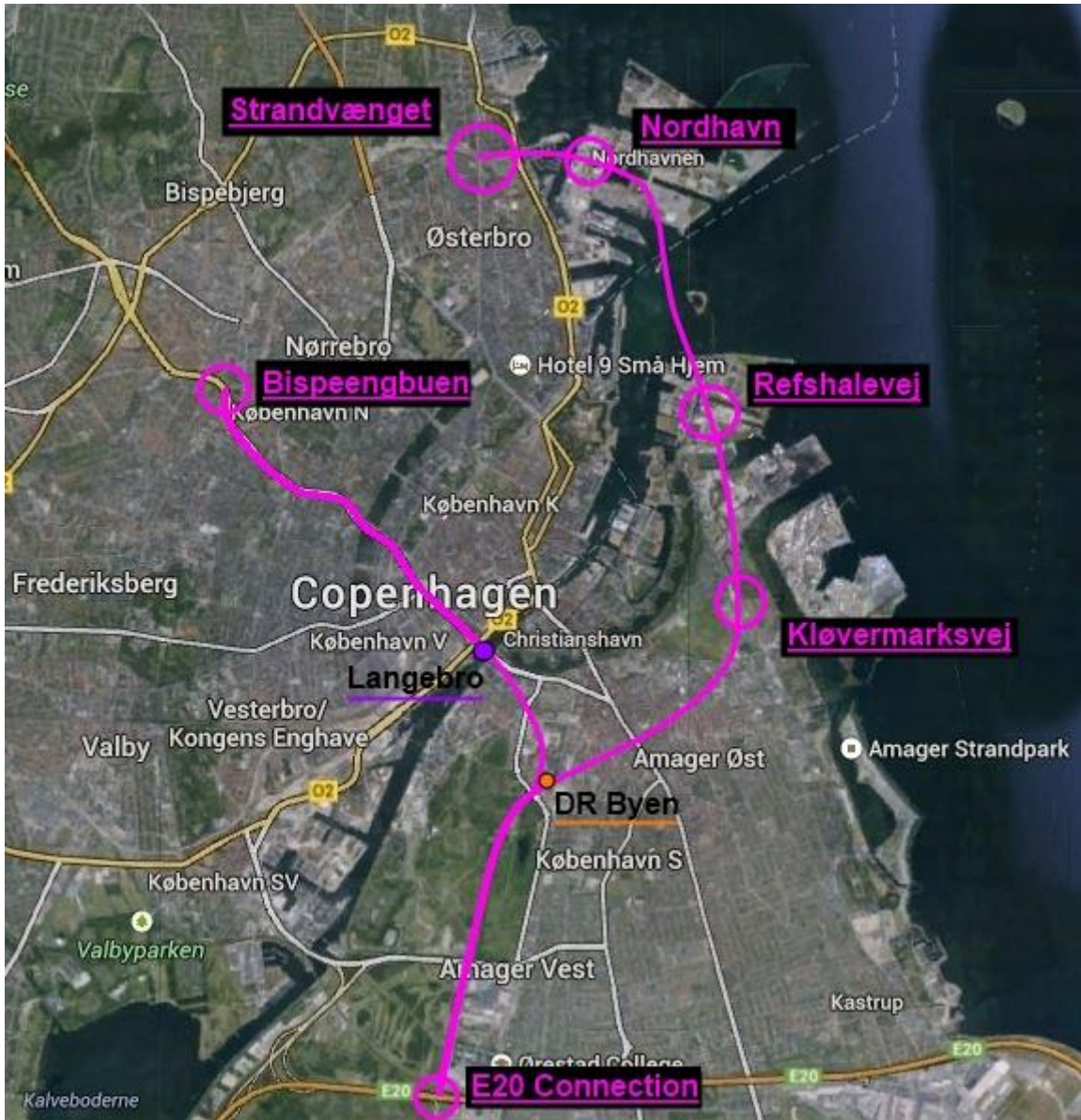

Figure 50 – Y-Connection by Field’s Route Highlighted on a Satellite Image

4.8.1. Y-Connection by Field's Shopping Center Overview

| | |
|---|--|
| Entrance and Exit Locations | <ul style="list-style-type: none"> • North: Strandvænget (an extension of Nordhavnsvej) and Bispeengbuen at Borups Place • In Ydre Nordhavn • Refshalevej on Refshaleøen • At Forlandet / Kløvermarksvej north of Kløvermarken • Junction: DR Byen (no exit) • South: E20 west of Fields (possible underground exchange) |
| Tunnel Length | <ul style="list-style-type: none"> • From Strandvænget to E20: 12.8 kilometers • From Bispeengbuen at Borups Place to E20: 9.0 kilometers • Total: 18.5 kilometers |
| Maximum Flood Water Volume (Approx.) | <ul style="list-style-type: none"> • From Strandvænget to DR Byen: 304,487 cubic meters • From Bispeengbuen at Borups Place to DR Byen: 182,308 cubic meters • From DR Byen to E20: 104,267 cubic meters • Total: 591,064 cubic meters |
| Estimated Driving Time at 90 km/h | <ul style="list-style-type: none"> • From Strandvænget to E20: 8.5 minutes (12.8 km) • From Bispeengbuen to E20: 6 minutes (9.0 km) |
| Estimated Driving Time at 110 km/h | <ul style="list-style-type: none"> • From Strandvænget to E20: 7 minutes (12.8 km) • From Bispeengbuen to E20: 4.9 minutes (9.0 km) |
| Tunnel Junctions | Limited exchange at DR Byen |
| Parking Locations | At Rådhuspladsen |

Table 20 – Y-Connection by Field's Overview

4.8.2. Reasoning behind Y-Connection by Field's Route

The Y-Connection is the basis for the Y-Connection by Field's, except that the exit is at the E20. This avoids surfacing in Amager Fælled and similar to the Y-Connection has a junction near DR Byen.

4.8.3. Thought behind the Traffic Flow

The traffic flow for the Y-Connection by Field's is similar to the Y-Connection (Scenario 5), except that the traffic will flow to the E20 rather than to both the O2 and the E20 as discussed in the Y-Connection. This plan services people looking to travel to and from Sweden, and people traveling to and from Ørestad.

4.8.4. Entrance and Exit Locations

The entrance and exit locations for the tunnel are summarized in Scenarios 2 and 4, the E-R and the Ladegårdsåen routes, respectively, with connection to the E20.

4.8.5. Inclusion of Parking

Parking at Rådhuspladsen has been included in this scenario for the same reasons that it was included in the Ladegårdsåen Extension.

4.8.6. [Pros and Cons of Y-Connection by Field's](#)

| Pros | Cons |
|--|---|
| Diverts through-traffic under and around city center | May reduce green space at southern exit |
| Does not surface in Amager Fælled | Cost increase to build two tunnels |
| Can incorporate Ladegårdsåen surface design for the appropriate portion | Construction of intersection of tunnels is complicated |
| Provides parking in central Copenhagen | Possible underground connection to E20 could be expensive |
| Services Nordhavn | May cause objections to an exit's construction at the edge of the Royal Golf Center |
| Services Refshaleøen | - |
| Completes city ring | - |
| Could provide parking at DR Byen in the future | - |

Table 21 – Pros and Cons of Y-Connection by Field's

This tunnel has the same benefits as the Y-Connection, but instead of connection at the Sjaellandsbroen/Vejlands Allé intersection, it connects at the E-20 by Field's Shopping Center. The Y-Connection by Field's disturbs some green space with the construction of the southern exit, but there is already construction there. The Royal Golf Center is also next to the proposed exit, which may cause objection by users and owners of the center.

4.9. Scenario 0 – No Tunnels

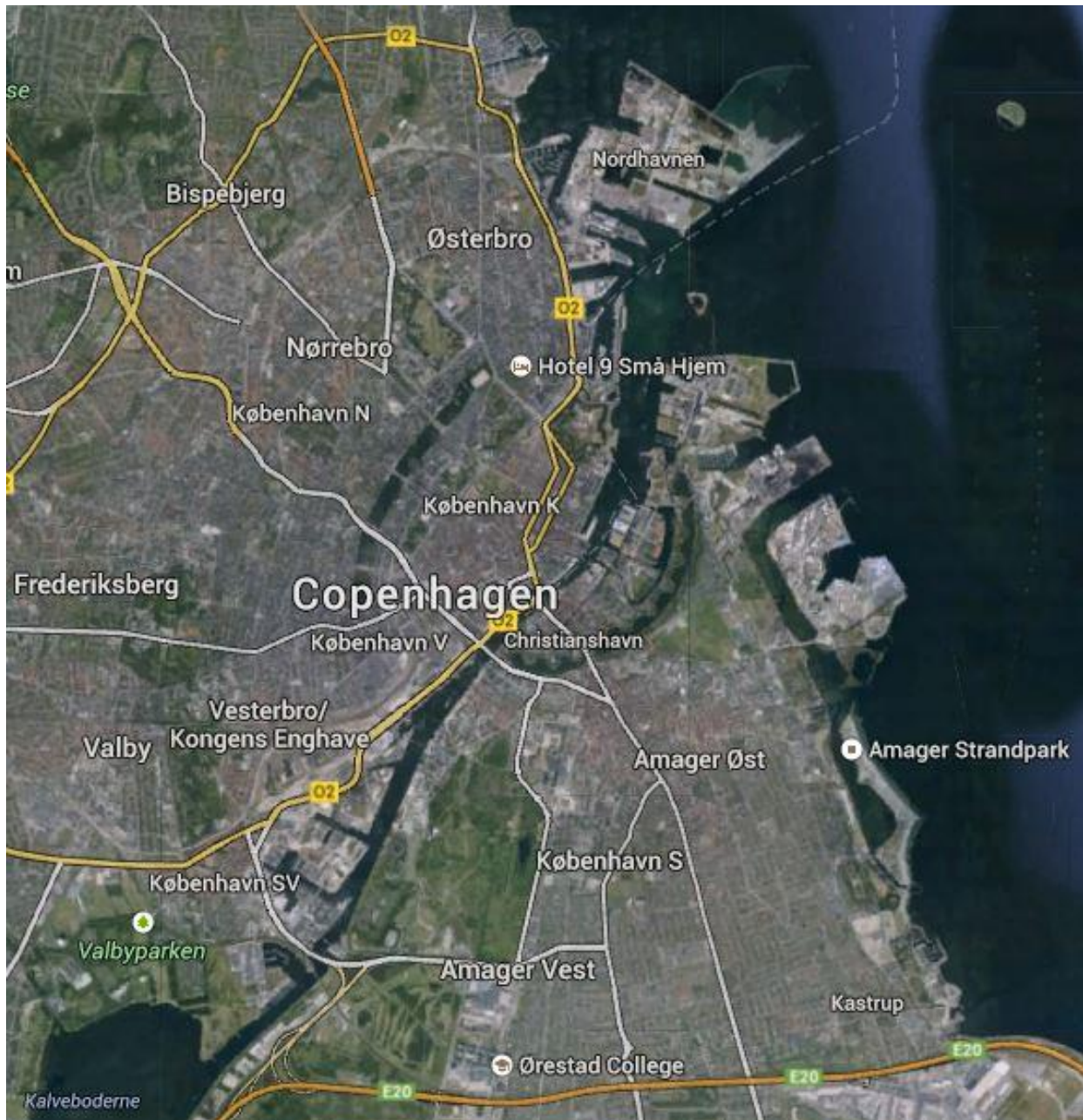

Figure 51 – Satellite Image of Copenhagen (No Tunnel)

4.9.1. [Scenario 0 Overview](#)

| | |
|---|----------------|
| Entrance and Exit Locations | None |
| Tunnel Length | 0 kilometers |
| Maximum Flood Water Volume (Approx.) | 0 cubic meters |
| Estimated Driving Time at 90 km/h | - |
| Estimated Driving Time at 110 km/h | - |
| Tunnel Junctions | None |
| Parking Locations | None |

Table 22 – No Tunnels Overview

4.9.2. [Reasoning behind having No Tunnels](#)

Scenario 0 focuses on a plan where no tunnels exist. A no-tunnel scenario is important to consider by illustrating what the other tunnel scenarios are providing and whether it is better or worse than a situation with no tunnels.

The creation of Metro stations in the harbor developments would service future residents. Bicycles are also a viable option for residents of the harbor developments. Two options to consider without a tunnel are how to service the harbor developments, and how to reduce traffic in central Copenhagen. Section 4.12.2 provides an in depth description of servicing the harbor developments. Section 4.12.1 discusses traffic reduction within the city center by use of tolls.

4.9.3. [Pros and Cons of Scenario 0](#)

| Pros | Cons |
|--|---------------------------------|
| No money spent on building a tunnel | Must find a solution to traffic |
| Green space is preserved | Does not service Nordhavn |
| | Does not service Refshaleøen |

Table 23 – Pros and Cons of No Tunnel Scenario

4.10. Maps & Data

The WPI project team used a wide variety of maps and data provided by the municipality of Copenhagen in order to achieve a better understanding of where viable routes may be constructed and whether a tunnel would solve the traffic problem or add to it. Water volume calculations, flooding zones, tunnel construction, and traffic estimations were considered in the maps and data that are provided below.

4.10.1. [Volume Calculation](#)

As requested by Anders Jensen, one of the team's early assignments was to calculate the maximum water storage capacity of each tunnel for use during cloudburst situations. We used a sketch (based on the cross section provided in Transportministeriet's "Østlig Ringvej København" report from 2013) made in Dassault Systemes's SolidWorks 2012 to calculate the approximate area of each possible water-holding section of the tunnel. The shaded light blue portions of the cross section below (see Figure 52) currently have no use, or the report did not detail the use. Instead, the water-holding calculations use these empty sections for water storage (and the light blue signifies that water is present). The volume of the tunnel is the product of the combined areas and the total length of the tunnel (calculations shown in Table 30).

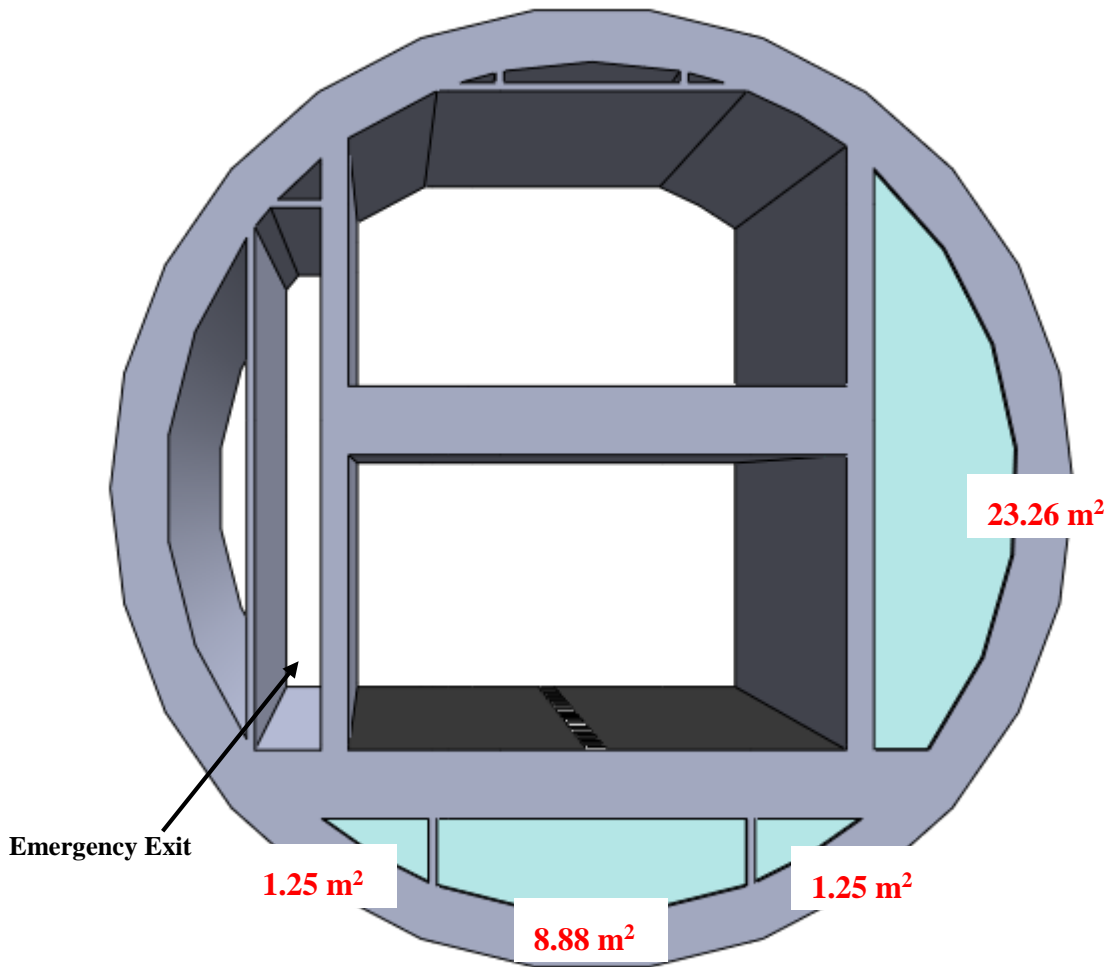

Figure 52 - Tunnel Cross-Section Sketch based on the Cross-Section in Rambøll's "Østlig Ringvej København"

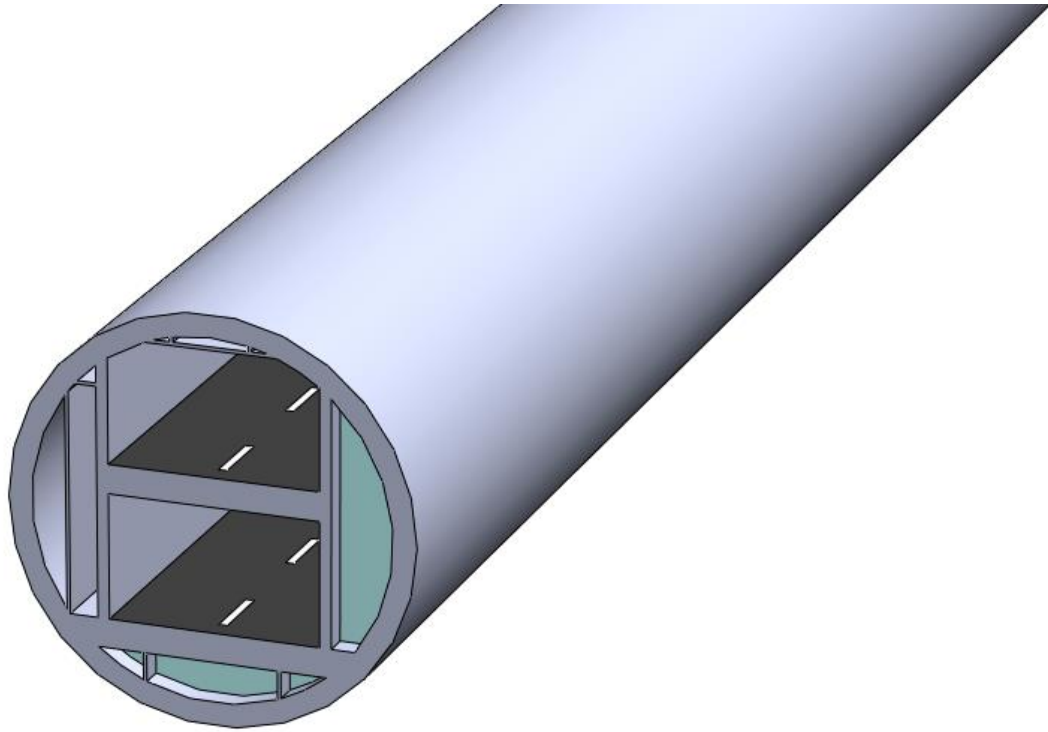

Figure 53 – 3D Model of Extruded Tunnel Profile

4.10.2. Flooding zones

Based on the interview with Mr. Fink of HOFOR, the project team realized that Amager has no concentrated flooding zones (zones where water pools due to topography and impermeable materials). Amager is relatively flat and many areas experience flooding. Because the land slopes very little, the floodwater does not easily drain to a single location, creating a difficult drainage situation. Figure 54, provided by Mr. Fink during his interview, indicates concentrations of flood-prone areas on Amager with red circles.

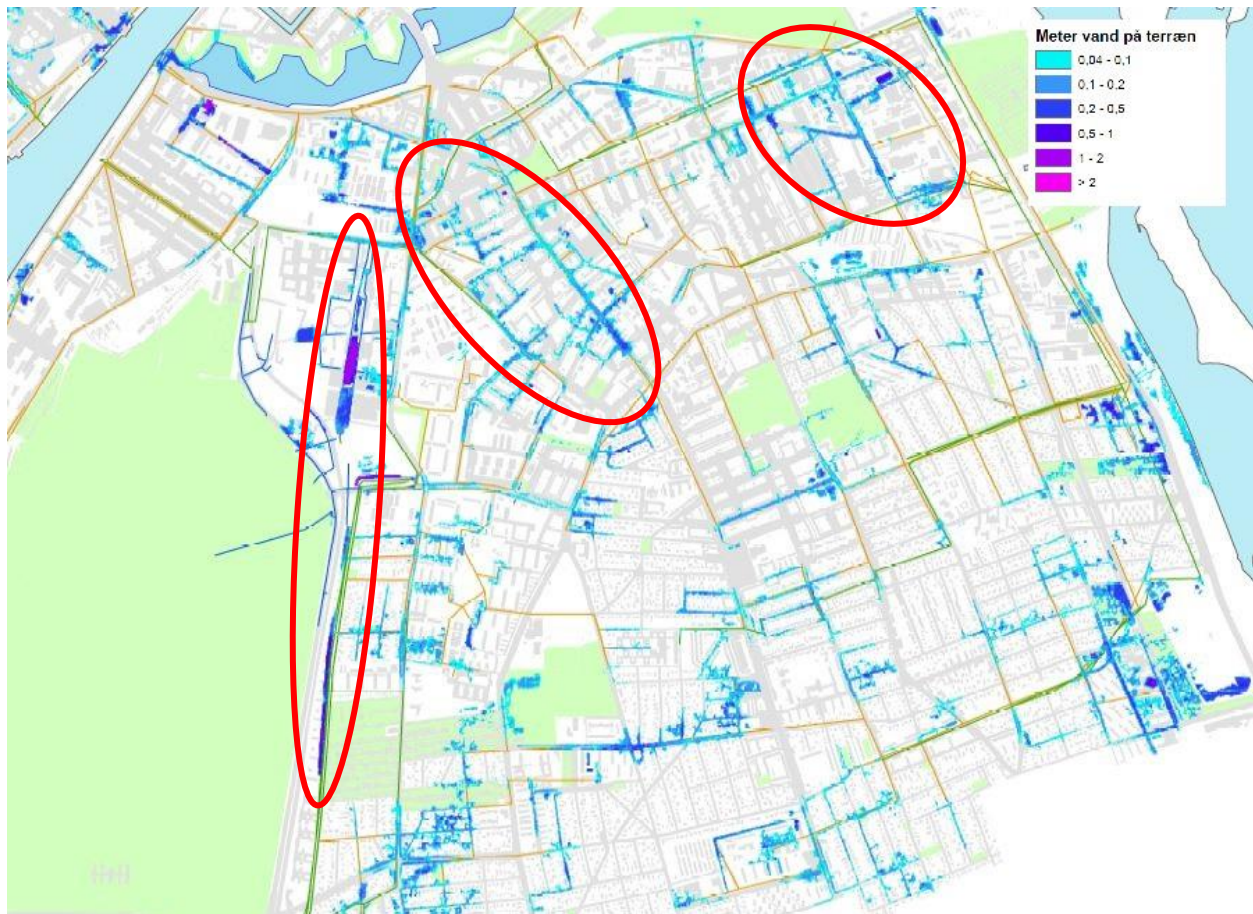

Figure 54 – Flooding Map of Amager with Flood Zones

Based on this map, one of the main areas of flooding is along the eastern side of Amager Fælled. A canal, designed to collect extra water during storms, services this zone, which is why the flooding occurs along a single strip. The other two areas of flooding identified are not as focused and would require a spread out water collection system in order to service the entire zone. Mr. Fink asserted that a tunnel would not be able to provide a solution that would be as efficient as the multiple cheaper projects that HOFOR has planned.

4.10.3. [Traffic Estimation](#)

Table 24 is a traffic demand model provided by Anders Jørn Jensen. The numbers reflect the predicted number of cars passing the specified point for each of the scenarios identified at the top of the table. The first column provides a numerical comparison for the other scenarios listed and demonstrates the current traffic conditions. The second column is a numerical description of the

expected traffic counts in 2032 if nothing is done. This corresponds to the WPI IQP team's Scenario 0. The third column contains predicted traffic counts for the Eastern Ring Road, and it corresponds to Scenario 1. These numbers are expected to be similar to Scenario 2 (Eastern Ring Road by Field's Shopping Center), as the only difference between the scenarios is the placement of the southern exit. The fourth column, corresponding to Scenario 5 (Y-Connection), contains predicted traffic counts for the Y-Connection tunnel including a parking garage at Rådhuspladsen. These numbers can also be used for Scenario 6 (Y-Connection by Field's Shopping Center), as once again, the difference between Scenarios 5 and 6 is the placement of the southern exit. In both cases of the similarity between Scenarios 1 and 2 and Scenarios 5 and 6, the traffic numbers are not expected to change much despite the different exit locations. The second, third, and fourth columns are all numbers generated for the year 2032. A preliminary analysis done by Anders Jørn Jensen for Miljøpunkt Nørrebro provided these numbers and Table 24 has been adapted with his permission for use in this project. Traffic predictions were not included for Scenarios 3 (Ladegårdsåen Extended Tunnel) or 4 (Ladegårdsåen Extended Tunnel by Field's Shopping Center) as these scenarios could not be related to any work done previously by Mr. Jensen, and would have been too costly to acquire for this project.

| | Traffic Counts (2012) | Traffic Predictions without tunnels - Scenario 0 (2032) | Traffic Predictions with E-R - Scenario 1 (2032) | Traffic Predictions with Y-Connection Scenario and Parking at Rådhuspladsen - Scenario 5 (2032) |
|-------------------------------------|-----------------------|---|--|---|
| HC Andersens Blvd. at Rådhuspladsen | 72800 | 76300 | 62400 | 40500 |
| Langebros (Bridge) | 70900 | 99800 | 76200 | 60200 |
| Knippelsbro (Bridge) | 32700 | 45200 | 32700 | 30700 |
| In Tunnel at Rådhuspladsen | 0 | 0 | 0 | 54200 |
| E-R at Nordhavn | 0 | 0 | 64900 | 58900 |
| E-R under Amager | 0 | 0 | 38600 | 35800 |
| E-R at Sjøllandsbro | 52900 | 65600 | 63600 | 57700 |

Table 24 - Traffic Demand Model (Miljøpunkt Nørrebro Preliminary Traffic Research 2012)

4.10.4. Tunnel Construction

The team suggests the use of tunnel boring machines (TBMs) to build the tunnel. They are expensive machines to operate, but they significantly reduce the impact of construction on the environment and the residents of the areas the tunnel passes through. Cut-and-cover construction

produces dust and traffic in the area. Cut and cover construction requires the route of the tunnel to be dug up and creates visual disturbances to the community. The construction sites are also sources of noise pollution if they are open. Combined, these negative impacts on the community outweigh the cost of using a TBM. TBMs cost about two billion Danish Kroner per kilometer of construction. The use of a single, larger machine to drill a single tunnel shaft is more cost efficient than two smaller machines for two tunnel shafts. This, summarized in Table 25, was determined by previous studies by the Danish Ministry of Transport (Transportministeriet, 2013), and published in their proposal, “Østlig Ringvej København”.

| ID | Crossing the Port Channel | Crossing Refshaleøen | Crossing Under Amagerbro | Crossing Amager Fælled | Estimated Cost |
|-------------|----------------------------------|-----------------------------|---------------------------------|-------------------------------|-----------------------|
| B4 | Drill 2 X Ø13 meters | Cut & Cover | Drill 2 X Ø13 meters | Cut & Cover | 30 billion DKK |
| L1-A | Drill 2 X Ø10.2 meters | Cut & Cover | Drill 2 X Ø10.2 meters | Cut & Cover | 20 billion DKK |
| L1-B | Drill 1 X Ø15.5 meters | Cut & Cover | Drill 1 X Ø15.5 meters | Cut & Cover | 20 billion DKK |
| L2 | Sunken tunnel | Cut & Cover | Drill 2 X Ø10.2 meters | Cut & Cover | N/A |
| L3 | Sunken tunnel | Road Terrain | Drill 2 X Ø10.2 meters | Road Terrain | N/A |

Table 25 – Overview of the Studied Alternative Project Designs by Rambøll

Scenario B4 is two bored tunnels with diameters of 13 meters each, and both tunnels include an emergency lane. Scenario L1-A is two bored tunnels with diameters of 10.2 meters and does not include emergency lanes. Scenario L1-B is a single bored tunnel of 15.5 meters diameter. Constructing two stories of traffic decks within the same tunnel separates traffic in opposite directions. This single tunnel would cost around 20 billion Danish Kroner as compared to the original 30 billion estimated for Scenario B4. The designers eliminated scenarios L2 and L3 from consideration because they are too detrimental to the environment and the saved cost is not worth the damage they would cause. After comparing the financial costs and impacts each method of tunnel construction would have on the community, it was determined that Scenario L1-B was the best option for the Eastern Ring Road. We have chosen to suggest the same tunnel

shaft design for all our possible tunnel scenarios.

TBMs perform best when operated in a uniform material. The majority of Copenhagen rests on a chalk layer that begins around 10 meters underground. This is a stable and appropriate construction material for boring. The Metro runs as deep as 30 meters below the surface. Our tunnels will need to pass under the Metro to avoid intersections. We have chosen the deepest portion of our tunnels to be no deeper than 40 meters to satisfy this restriction. The maximum acceptable slope of tunnels is 3.5%, or 35 meters of elevation change per 1000 meters of horizontal travel ("H C Andersens Boulevard," 2008; "Tunnel under Åboulevarden," 2013). Our tunnels are long enough that we can reach our maximum depth without exceeding the maximum acceptable slope. Since the boring machines cannot bore to a shallower depth than 10 meters without leaving the chalk layer, we expect that entrances and exit will have to be built by cut-and-cover method ("H C Andersens Boulevard," 2008). The maximum acceptable slope dictates that the cut-and-cover sections will have to be around 350 meters in length before boring can begin in the chalk.

4.11. Survey

To gauge public opinion, the team surveyed people at Amagerbro Torv, near the Amager Centret shopping center on Friday April 2 between 2 PM and 3 PM and on Saturday April 3 between 1 PM and 3 PM. A total of 35 people answered the survey. The survey gave participants the option not to answer a question if they did not want to. Some questions during the survey allowed participants to give multiple answers. The survey focused on five distinct topics: demographics, current activity in Copenhagen, Public awareness of traffic projects in Copenhagen, Amager Fælled, and Metro construction. The project did not use the survey in the analysis of the tunnel scenarios, except in solidifying the team's own ranking of tunnel aspects for Copenhagen, seen later in Section 4.15.4.

4.11.1. Demographics of Survey Participants

The survey (see Appendix B) asked 14 questions in total. The first four questions consisted of demographics questions, which helped the team evaluate the responses and note areas of interest. The location of surveying was between a metro station, bike racks, and car parking, all located next to a shopping center. The team picked this location to receive a variety of responses, not necessarily representing the population of Amager or Copenhagen overall. The most important

demographics were age, home district, and participant’s form of daily commute. The results of all four demographic questions are included in Table 26. The age distribution favored the younger population, specifically people 18-34 years old. 65% of the people taking the survey were younger, which is due to the topic of the survey. A common response from elderly people was that they would not be around to see the results of any project undertaken by the municipality. In addition to having younger participants, 69% of all participants were local residents of Amager East and West. This was likely because the location was in Amager, though there were responses from other districts of Copenhagen, including Nørrebro and Indre By. The last question in demographics asked, “How do you commute daily?” and participants could provide multiple responses which yielded 53 responses overall. The most notable discrepancy in this question was the overwhelming lack of car users. Only three participants used a car to commute daily, however other participants may have still owned cars even though they did not use them for their daily commute. The results showed that most participants, 46%, used the Metro and the S-Tog, followed by cycling, 32%, as the next closest form of travel. Considering the high level of transit users and cyclists, the team was able to determine the interests of a group that would not use the tunnel daily.

| Question | Number of Responses | Percentages |
|-----------------|---------------------|-------------|
| AGE | n = 35 | |
| 18-24 | 11 | 31% |
| 25-34 | 12 | 34% |
| 35-44 | 6 | 17% |
| 45-54 | 5 | 14% |
| 55-64 | 1 | 3% |
| 65+ | 0 | 0% |
| GENDER | n = 35 | |
| Male | 26 | 74% |
| Female | 9 | 26% |
| DISTRICT | n = 35 | |
| Østerbro | 0 | 0% |
| Nørrebro | 2 | 6% |
| Indre By | 2 | 6% |
| Vesterbro | 0 | 0% |

| | | |
|-----------------------|---------------|-----|
| Christianshavn | 1 | 3% |
| Amager Øst | 15 | 43% |
| Amager Vest | 9 | 26% |
| Other | 6 | 17% |
| DAILY COMMUTE | n = 53 | |
| Car | 3 | 6% |
| Bicycle | 17 | 32% |
| S-Tog | 10 | 19% |
| Metro | 13 | 25% |
| Walking | 5 | 9% |
| Other | 5 | 9% |

Table 26 – Demographics of Survey Participants

4.11.2. Current Activity in Copenhagen

The second portion of the survey asked participants three questions about construction and traffic congestion in Copenhagen. Question 5 on the survey asked, “How do you feel about the construction in Copenhagen currently?” The survey provided participants five responses and allowed multiple answers to this question, resulting in 38 responses. The results (see Figure 55) show that most people believe “Construction is for a good cause, so I am okay with it” or they do not care about the construction. Only 26% believed it was too loud, disruptive, or they were not okay with it. This question adds perspective of the public’s opinion on construction. The result is a positive outlook on construction, which leads the team to believe that if the public is aware of the purpose of construction projects, then they will be content with it.

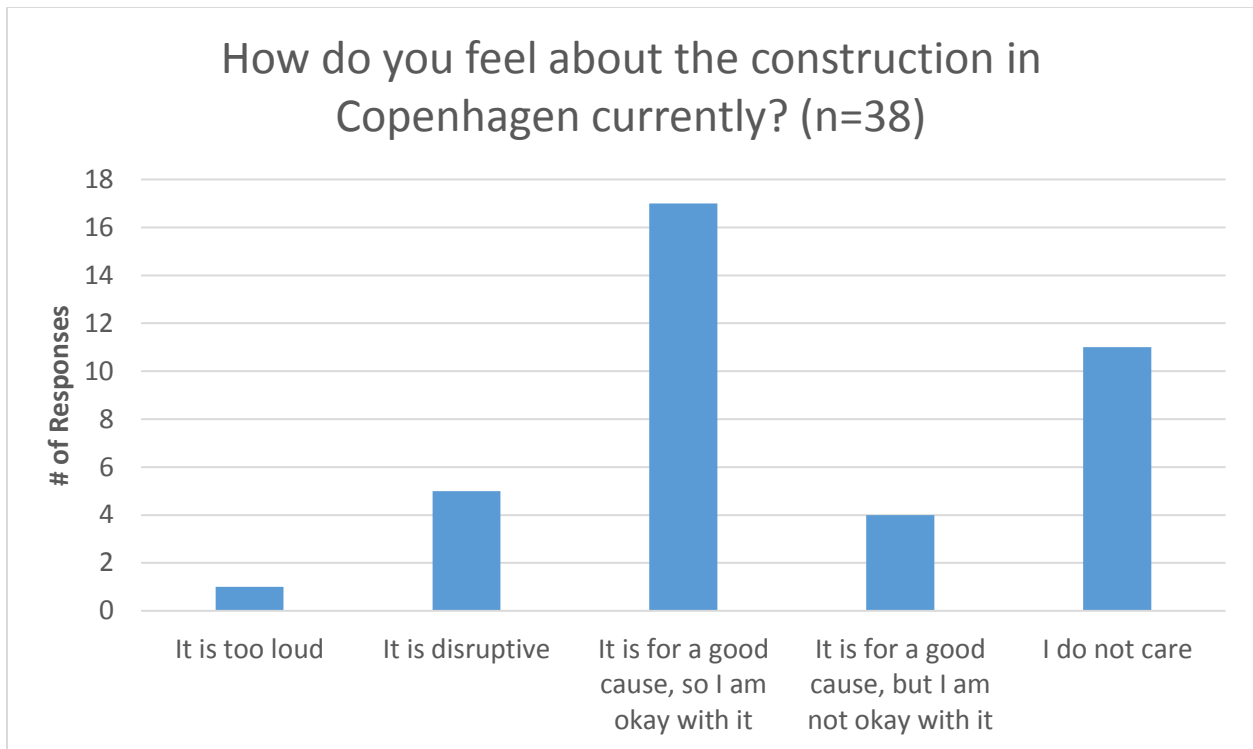

Figure 55 – Responses to “How do you feel about the construction in Copenhagen currently?”

Question 7 asked participants to rate traffic congestion in Copenhagen on a scale of 1 (No problems) to 5 (It is horrible). Responses, as seen in Figure 56 were mostly that “It is congested at times” with even distribution about and below this response. The average rating for this question was 3.1. This solidifies the team’s understanding that Copenhagen has a noticeable amount of traffic congestion.

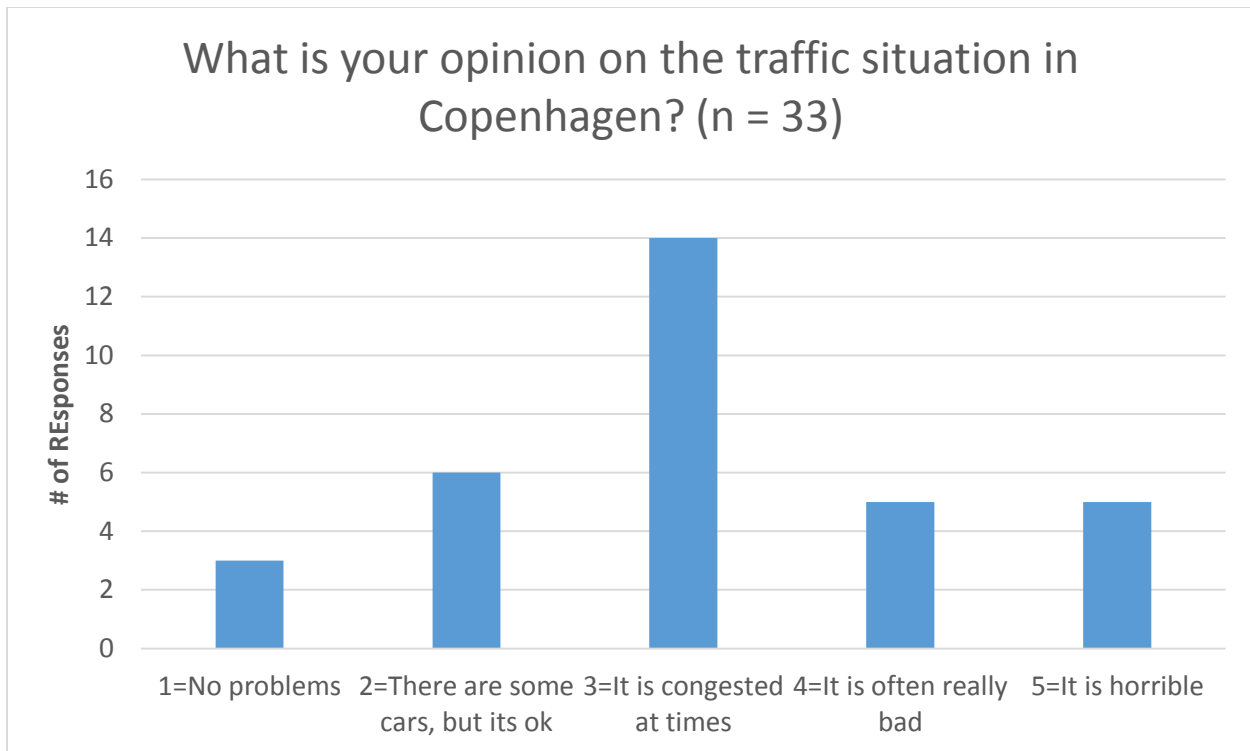

Figure 56 – Responses to “What is your opinion on the traffic situation in Copenhagen?”

4.11.3. Public Awareness

The Public Awareness section of the survey contained two questions and shed light on the participants’ knowledge of traffic projects in Copenhagen. Question 8 asked whether they knew about the Eastern Ring Road, the Ladegårdsåen Tunnel (referring to the 2012 WPI IQP Project), or Other (included a portion to fill in own response). After receiving all the responses shown in pie section of Figure 57, the team decided that the “Other” option provided no good feedback and replaced it with a “Neither: option upon analysis. The survey results showed participants knew about the Ladegårdsåen the least, which the team determined to be the result of many participants being from Amager and therefore not having much knowledge of a project in Nørrebro. Only one participant, a resident of Nørrebro, had known about both projects. Question 9 then followed up by asking the participants how they felt about the traffic projects they had heard of on a scale of 1-3 (1= not in favor, 2= neutral, 3= in favor). As a result of the minimal awareness of the Ladegårdsåen, the team only analyzed favorability of the E-R. Of the 18 responses (see breakdown of E-R in Figure 57) that were aware of the E-R, only one participant was not in favor of it. The mean favorability of the E-R was 2.3. The team referenced “Providing Support for the Ladegårdsåen Daylighting Project”, written by a WPI IQP team working with

Miljøpunkt Nørrebro in 2014, in order to determine the favorability of the Ladegårdsåen Tunnel. The 2014 IQP team surveyed 30 people in Nørrebro, 23 of which lived there. The team asked members of the community if they had heard of the Ladegårdsåen Tunnel project, if the participant had not the team then explained the project to them and then asked how the participant how they felt about the project. Only 40% of the 30 participants had heard of it, but 67% had liked the idea after they had heard of it. After analysis of this section and the work done in “Providing Support for the Ladegårdsåen Daylighting Project”, the team deduced that public awareness is an important aspect of favorability when talking about traffic projects.

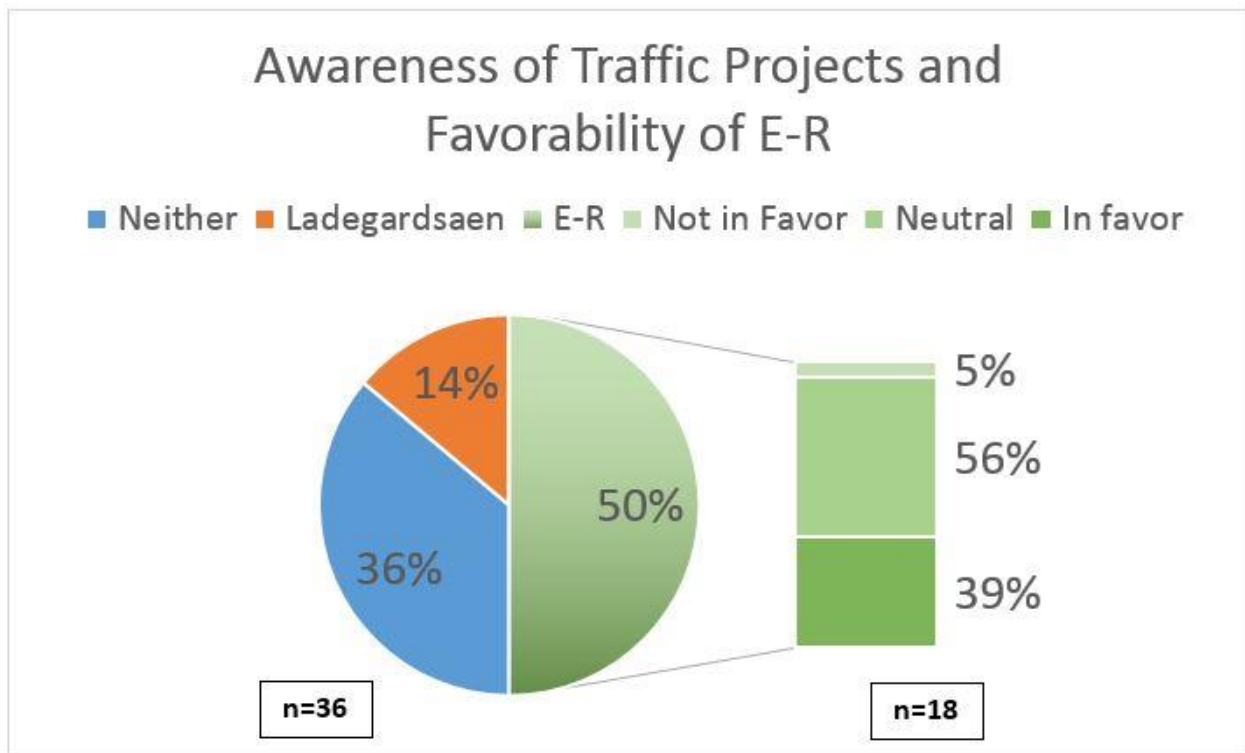

Figure 57 – Awareness of Traffic Projects and Favorability of E-R

4.11.4. [Amager Fælled](#)

The Amager Fælled portion of the survey contained three questions about Amager Fælled and possible construction in the Fælled. Question 10 directed participants to select the statement that most exemplified their feelings about Amager Fælled. Results (see Figure 58) showed that 26 people had positive opinions of Amager Fælled. Of the remaining nine participants, five of them did not use the Fælled so they did not have an opinion. The results of this question reinforced the team’s knowledge of Amager Fælled as a popular natural green space. The discussion with Ms. Rasmussen brought up the importance of the fact that Amager Fælled was not a well-maintained

park and was mainly natural. Through the survey, the team determined that people enjoy Amager Fælled as it is, while a substantial group also wants it to be more organized.

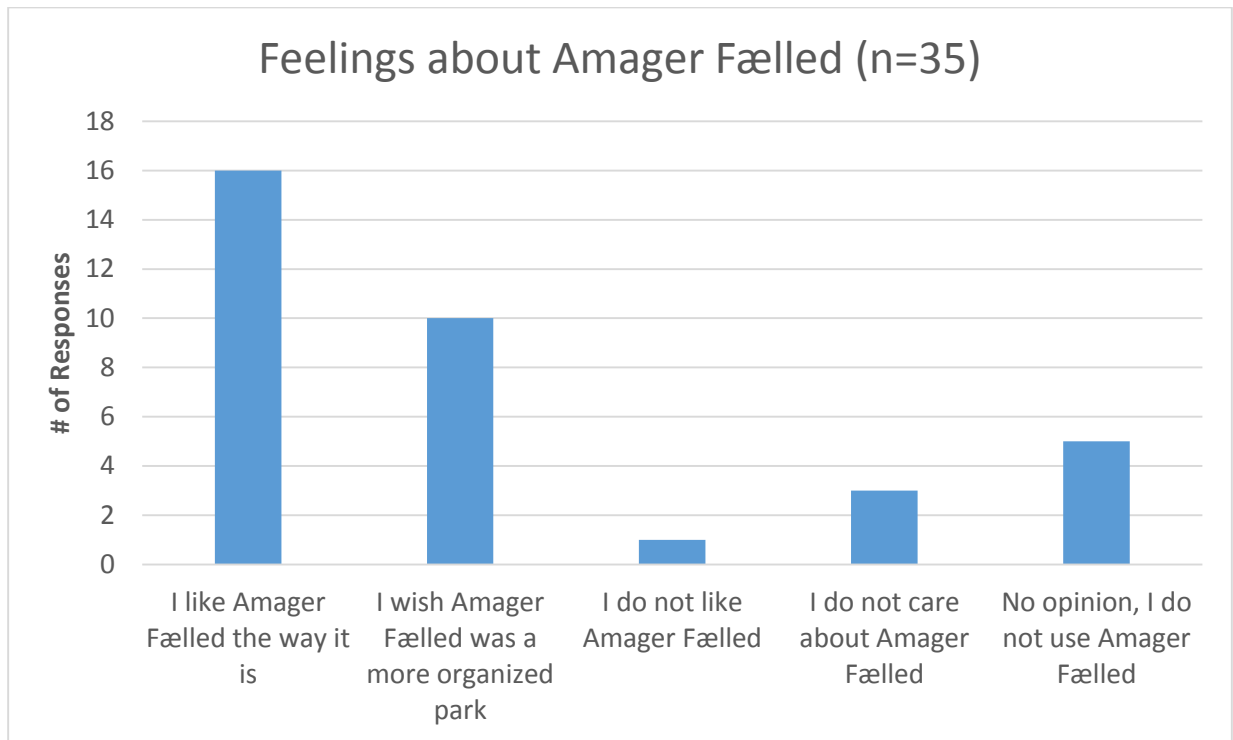

Figure 58 – Summary of Respondents’ Feelings about Amager Fælled

Question 11 judged how people would feel if a traffic project used up part of Amager Fælled. The answers offered were, “I would be angry”, “I would not care” or “I would like it”. Many participants instructed that they would not be angry, but instead “disappointed”. The team instructed these participants to respond as angry. The majority of the 35 respondents said that they would be angry/disappointed about traffic projects using the Fælled. This section showed the importance of Amager Fælled and emphasized the inclusion of preservation of green space in analysis of the tunnel scenarios.

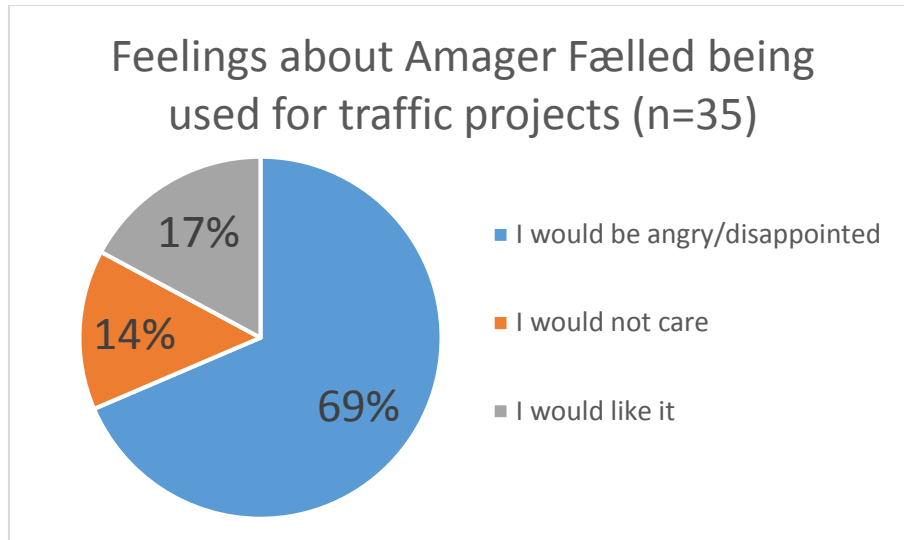

Figure 59 – Respondents’ Feelings about Amager Faelled Being used for Traffic Projects

4.11.5. [Metro Connection](#)

The final section of the survey asked questions about underground parking and possible connection to the Metro from underground parking. Question 13 on the survey asked if having underground parking for cars connected to the Metro would increase their interest in building a tunnel. 60% of participants responded yes, as seen in Figure 60. However, in the follow-up, Question 14, when asked if they would use the parking, most participants answered that they would not (see Figure 61). The team concluded that because of the large number of cyclists and people who use public transit, they would not be as likely to use the underground parking, but as long as it is for a good cause than they approve of the underground parking.

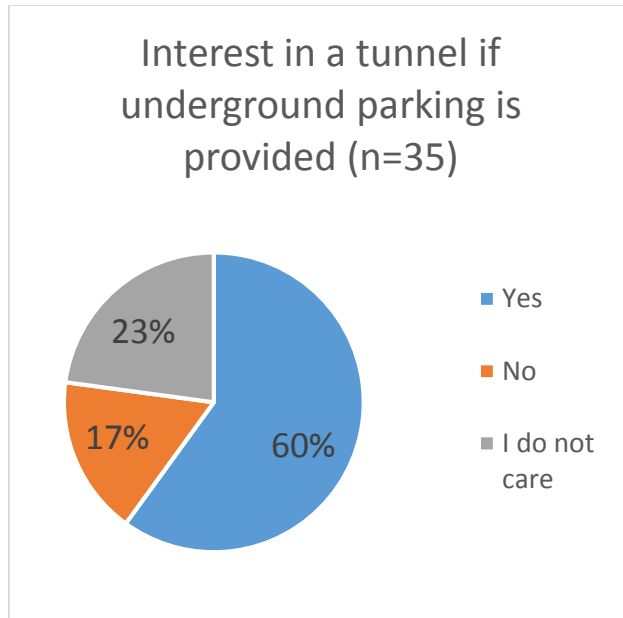

Figure 60 – Respondents’ Interest in a Tunnel if Underground Parking is Provided

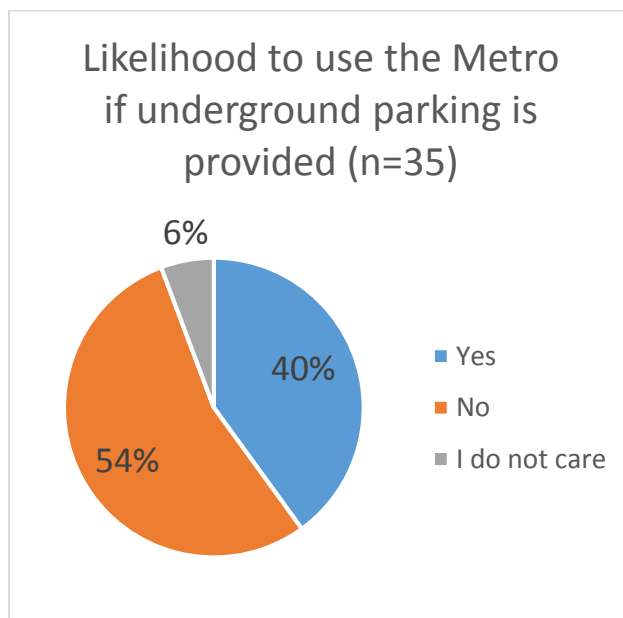

Figure 61 – Respondents’ Likelihood to use the Metro if Underground Parking is Provided

4.11.6. [Conclusions drawn from Survey](#)

The results of the survey did not change any of the team’s opinions, but instead reinforced what the team learned through the expert interviews and their time in Copenhagen. The team learned that public awareness is a vital part of determining the favorability of the tunnel. It was unimportant how the cyclists commuted daily, but instead the participants answered based on what the tunnel would do for the city. Finally, the survey provided the team with a basis of how the younger generation feels about the tunnel. The younger generation is the generation that will

see the outcome of any future projects undertaken by the city, so it is important to know that they know about, and like the traffic projects that the municipality accepts.

4.12. Additional Service to the Harbor Developments

While the Eastern Ring Road plans to service the harbor developments of Nordhavn and Refshaleøen, it is critical that Copenhagen sends the message to its residents that cars will not be the primary form of transportation. It is necessary for there to be car access to the harbor developments, but in order to send this message, the city needs to put the proper public transportation infrastructure in place. One such strategy is the addition of a Metro line that acts as a finger and extends out to each of the developments. The M4 line seen Figure 62 will service Nordhavn, but it is currently under construction. The questions then become “is a Metro line adequate to service Nordhavn?” and “how does Copenhagen service Refshaleøen?”



Figure 62 - Complete CPH Metro Directory

4.12.1. Servicing Nordhavn

With the M4 connecting Nordhavn to Østerport and the E-R connecting it to Amager and Østerbro, the residents utilizing public transportation will simply need to walk to the Metro station. The longest projected walking distance for a resident is between 1 km and 1.5 km. With the average walking speed of a human being around 5 kilometers per hour, the longest walk to the Metro station would take between twelve and eighteen minutes.

This is reasonable but can become inconvenient on a daily basis. An alternative to walking to the Metro is riding a bicycle. However, one of the downfalls of using a bicycle to get to the Metro is that the user cannot take it on the Metro during rush hour. Fortunately, riders can lock their bicycles and leave them at a bike rack until they return from work or their destination. Encouraging the citizens to cycle to the Metro will reduce their travel time (for a 1-1.5 kilometer distance) to between approximately four and six minutes⁵. This is a more feasible time to expect commuters to spend traveling to the Metro and encourages an active lifestyle.

4.12.2. Servicing Refshaleøen

Since it is possible to service Nordhavn with just the E-R and M4 Metro line, it is also possible to service Refshaleøen in a similar manner. To service it by the Metro, another line will need to be established. Since all of the Metro lines run through Kongens Nytorv, it is practical to run the hypothesized line through it as well. The new line would then run east through Marmorkirken with the M3 and M4, and finally out to Refshaleøen. In the other direction, the Metro line would follow the M4 back to København H, which is also a practical stopping point since the M4 services the other harbor development. If a Metro line serviced Refshaleøen, its small size would make the station close to residents who would commute daily by Metro.

4.12.3. Affordable Public Transportation for Harbor Development Residents

One of the common complaints about public transportation when talking to Copenhageners is that although the city is pushing heavily for public transit to be a primary form of transportation, it is expensive. The up-front cost is not large, the standard Rejsekort pass is approximately 80 DKK with a mandatory 100 DKK the user is required to put on it upon purchase. Each time someone scans the Rejsekort, deducts the fee for transport from the card's balance. Therefore, while the initial cost of the pass is only 180 DKK, the small fees to travel add up long term.

One method of encouraging Nordhavn and Refshaleøen's future residents to use public transportation is to incorporate a discounted public transportation pass and discounted travel rates. The residents, because of their location on a peninsula in the harbor, are already going to have high taxes. If these taxes increase slightly to cover the cost of the transportation discount, the city of Copenhagen will not lose money on it. Since people have a natural tendency to look at

⁵ Average bicycling speed is approximately 15.5 km/h

the end cost, the final sum of money they have to pay, a small increase to their property taxes to account for public transportation discounts may go unnoticed or may be too small for them to care. The residents will get their discounted public transportation, green harbor living location, and service from the E-R. This complete coverage of both car access and public transportation, with incentives to use public transportation, should satisfy residents on all sides of the “car vs. public transportation vs. cycling” debate, while encouraging them to choose green alternatives to cars.

4.13. Implementing a Congestion Ring in Copenhagen

4.13.1. Background of the Toll Situation in Copenhagen

One area of concern when considering traffic reduction was tolls. Tolls in the tunnel are unappealing, but the municipality has considered tolls surrounding the city on the surface in the past. The report, *Traffic in Copenhagen* (2009), stated, “Together with a number of other municipal authorities in the Metropolitan region, the City of Copenhagen has for a number of years been looking into the possibilities of setting up a system with a payment ring.”

The Socials Democrats and the Socialist People’s Party, in order to reduce motor traffic in the city by 40% and raise money to reinvest in public transportation, proposed a congestion-charging zone around Copenhagen. 130,000 hours of work are lost to traffic at a cost of seven billion in lost earnings, according to the two parties. The tolls would generate two billion Danish Kroner, approximately 370 million US dollars, which would be put towards reducing public transportation by upwards of 40%. In 2011, a congestion charge looked inevitable, but ministers in Denmark shot down the proposal in 2012 (Buley, 2012). The prime minister’s Liberal Party stated that the charge would create barriers, reduce mobility, and would be an extra tax on the motorists (who already pay three registration charges). Another concern of the Liberal Party was of the capabilities of buses and trains; the capacity of trains and buses are already pushed to the limits, where people are forced to stand. It would also affect commuters who drive in and out of Copenhagen daily and don’t have an alternative to driving (Walsh, 2011).

4.13.2. Surface Tolls vs. In-Tunnel Tolls

One of the biggest questions when discussing the implementation of tolls is deciding whether they should be placed above ground or in the tunnel. Denmark’s Ministry of Transport recently published a document called “Transportministeriet – Supplerende trafikanalyser for Østlig

Ringvej” (Tetraplan A.S, 2013), which details that if 20 DKK tolls are enforced on cars and 80 DKK tolls are enforced on trucks, fifty percent fewer cars will travel on the toll road. This statistic shows that tolls discourage drivers from using the toll roads. Therefore, tolls implemented in a traffic tunnel discourage commuters from using the tunnel, leading to more traffic on surface roads. This eliminates in-tunnel tolls from the discussion and directs focus to surface tolls. Toll on surface roads around the city will discourage commuters from driving through Central Copenhagen and encourage them to find an alternative route, such as a tunnel under the city.

4.13.3. [The London Congestion Zone: A Model for Copenhagen to Follow](#)

In an attempt to reduce the amount of congestion, major cities, including London, Milan, and Stockholm, have implemented congestion charges. The most successful of them, London, commenced in February of 2003 (London, 2010). The tolls exist, as seen in Figure 63, along the Inner Ring Road of London and contain the City of London, measuring an area of eight square miles and about 136,000 residents (BBC, 2003).

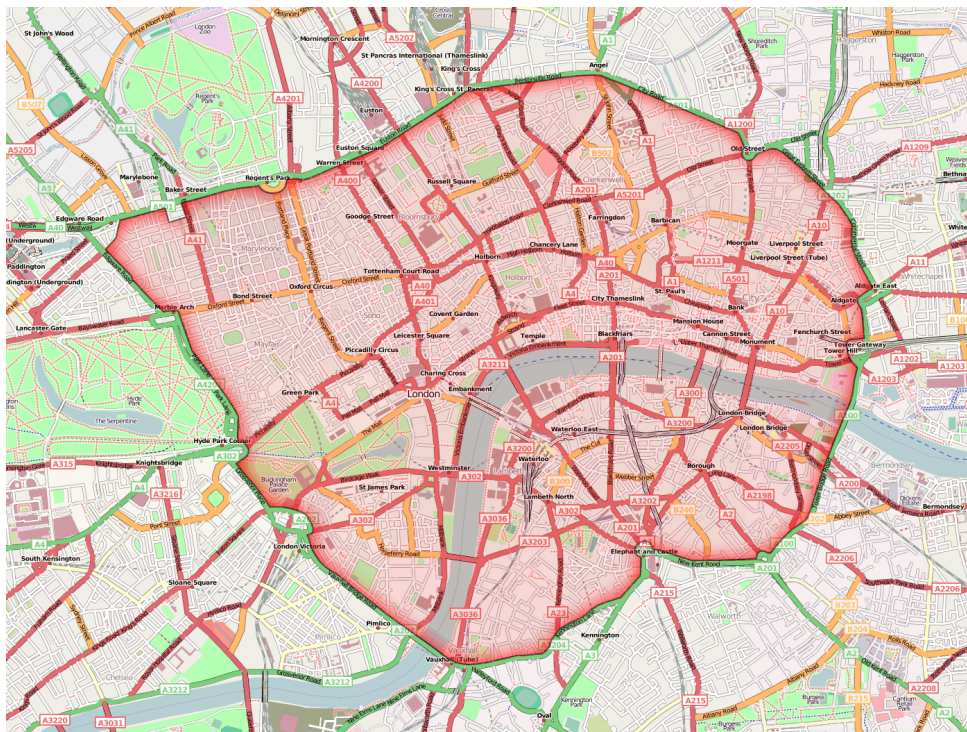

Figure 63 – London Congestion Charge Zone

The zone operates from 7:00 AM to 6:00 PM on weekdays, excluding holidays. A network of cameras read license plates as drivers enter, drive around, and leave the zone. The daily charge is

£10 if paid in advance or on the day of transit, and £12 if paid a day after. That is about \$16 and \$20, respectively to enter the zone daily. There is an Ultra Low Emission Discount (ULED), which provides a 100% discount for electric vehicles and ultra-low vehicles (vehicles emitting 75g/km or less of CO₂ and meeting the Euro 5 emission standard). There is also a penalty of £130 for not paying the charge. Charges can be paid through SMS, auto pay, phone, post (if done in advance), or online. (Association, 2014).

4.13.4. A Congestion Zone for Copenhagen to Consider

Although the ministers denied possibility of a congestion charge for Copenhagen in the past, it is one of the most effective ways to reduce traffic within the city center. The creation of a toll around the city center, as seen in Figure 64, would create some traffic outside of the ring, but it would ultimately diminish the traffic within the city center. A key factor in the location of the congestion zone and the overall size of it depends on ease of implementation and the purpose of the zone itself.

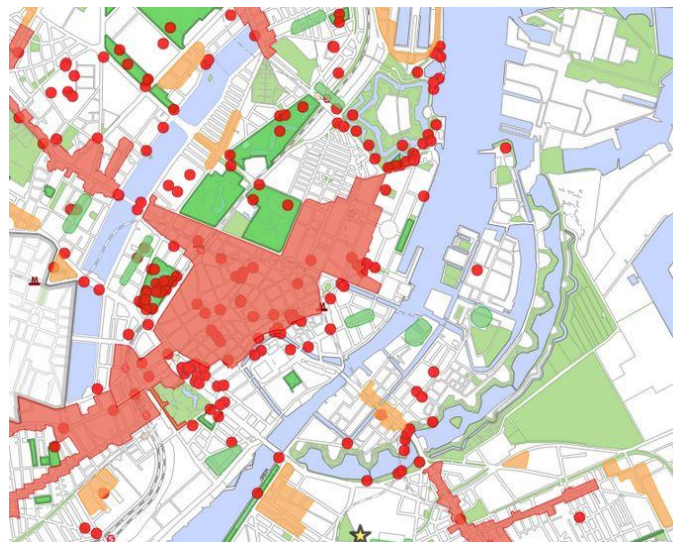

Figure 64 – Map Detailing Retail and Monuments in Copenhagen Center

Figure 64 shows the center of Copenhagen. The congestion zone would primarily divert traffic away from this area. The red shaded area in the map is retail, and the red dots are cultural monuments. It is because of the centralization of both monuments and the retail area that the zone would encompass the area between the lakes and the harbor. The congestion zone contains the largest amount of monuments in Copenhagen as well as Rosenborg Palace Garden, the Botanical Garden, and Kastellet, seen in green shading above, which provide a large amount of green space. The longest pedestrian shopping street in Europe, Strøget, is also in this area, which

is strictly for walking and biking. The street is a common place to find people enjoying the fresh air, shops and various cafes. However, before Strøget was explicitly pedestrian, it had large amounts of traffic congestion and people now take the pedestrian street for granted (personal contact with Anders Jensen, 2014). A congestion charge zone would not permit the creation of an entirely pedestrian area of the city, but it would reduce the number of cars in the area. The city center is a mix of commercial and cultural importance, which should be preserved for the public to enjoy and appreciate without the disturbance of traffic.

Based on the natural barriers and the dense amount of culture and commerce, as explained previously, the team designed two options to compare. The first option, seen in Figure 65, has a congestion zone between the lakes and the harbor. This is the densest area of culture and commerce in Copenhagen, and it uses the lakes and the harbor as natural barriers. There are a limited number of roads into this area already including the six roads next to the lakes, the two bridges across the harbor, and the highly trafficked O2 ring road, which cuts through the center of this area. One of the fears associated with this decision is the isolation of zones cut off by the congestion zone, such as Amager and Christianshavn.

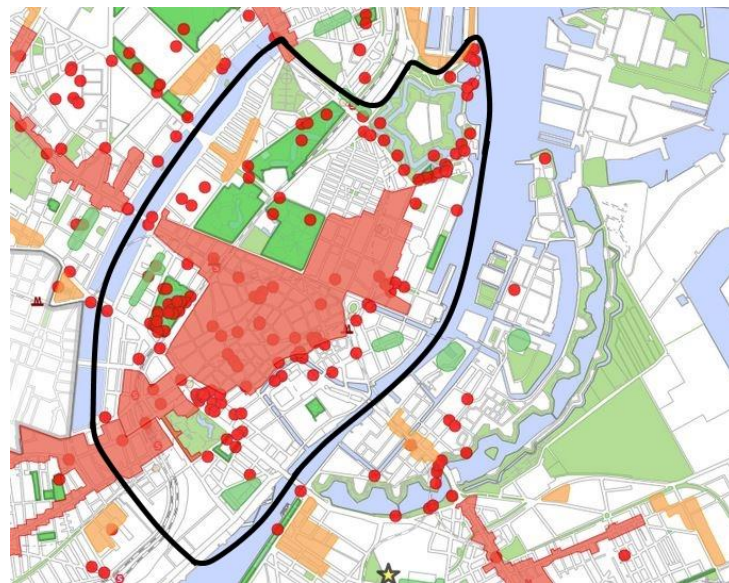

Figure 65 – Proposed Congestion Ring around Copenhagen's City Center (excluding Christianshavn)

The second option, seen in Figure 66, is an adaptation of the first option. The only difference between the two is the inclusion of Christianshavn. Christianshavn has natural borders along the old city's ramparts, which separates it from Amager. These natural borders would reduce, similar to the harbor, traffic if a toll is implemented. The fears with this design are the further isolation

of Christianshavn because the only way onto the island without paying is from within the congestion zone.

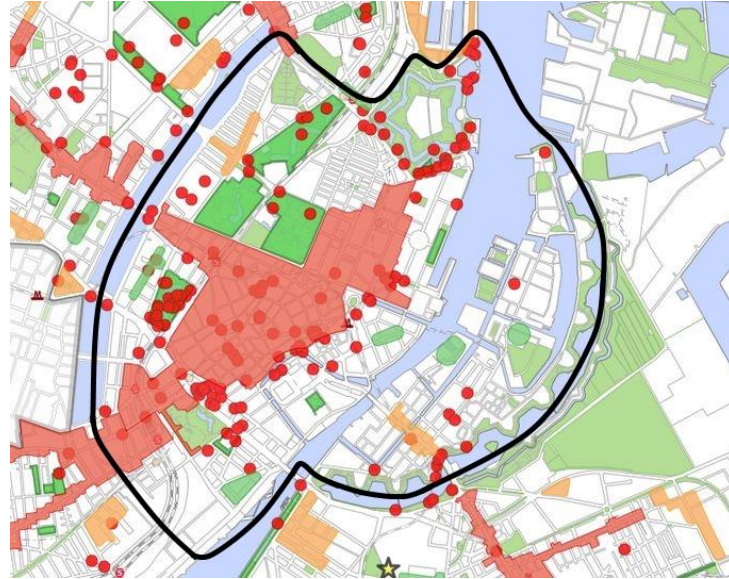

Figure 66 – Proposed Congestion Ring around Copenhagen's City Center (Including Christianshavn)

The team believes that the second option is the better choice. The area chosen reflects the old city when surrounded by the ramparts. The large focus was the retail and monuments in the area, but the size played a role as well. The congestion zone suggested is a preliminary idea that would work well alongside either Y-Connection scenario. The municipality had lobbied for a larger area when first talking about a congestion ring, and they could expand this area in the future if it is successful in the smaller scale that the team suggests.

In terms of logistics regarding the actual tolls, there are several techniques for collecting tolls, including: GPS tracking, radio-frequency identification, license plate identification, and the slowest of all, payment gates. GPS tracking tracks a vehicles location and charges the user for length of use of tolled areas, but people complain that it is an invasion of privacy and can be very costly to implement due to the lack of GPS systems in vehicles. Radio-frequency identification allows users to travel at highway speeds, but requires the implementation of transponders in cars, which can be a huge cost for the user or the toll company and can deter an easy start up. Payment gates are slow and require employees to operate the tollgates. London uses a license plate identification system, which allows the user to drive through the tolls and pay at another time. The license plate identification system is the best choice for a toll system with today's

technology. While GPS would be easiest to track, monitor, and charge, it requires everyone to have GPS in their vehicles, which is difficult to implement.

Hours of operation for the toll system would mirror London's system. When Copenhagen had originally suggested a congestion charge they suggested a 25 DKK fee during rush hours and 10 DKK during non-rush hours and weekends. Compared to London's system, this is much cheaper; however, it runs constantly, whereas the system in London has no charges before 6:00 AM, after 7:00 PM, weekends, or holidays. A combination of the fees suggested by Copenhagen and the hours enacted in London would create a compromise that would benefit the people and create revenue for the municipality to put towards public transportation.

4.13.5. [Incorporation of Super Bicycle Lanes](#)



Figure 67 – Super Bike Paths along Copenhagen's Lakes

A congestion zone limits the amount of cars traveling in the zone and encourages cycling, walking and public transit. In addition to setting up tolls along the second congestion zone option chosen earlier, the redesign of the city can include the renovation of roads for bicycle use only. The yellow lines in Figure 67 are super bike paths. Limiting the bridge along the upper super bike path to non-vehicles reduces the number of tolls, which saves the municipality money. The Ladegårdsåen Extension scenarios remove cars from the bridge below the super bike path creating another non-vehicle bridge, and reducing the tolls by one more. The focus on cycling is something that the team suggests for the entire congestion charge zone, not just the borders.

4.14. Breakdown of the Decision Matrix Weightings

As mentioned in Phase 5 of the Methodology (see Section 3.6), each tunnel scenario passes through a set of evaluation criteria based on trending topics discussed in the expert interviews. This section breaks down the criteria: cost, accessibility, floodwater management, reduced number of surface cars, reduced quantities of air and noise pollution, and the preservation of green space; and all the rankings for each scenario for each category.

4.14.1. [The Cost Calculator Ranking Table](#)

Table 27 and Table 28 (shown below) rank each tunnel scenario from 1 to 7 based on the estimated total cost (1 being the cheapest and 7 being the most expensive). The tables show that the motivating factor behind the cost is the tunnel's length; thus, Scenario 5 and Scenario 6 are the most expensive because they are a combination of two routes: the modified Eastern Ring Road and modified Ladegårdsåen routes. Scenario 3 and Scenario 4 have the shortest lengths (excluding Scenario 0, which has no tunnel) because they extend from Nørrebro to Amager, which is a shorter distance than Østerbro to Amager like in the modified Eastern Ring Road and Y scenarios. Consequently, these two scenarios are also cheaper than the other tunnel scenarios.

Another major expense in building a tunnel is the number of entrances and exits. The transition from tunnel to surface road, in addition to the ramps that connect to the surface road infrastructure, takes approximately 300 to 500 meters. The city then loses millions in kroner from excavating as the construction method switches from boring to cut and cover (to build the entrance/exit ramps). As a result, the scenarios that incorporate the Eastern Ring Road have higher entrance/exit construction costs because they have more locations than the scenarios that incorporate only the modified Ladegårdsåen. While the scenarios are ranked based on cost, note that the Eastern Ring Road proposal (Scenario 1) hovers between twenty and thirty billion DKK. This price is difficult for the Danish taxpayers and government to validate the spending need. In terms of cost, this makes Scenarios 3 and 4 more appealing to Copenhageners.

| Cost | | | |
|---|------------|--------------------|--------------------|
| Name | Scenario 0 | Scenario 1 | Scenario 2 |
| Estimated Total Cost | DKK - | DKK 25,000,450,000 | DKK 25,460,375,000 |
| Rank | 1 | 4 | 5 |
| Percentage | 1.00 | 0.57 | 0.43 |
| Each scenario is ranked from 1-7, 1 being the least expensive and 7 being the most. | | | |
| Direct Costs | | | |
| Name | Scenario 0 | Scenario 1 | Scenario 2 |
| Length (km) | 0.00 | 12.50 | 12.73 |
| Price (2Billion/km) | DKK - | DKK 25,000,000,000 | DKK 25,460,000,000 |
| Number of Entrances/Exits | 0 | 6 | 5 |
| Price | DKK - | DKK 450,000 | DKK 375,000 |
| Price is between 50-100Mil DKK | | | |
| Total | DKK - | DKK 25,000,450,000 | DKK 25,460,375,000 |
| Indirect Costs | | | |
| Name | Scenario 0 | Scenario 1 | Scenario 2 |
| Water Storage in Flood-Prone Areas (cubic meters) | | | |
| Total Water Storage Capacity (cubic meters) | - | 399,800 | 407,156 |
| *Note: The cross section detailed by Ramboll is approximately | | | 32.0 |
| Material Damages due to Water Damage during a Cloudburst (estimated) | DKK - | DKK - | DKK - |

Table 27 – Tunnel Scenario Cost Ranking Table (1 of 2)

| Scenario 3 | Scenario 4 | Scenario 5 | Scenario 6 |
|--------------------|--------------------|--------------------|--------------------|
| DKK 14,400,150,000 | DKK 17,400,150,000 | DKK 34,800,450,000 | DKK 37,000,450,000 |
| 2 | 3 | 6 | 7 |
| 0.86 | 0.71 | 0.29 | 0.14 |
| 7.20 | 8.70 | 17.40 | 18.50 |
| DKK 14,400,000,000 | DKK 17,400,000,000 | DKK 34,800,000,000 | DKK 37,000,000,000 |
| 2 | 2 | 6 | 6 |
| DKK 150,000 | DKK 150,000 | DKK 450,000 | DKK 450,000 |
| DKK 14,400,150,000 | DKK 17,400,150,000 | DKK 34,800,450,000 | DKK 37,000,450,000 |
| Scenario 3 | Scenario 4 | Scenario 5 | Scenario 6 |
| 230,285 | 278,261 | 556,522 | 591,704 |
| square meters | | | |
| DKK - | DKK - | DKK - | DKK - |

Table 28 - Tunnel Scenario Cost Ranking Table (2 of 2)

Another point to consider is that in the costs table (Table 27), the higher construction costs due to a longer tunnel length and more entrance/exit locations have negative connotations. Scenarios 5

and 6 specifically are the most expensive for these reasons. However, factors like having a longer length and a higher number of entrance/exit locations favor these tunnel scenarios in categories like accessibility and the reduction of cars from surface roads.

4.14.2. The Tunnel Accessibility Ranking Table

The accessibility of a tunnel determines the level of difficulty a driver faces when traveling to a tunnel entrance/exit. It plays a pivotal role in the number of cars that enter the tunnel because an entrance that is more difficult to access will discourage drivers from using it; thus proving to be a primary factor in determining how well a tunnel services its community. Table 29 dissects each scenario based on the number of entrance/exit locations a route has and the number of cars the north and south exits funnel through daily. Due to its length and geographic position, scenarios that include the E-R have more entrance/exit locations with the intention of servicing the harbor developments, Nordhavn and Refshaleøen. On paper, this statistic makes the modified E-R and Y connection scenarios more accessible than the modified Ladegårdsåen scenarios. When examined more closely though, the Y connections stand alone because with two north entrance/exit locations, the commuters projected to use either the modified Ladegårdsåen or E-R tunnels are both satisfied.

| Accessibility | | | | | | | |
|--|-------------|------------------------------------|-------------------------|------------------------------------|------------------------|------------------------------------|-------------------------|
| Name | Scenario 0 | Scenario 1 | Scenario 2 | Scenario 3 | Scenario 4 | Scenario 5 | Scenario 6 |
| Number of Entrances/Exits | 0 | 6 | 5 | 2 | 2 | 6 | 6 |
| Rank | 7 | 1 | 4 | 5 | 5 | 1 | 1 |
| North Entrance Location 1 | None | Strandvaenget, Osterbro | Strandvaenget, Osterbro | Borups Place, Norrebro | Borups Place, Norrebro | Strandvaenget, Osterbro | Strandvaenget, Osterbro |
| Number of Cars expected to pass through daily | 0 | 55,000 | 55,000 | 65,000 | 65,000 | 55,000 | 55,000 |
| North Entrance Location 2 | None | None | None | None | None | Borups Place, Norrebro | Borups Place, Norrebro |
| Number of Cars expected to pass through daily | 0 | 0 | 0 | 0 | 0 | 65,000 | 65,000 |
| Rank | 7 | 5 | 5 | 3 | 3 | 1 | 1 |
| South Entrance Location | None | Sjællandsbroen and Amager Motorway | E20 west of Field's | Sjællandsbroen and Amager Motorway | E20 west of Field's | Sjællandsbroen and Amager Motorway | E20 west of Field's |
| Number of Cars expected to pass through daily | 0 | 55,000 | 55,000 | 55,000 | 55,000 | 55,000 | 55,000 |
| Rank | 7 | 1 | 1 | 1 | 1 | 1 | 1 |
| Number of Cars expected to pass through Nordhavn daily in 2032 | 0 | 64,900 | 64,900 | 0 | 0 | 58,900 | 58,900 |
| Rank | 5 | 1 | 1 | 5 | 5 | 3 | 3 |
| Combined Accessibility Ranking | 6.50 | 2.00 | 2.75 | 3.50 | 3.50 | 1.50 | 1.50 |
| Percentage | 0.21 | 0.86 | 0.75 | 0.64 | 0.64 | 0.93 | 0.93 |

Table 29 – Tunnel Accessibility Ranking Table

An interesting statistic from Table 29 is the number of cars expected to pass through Nordhavn

daily. Scenarios 1, 2, 5, and 6 all include the first segments of the Eastern Ring Road. However, Scenarios 1 and 2 (which are the E-R and modified E-R), service more cars to Nordhavn than Scenarios 5 and 6 (the Y scenarios). Why is that? One plausible reason is that with only an E-R variation in place, commuters traveling from Amager to somewhere between Østerbro and Nørrebro are forced to pass through Nordhavn. However, with the Y scenarios, commuters have the option to take the fork to Nørrebro if they need to get somewhere between Nørrebro and Østerbro. This means that fewer cars would pass through Nordhavn in Scenarios 5 and 6, negatively reflecting their accessibility ranking in the category. These are plausible reasons for the difference in numbers, but the number of variables active are too high to narrow it down to a singular reason.

4.14.3. [The Floodwater Management Ranking Table](#)

| Floodwater Management | | | | | | | |
|---|-------------|-------------|-------------|--------------------|-------------|-------------|-------------|
| Name | Scenario 0 | Scenario 1 | Scenario 2 | Scenario 3 | Scenario 4 | Scenario 5 | Scenario 6 |
| Length (km) | 0.00 | 12.50 | 12.73 | 7.20 | 8.70 | 17.40 | 18.50 |
| Total Water Storage Capacity (cubic meters) | - | 399,800 | 407,156 | 230,285 | 278,261 | 556,522 | 591,704 |
| Rank | 7 | 4 | 3 | 6 | 5 | 2 | 1 |
| Percentage | 0.14 | 0.57 | 0.71 | 0.29 | 0.43 | 0.86 | 1.00 |
| *Note: The cross section detailed by Ramboll is approximately | | | | 32.0 square meters | | | |

Table 30 – Tunnel Floodwater Management Ranking Table

Table 30 shows the approximate floodwater holding capacities of each tunnel scenario. It details that, because the cross sectional area does not change from scenario to scenario, a tunnel’s length is the primary variable in determining the total volume (termed “total water holding capacity” in the table). This means that while length negatively affects the direct (upfront) cost of a tunnel, it positively affects the indirect costs (future costs due to side effects of a tunnel’s design) by reducing the severity of material damages due to flooding. Hence, why Scenarios 5 and 6 rank in the bottom two for cost and are the top two scenarios for floodwater management.

4.14.4. [The Number of Reduced Cars per Scenario per Major Traffic Artery](#)

The number of cars reduced from surface roads depends largely on a tunnel’s accessibility. A tunnel that is more accessible encourages more commuters to drive through it daily, consecutively removing those cars from surface roads. Table 31 compiles this information and data from Miljøpunkt Nørrebro’s preliminary traffic analysis (see Table 24) to determine how many cars each tunnel scenario removes from the Langebro Bridge, H.C. Andersens Boulevard,

and the north/south entrance/exit locations.

| Cars & Pollution | | | | | | | |
|---|-------------------|-------------------|-------------------|-------------------|-------------------|-------------------|-------------------|
| Name | Scenario 0 | Scenario 1 | Scenario 2 | Scenario 3 | Scenario 4 | Scenario 5 | Scenario 6 |
| <i>Number of Cars on Road on H.C. Andersens Blvd. in 2012</i> | | | 76,300 | | | | |
| <i>Length of H.C. Andersens Boulevard (km)</i> | | | 1.30 | | | | |
| <i>Number of Cars Reduced by 2032</i> | 0 | 13,900 | 13,900 | 21,900 | 21,900 | 35,800 | 35,800 |
| <i>Rank</i> | 7 | 5 | 5 | 3 | 3 | 1 | 1 |
| <i>Number of Cars on Langebro Bridge in 2012</i> | | 99,800 | | | | | |
| <i>Number of Cars Reduced by 2032</i> | 0 | 23,600 | 23,600 | 10,000 | 10,000 | 39,600 | 39,600 |
| <i>Rank</i> | 7 | 3 | 3 | 5 | 5 | 1 | 1 |
| <i>Number of Cars Placed Underground by North Entrance 1</i> | 0 | 55,000 | 55,000 | 65,000 | 65,000 | 55,000 | 55,000 |
| <i>Number of Cars Placed Underground by North Entrance 2</i> | 0 | 0 | 0 | 0 | 0 | 65,000 | 65,000 |
| <i>Number of Cars Placed Underground by South Entrance</i> | 0 | 55,000 | 55,000 | 55,000 | 55,000 | 55,000 | 55,000 |
| <i>Total # of Cars Passing thru Entrance/Exit Locations</i> | 0 | 110,000 | 110,000 | 120,000 | 120,000 | 175,000 | 175,000 |
| <i>Rank</i> | 7 | 5 | 5 | 3 | 3 | 1 | 1 |
| Average Overall Rank | 7.0 | 4.3 | 4.3 | 3.7 | 3.7 | 1.0 | 1.0 |
| Overall Weighted Percentage | 0.14 | 0.52 | 0.52 | 0.62 | 0.62 | 1.00 | 1.00 |

Table 31 – Number of Reduced Surface Cars Ranking Table

Scenario 5 and 6 again, because they are more accessible, funnel more cars underneath the city than any other scenario. However, they also remove the most cars from the Langebro Bridge and H.C. Andersens Boulevard. It is plausible that the reason these scenarios remove more traffic than Scenarios 3 and 4 (the modified Ladegårdsåen tunnels) from the selected roads is because the combination of entrances and exits along the route provides commuters with other ways to their destination. Commuters traveling to the area between Nørrebro and Østerbro have the option to take either the left fork (Ladegårdsåen segment) or the right fork (E-R segment), thereby reducing the number of commuters who need to use the surface roads like H.C. Andersens Boulevard.

4.14.5. The Reduced Quantities of Air and Noise Pollution

The amount of reduced air and noise pollution correlates directly to the number of cars reduced from surface roads (Quality, 2011). This means that Scenario 5 and Scenario 6, which are tied for having the best average ranking in Table 31 and funnel the most cars under the city, also reduce air and noise pollution more than any other scenario listed. The reason being is that they have more major (north and south) entrance/exit locations (three as opposed to two like the

others). There are simply more opportunities for cars to travel through the tunnel, which means more cars travel through and pollution drops at a higher rate.

The average gasoline-fueled vehicle on the roads emits approximately 423 grams of carbon dioxide per mile (EPA, 2012). Driving through the longer E-R based portion of Scenario 6 equates to 5.4 kilograms of carbon dioxide. Similarly, Scenario 6 reduces the number of cars travelling on H.C. Andersens Boulevard by 35,800 cars per day. Over the 1.3-kilometer road, that equates to approximately 19,686 kilograms of carbon dioxide not emitted.

4.14.6. [Table Reflecting the Amount of Green Space Preserved](#)

| Preservation of Green Space | | | | | | | |
|--|-------------|-------------|-------------|-------------|-------------|-------------|-------------|
| Name | Scenario 0 | Scenario 1 | Scenario 2 | Scenario 3 | Scenario 4 | Scenario 5 | Scenario 6 |
| <i>Number of Green Spaces Affected</i> | 0 | 2 | 2 | 1 | 1 | 3 | 2 |
| <i>Rank</i> | 1 | 4 | 4 | 2 | 2 | 7 | 4 |
| <i>Total Green Space Area Affected (square meters)</i> | 0 | 364 | 161 | 85 | 44 | 341 | 181 |
| <i>Rank</i> | 1 | 7 | 4 | 3 | 2 | 6 | 5 |
| Combined Rank | 1.0 | 5.5 | 4.0 | 2.5 | 2.0 | 6.5 | 4.5 |
| Percentage | 1.00 | 0.36 | 0.57 | 0.79 | 0.86 | 0.21 | 0.50 |

Table 32 – Preservation of Green Space Ranking Table

The preservation of green space is a critical component of improving Copenhagen’s livability and its chances of becoming the world’s first carbon neutral city by 2025. However, while Scenarios 5 and 6 score well in categories like accessibility, floodwater management, and the number of surface cars reduced from the city center, they perform poorly in the preservation of green space category because there is more construction involved. More specifically, Scenario 1, 5, and 6 have six entrance/exit locations. This equates to more cut and cover construction for the ramps leading into the tunnel; hence, the construction destroys more green space in the process.

4.15. Comparison of the Tunnel Scenarios through using Decision Matrices

4.15.1. Nis Fink's Decision Matrix

This section explains the reasoning behind each contributors ranking system. These are not reasons provided by the contributors, but instead by the team. The team hypothesized the contributors reasons for ranking the aspects based on the interactions that the team had with them and their occupation.

Weight Allocation (out of 100 total possible points)

- 28.6 points – Cost
- 23.8 points – Reduced Number of Surface Cars
- 19.0 points – Reduced Air and Noise Pollution
- 14.3 points – Floodwater Management
- 9.5 points – Preservation of Green Space
- 4.8 points – Accessibility

| Nis Fink | | | | | | | | |
|--|--------------------|-------------|-------------|-------------|-------------|-------------|-------------|-------------|
| Categories | Calculated Weights | Scenario 0 | Scenario 1 | Scenario 2 | Scenario 3 | Scenario 4 | Scenario 5 | Scenario 6 |
| <i>Cost</i> | 28.6 | 28.6 | 16.3 | 12.2 | 24.5 | 20.4 | 8.2 | 4.1 |
| <i>Accessibility</i> | 4.8 | 1.0 | 4.1 | 3.6 | 3.1 | 3.1 | 4.4 | 4.4 |
| <i>Floodwater Management</i> | 14.3 | 2.0 | 8.2 | 10.2 | 4.1 | 6.1 | 12.2 | 14.3 |
| <i>Reduced # of Surface Cars</i> | 23.8 | 3.4 | 12.5 | 12.5 | 14.7 | 14.7 | 23.8 | 23.8 |
| <i>Reduced Air and Noise Pollution</i> | 19.0 | 2.7 | 10.0 | 10.0 | 11.8 | 11.8 | 19.0 | 19.0 |
| <i>Preservation of Green Space</i> | 9.5 | 9.5 | 3.4 | 5.4 | 7.5 | 8.2 | 2.0 | 4.8 |
| Total | 100.0 | 47.3 | 54.4 | 53.9 | 65.6 | 64.3 | 69.7 | 70.4 |

Table 33 – Nis Fink's (HOFOR) Decision Matrix

1. Tunnel Cost

Reason:

Mr. Fink's choice of making cost the most important aspect of the tunnel stems from statements made during his interview. The team believes that Mr. Fink chose cost to be

the most important because the tunnel is a massive project and if the company that is hired to build the tunnel goes bankrupt, like the company originally hired to make the Harbor Tunnel, then the municipality would have invested a massive amount of money for nothing.

2. Reduced Number of Surface Cars

Reason:

The purpose of the traffic tunnel in general is to reduce the number of cars. When asked about the Ladegårdsåen project, which included solutions to pollution, flooding, and traffic, Mr. Fink responded that the tunnel was primarily a traffic tunnel. While it would provide some assistance in reducing flooding and creating green space, the principal reason for creating the tunnel was to reduce traffic in Nørrebro. Based on this fact it is likely that Mr. Fink chose this as the second most important aspect because reducing cars from the surface is actual purpose of the tunnel.

3. Reduced Quantities of Air and Noise Pollution

Reason:

The team believes there is no obvious reason, based on interactions with Mr. Fink and his occupation that he would have picked reduction of air and noise pollution as the third option. However, he may have picked this aspect based on the overall importance of reducing air and noise pollution, and their dependence on the reduction of cars on the surface.

4. Floodwater Management Capabilities

Reason:

During the team's interview with Mr. Fink, he stated that the tunnel would not effectively solve all of Copenhagen's flooding problems. HOFOR, according to Mr. Fink, would be able to provide flooding solutions at a much lower cost and more effectively than a tunnel could. However, because HOFOR is a flood management company, they would likely seek some solution to the flooding issues that would occur in high rainfall conditions. It is likely because of these reasons that floodwater management was ranked fourth.

5. Amount of Preserved Green Space within the City

Reason:

Part of the solution that HOFOR would provide in dealing with high amounts of rainfall was rain gardens. Mr. Fink informed us that the rain gardens would collect water and prevent flooding. Additionally, when asked if Amager Fælled assisted in the reduction of flooding he stated that it was a marsh and water did not drain well from there so preserving the Fælled, from a floodwater management standpoint would be useless. The team believes that because of the solutions that HOFOR would provide and the lack of assistance that the Fælled provides, Mr. Fink ranked preservation of green space as the second least important aspect of the tunnel.

6. Accessibility of the Tunnel's Entrances/Exits

Reason:

Mr. Fink ranked accessibility last. He explained to us during the interview that because he travels from outside of the municipality of Copenhagen he would likely use western ring roads to get around the city rather than the Eastern Ring Road or the Ladegårdsåen Extension. Mr. Fink also believed that it would be just as fast to travel by his usual manner to Ørestad, as it would be to take either of the tunnels suggested. It is because of this aspect of living outside the municipality that he likely ranked the accessibility of the tunnel as the least important.

4.15.2. Claus Knudsen's Decision Matrix

Point Allocation (out of 100 total possible points)

- 28.6 points – Reduced Number of Surface Cars
- 23.8 points – Reduced Air and Noise Pollution
- 19.0 points – Preservation of Green Space
- 14.3 points – Cost
- 9.5 points – Accessibility
- 4.8 points – Floodwater Management

| Claus Knudsen | | | | | | | | |
|--|---------------------------|-------------------|-------------------|-------------------|-------------------|-------------------|-------------------|-------------------|
| Categories | Calculated Weights | Scenario 0 | Scenario 1 | Scenario 2 | Scenario 3 | Scenario 4 | Scenario 5 | Scenario 6 |
| <i>Cost</i> | 14.3 | 14.3 | 8.2 | 6.1 | 12.2 | 10.2 | 4.1 | 2.0 |
| <i>Accessibility</i> | 9.5 | 2.0 | 8.2 | 7.1 | 6.1 | 6.1 | 8.8 | 8.8 |
| <i>Floodwater Management</i> | 4.8 | 0.7 | 2.7 | 3.4 | 1.4 | 2.0 | 4.1 | 4.8 |
| <i>Reduced # of Surface Cars</i> | 28.6 | 4.1 | 15.0 | 15.0 | 17.7 | 17.7 | 28.6 | 28.6 |
| <i>Reduced Air and Noise Pollution</i> | 23.8 | 3.4 | 12.5 | 12.5 | 14.7 | 14.7 | 23.8 | 23.8 |
| <i>Preservation of Green Space</i> | 19.0 | 19.0 | 6.8 | 10.9 | 15.0 | 16.3 | 4.1 | 9.5 |
| Total | 100.0 | 43.5 | 53.3 | 55.0 | 67.1 | 67.1 | 73.5 | 77.6 |

Table 34 – Claus Knudsen's Decision Matrix

1. Reduced Number of Surface Cars

Reason:

Mr. Knudsen ranked the number of cars removed from surface roads as the most important aspect a tunnel's design because traffic congestion is a major problem facing Copenhagen. It is the primary motivation for this project, and causes additional problems. A reduction of cars on surface roads will diminish the amount of air and noise pollution in the city and allow more surface space for bike and bus lanes or returned to green space.

2. Reduced Air and Noise Pollution

Reason:

It is likely that Mr. Knudsen ranked the reduction of air and noise pollution as the second most important design factor because both types of pollution have widespread effects on the environment and residents' health. He is the center director for Miljøpunkt Amager, an environmental organization, and as such cares about both his community's livability and its impact on the environment.

3. Preservation of Green Space

Reason:

Mr. Knudsen sees green spaces as a way of improving a community's habitability and combating threats to the environment. Access to green spaces can have positive

effects on people's emotional and physical health. Natural ground cover like soil and plants are permeable, whereas road pavement is not, and so natural areas can absorb water and reduce flooding. Planted areas are also better for noise dampening and can process some chemical compounds found in air pollution.

4. Cost

Reason:

Mr. Knudsen ranked cost fourth of the six categories. This is most likely because he is aware that expensive projects are more difficult to have approved and the municipality has struggled with getting funding for similar projects in the past.

5. Accessibility

Reason:

While accessibility of a tunnel is important, it is not an issue that the city is currently struggling with, like traffic and pollution. It also is less of an obvious issue than cost in the creation of a tunnel proposal. Often projects compromise on accessibility to lower construction costs so that the project is more appealing to the taxpayers.

6. Floodwater Management

Reason:

Floodwater management is an important problem in Copenhagen, but it is not a day-to-day occurrence and solutions for the problem can be developed in other ways.

4.15.3. [Anders Jensen's Decision Matrix](#)

Point Allocation (out of 100 total possible points)

- 33.3 points – Reduced Number of Surface Cars
- 26.7 points – Preservation of Green Space
- 20.0 points – Reduced Air and Noise Pollution
- 13.3 points – Cost
- 6.7 points – Accessibility

- *Not Considered* – Floodwater Management

| Anders Jensen | | | | | | | | |
|--|---------------------------|-------------------|-------------------|-------------------|-------------------|-------------------|-------------------|-------------------|
| Categories | Calculated Weights | Scenario 0 | Scenario 1 | Scenario 2 | Scenario 3 | Scenario 4 | Scenario 5 | Scenario 6 |
| <i>Cost</i> | 13.3 | 13.3 | 7.6 | 5.7 | 11.4 | 9.5 | 3.8 | 1.9 |
| <i>Accessibility</i> | 6.7 | 1.4 | 5.7 | 5.0 | 4.3 | 4.3 | 6.2 | 6.2 |
| <i>Floodwater Management</i> | - | - | - | - | - | - | - | - |
| <i>Reduced # of Surface Cars</i> | 33.3 | 4.8 | 17.5 | 17.5 | 20.6 | 20.6 | 33.3 | 33.3 |
| <i>Reduced Air and Noise Pollution</i> | 20.0 | 2.9 | 10.5 | 10.5 | 12.4 | 12.4 | 20.0 | 20.0 |
| <i>Preservation of Green Space</i> | 26.7 | 26.7 | 9.5 | 15.2 | 21.0 | 22.9 | 5.7 | 13.3 |
| Total | 100.0 | 49.0 | 50.8 | 53.9 | 69.7 | 69.7 | 69.0 | 74.8 |

Table 35 – Anders Jensen's Decision Matrix

1. Reduced Number of Surface Cars

Reason:

Anders Jensen selected the reduction of cars using surface roads as the most important design criteria. This choice was likely because he worked on previous projects to reduce car traffic and believes that traffic congestion is a significant problem in Copenhagen.

2. Preservation of Green Space

Reason:

Mr. Jensen also worked for Miljøpunkt Nørrebro, a related environmental organization in the Nørrebro district of Copenhagen. Because of this previous affiliation, he places importance on the preservation of green space. He believes that the municipality of Copenhagen would be a healthier place to live and reach its carbon neutrality goal more easily if efforts were made to halt the destruction of green space.

3. Reduced Air and Noise Pollution

Reason:

Air and noise pollution will be reduced on the surface if the number of cars using

streets goes down. Both Mr. Jensen's first and second categories can help this category, and so he does not feel it is as important to consider in tunnel designs.

4. Cost

Reason:

Though cost is important, Mr. Jensen thought that Copenhagen needed to focus less on a project's cost. An expensive, but successful solution would have a greater effect in the future than a cheaper and less effective solution. He hoped that the city would see a project to reduce traffic as an investment in the future.

5. Accessibility

Reason:

Mr. Jensen ranked accessibility lowest of the categories he thought should be considered while designing a tunnel. He still felt that accessibility was worth considering, but he also understood the complexities of getting a tunnel design approved. Therefore, he ranked it below categories that relate to problems Copenhagen faces and below cost, which is a large part of the approval process.

6. Not Considered – Floodwater Management

Reason:

Anders Jensen believed that floodwater management should not be considered in the design of a traffic tunnel for Copenhagen. He believed that other, more effective solutions should be implemented and designers should focus efforts on the previous categories.

4.15.4. [Amager Visioning's Decision Matrix](#)

As a culmination of the research, interviews, and analysis of the seven tunnel scenarios conducted during an 8-week stay in Copenhagen, the project team, Amager Visioning (AV), also filled out a decision matrix. The purpose of the AV decision matrix is to express the group's knowledge of the traffic tunnel, floodwater management, and green space preservation situation in the city.

| Category | Cost | Accessibility | Floodwater Management | Reduced # of Surface Cars | Reduced Air and Noise Pollution | Preservation of Green Space | Total |
|---------------------------------|------|---------------|-----------------------|---------------------------|---------------------------------|-----------------------------|-------|
| Cost | - | 0 | 1 | 0 | 0 | 0 | 2 |
| Accessibility | 1 | - | 1 | 0 | 0 | 0 | 3 |
| Floodwater Management | 0 | 0 | - | 0 | 0 | 0 | 1 |
| Reduced # of Surface Cars | 1 | 1 | 1 | - | 1 | 1 | 6 |
| Reduced Air and Noise Pollution | 1 | 1 | 1 | 0 | - | 1 | 5 |
| Preservation of Green Space | 1 | 1 | 1 | 0 | 0 | - | 4 |

Table 36 - Amager Visioning's Pairwise Comparison Chart

The pairwise comparison chart above (Table 36) puts the team's tunnel evaluation criteria through a series of head-to-head matchups that determine the weighted point percentages in the decision matrix. AV ranked the categories as follows:

1. Reduced Number of Surface Cars

Reason:

The number of cars reduced from surface roads is the driving motivation behind this project. Traffic in Copenhagen is expected to grow by nearly 30,000 cars a day on the Langebro Bridge, one of the few bridges that connects Amager to the rest of the city. The infrastructure cannot handle this increase in cars and it contradicts the city's goals of being carbon neutral by 2025. It is the largest problem Copenhagen faces now, and if not addressed, will hinder the city's development and environmental goals.

2. Reduced Quantities of Air and Noise Pollution

Reason:

The reduced quantities of air and noise pollution within the city directly correlate to the number of cars reduced from surface roads. That is because when cars travel in a tunnel, the carbon dioxide emitted by cars is in a controlled environment and not released into the atmosphere. The same concept applies to noise pollution. In addition, Copenhagen needs to rapidly reduce the amount of carbon dioxide it releases daily if it has any hope of being carbon neutral. Building a traffic tunnel is a step in the right direction, and a design that better reduces the amount of carbon dioxide and noise released into the city is a better long-term investment for Copenhagen.

3. Amount of Preserved Green Space within the City

Reason:

Although not as high a priority as Copenhagen's traffic situation, green space is a limited resource. Once destroyed, it takes generations to recover and somewhat resemble its former self if possible. Plants act as the city's lungs by removing carbon dioxide from the air and using it to conduct photosynthesis. They also improve the livability of the city by providing people with a place to escape the daily hustle and bustle of the city. Since Amager Visioning worked in partnership with Miljøpunkt Amager, it is important to preserve what is left of Copenhagen's green space.

4. Accessibility of the Tunnel's Entrances/Exits

Reason:

A tunnel's accessibility determines how well it services the community. When people have easy access to a tunnel, the probability of them using it increases. Therefore, accessibility influences the number of cars reduced from surface roads and is of higher importance than cost and floodwater management.

5. Tunnel Cost

Reason:

After interviewing four experts and working closely with Anders Jensen, AV found that cost is a major contributor to the Eastern Ring Road stalemate. If a proposal is too costly, its chances of being passed and funded by the government drop. Hence, the team determined that it is more important than floodwater management capabilities.

6. Floodwater Management Capabilities

Reason:

Even though flooding is a major concern in Copenhagen with the recent severity of cloudbursts, with the help of Anders Jensen the team determined that each tunnel scenario has the holding capacity to keep floodwater off the streets. Because the floodwater management capabilities of each scenario are already sufficient, the point differential should be as small as possible. Thus, it is the least important category in the

AV's decision matrix.

| Categories | Weight | Point Total | Weighted Percentage |
|--|--------|-------------|---------------------|
| <i>Cost</i> | 2 | 21 | 9.5 |
| <i>Accessibility</i> | 3 | 21 | 14.3 |
| <i>Floodwater Management</i> | 1 | 21 | 4.8 |
| <i>Reduced # of Surface Cars</i> | 6 | 21 | 28.6 |
| <i>Reduced Air and Noise Pollution</i> | 5 | 21 | 23.8 |
| <i>Preservation of Green Space</i> | 4 | 21 | 19.0 |

Table 37 – Amager Visioning's Weight Allocation Table

Table 37 details the point allocation of each category based on the series of head-to-head matchups in the pairwise comparison chart. The column, outlined by the red box, is the point total each category earned on a 100-point scale.

| Categories | Calculated Weights | Scenario 0 | Scenario 1 | Scenario 2 | Scenario 3 | Scenario 4 | Scenario 5 | Scenario 6 |
|--|--------------------|-------------|-------------|-------------|-------------|-------------|-------------|-------------|
| <i>Cost</i> | 9.5 | 9.5 | 5.4 | 4.1 | 8.2 | 6.8 | 2.7 | 1.4 |
| <i>Accessibility</i> | 14.3 | 3.1 | 12.2 | 10.7 | 9.2 | 9.2 | 13.3 | 13.3 |
| <i>Floodwater Management</i> | 4.8 | 0.7 | 2.7 | 3.4 | 1.4 | 2.0 | 4.1 | 4.8 |
| <i>Reduced # of Surface Cars</i> | 28.6 | 4.1 | 15.0 | 15.0 | 17.7 | 17.7 | 28.6 | 28.6 |
| <i>Reduced Air and Noise Pollution</i> | 23.8 | 3.4 | 12.5 | 12.5 | 14.7 | 14.7 | 23.8 | 23.8 |
| <i>Preservation of Green Space</i> | 19.0 | 19.0 | 6.8 | 10.9 | 15.0 | 16.3 | 4.1 | 9.5 |
| Total | 100.0 | 39.8 | 54.6 | 56.5 | 66.1 | 66.8 | 76.5 | 81.3 |

Table 38 - Amager Visioning's Decision Matrix

4.15.5. Summary of the Decision Matrix Results

| <u>Name</u> | <u>Top Ranked Scenario</u> | <u>Second Ranked Scenario</u> |
|-------------------------|----------------------------|-------------------------------|
| <i>Nis Fink</i> | Scenario 6 (70.4 points) | Scenario 5 (69.7 points) |
| <i>Claus Knudsen</i> | Scenario 6 (77.6 points) | Scenario 5 (73.5 points) |
| <i>Anders Jensen</i> | Scenario 6 (74.8 points) | Scenarios 3, 4 (69.7 points) |
| <i>Amager Visioning</i> | Scenario 6 (81.3 points) | Scenario 5 (76.5 points) |

4.15.6. Conclusion to the Scenario Evaluations

Looking at the summary of the decision matrix results, Scenario 6 (Y-Connection with modified south entrance/exit) earned the most points in all four decision matrices. Scenario 6 ranked first in accessibility, floodwater management, number of surface cars reduced, and reduced quantities of air and noise pollution. Specifically, the number of surface cars reduced and quantities of air and noise pollution were allocated the highest point percentages points on average.

This shows that a majority of the participants feel traffic congestion is the largest problem Copenhagen is facing and is of the utmost importance. Therefore, Scenario 6 best handles this problem by providing six access points that funnel more cars underground than the other scenarios (thus reducing the effects of air and noise pollution).

In addition, the differentiating factor between Scenario 5 and Scenario 6 is the amount of green space preserved. Scenario 5 has the original E-R southern segment that cuts through Amager Faelled, destroying valuable green space. Scenario 6 does not destroy this green space. However, Scenario 5 earns some of these points back because it is cheaper (and shorter) than Scenario 6. This is the primary reason why Scenario 5 and 6 have nearly indistinguishable point values in Mr. Fink's decision matrix.

While Scenario 5 was a close second to Scenario 6 for three of the four participants, Scenarios 3 and 4 earned a joint second place in Anders Jensen's decision matrix. This is because he ranked floodwater management as not worth consideration. The points Scenario 5 lost here, Scenarios 3 and 4 gain due to more preserved green space and cheaper construction costs. However, all three scenarios (3, 4, and 5) are within one point of each other. This means that any variation in data or change in the point allocation format has the potential to alter the outcome of second place.

4.15.7. Creating a Variation in Results

There are many ways the compiled data could be analyzed. The decision matrix Amager Visioning created does so by ranking the scenarios in the evaluation criteria sub-categories (e.g. number of entrances/exits, number of cars expected to pass through daily, etc.). However, there are other possible methods of evaluating these subcategories. One is by finding the range of values in a sub-category and finding the percentage of points each scenario deserves based on that. For example, the estimated cost ranges from 0 to 37 billion DKK. This is the range. Every category's cost would then be divided by the range to get how much cheaper it is from the most expensive scenario.

$$(\text{Percentage of points earned}) = 100 \times \left(1 - \frac{\text{Cost of Scenario 5}}{\text{Range of Costs}}\right)$$

$$(\text{Percentage of points earned}) = 100 \times \left(1 - \left(\frac{34,800,450,000}{37,000,450,000}\right)\right)$$

$$(\text{Percentage of points earned}) = 5.9\%$$

This method attempts to provide more accurate results based on value differentials in each sub-category. While this method is also worth exploring, the results would be more in favor of Scenarios 5 and 6 (for every participant except Mr. Fink) since they reduce far more cars from surface roads than the other Scenarios. Mr. Fink is the only participant who would have a different pair of first and second place scenarios because he ranked cost as the highest category of importance. This means that with Scenarios 5 and 6 being more expensive than Scenarios 3 and 4, it is possible they would overtake the two Y-Connection scenarios in point totals.

4.16. **Conclusion**

The results outline the decision that the team made throughout the methodology. The final result of the comparisons of the tunnels were the decision matrices provided. The results provide possibilities for Copenhagen. Though the team's best result was Scenario 6 that does not mean that the Y-Connection (Scenario 6) is the best result from the public's perspective or from the municipality's perspective. Future work related to this project may use different categories or a different evaluation of these categories.

5.0 CONCLUSION & RECOMMENDATIONS

5.1. A Plan for the Future: Scenario 6 plus City Center Congestion Ring



Figure 68 – A Plan for the Future: Tunnel Scenario 6 with a Congestion Ring

After conducting interviews, research, and evaluating seven plausible tunnel scenarios, Amager Visioning favors the tunnel route detailed in Scenario 6, implemented in conjunction with a congestion charge zone like the one shown in Figure 66 of Section 4.13.4. With traffic projected to increase by nearly 30,000 cars across the Langebro Bridge and 12,500 across the Knippelsbro Bridge by the year 2032, there is a clear need for a tunnel (Miljøpunkt Nørrebro Preliminary Traffic Research, 2012). The Y-Connection above provides commuters with an alternative to

being stuck in traffic while attempting to cross Copenhagen Center. Commuters traveling through Nørrebro can use the Ladegårdsåen section of the tunnel (left fork shown in Figure 68) to avoid the bridges entirely. Similarly, northbound commuters traveling from south of the E20 or traveling from Amager can use the E-R (right fork shown in Figure 68) to avoid the city center. This reduces traffic congestion on surface roads, diminishes air pollution due to idling cars stuck in traffic, and funnels noise pollution into a tunnel.

[5.1.1. Nudging Drivers in the Right Direction using a Congestion Ring](#)

In addition to providing commuters with the option to use the tunnel, implementing a congestion ring around the city center discourages commuters from driving through it. A congestion ring has the potential to reduce traffic by fifty percent on all toll roads (Tetraplan A.S, 2013). This means that while a tunnel provides drivers the opportunity to stay off surface roads and avoid the city center, implementing tolls around it further encourages drivers to use the tunnel.

[5.1.2. Using Toll Money to Pay Back Construction Costs](#)

Another topic for consideration is using the money collected by tolls to pay for construction costs, and later, maintenance costs. If a 20 DKK per car toll is implemented and 60,200 cars travel over Langebro Bridge daily, then the municipality will make approximately 1.2 million DKK daily off the Langebro bridge toll alone (Tetraplan A.S, 2013). Over a 5-year span, that adds up to approximately 2.2 billion DKK⁶ on the Langebro Bridge alone and excludes the 80 DKK fee for trucks. Combined with tolls going to Christianshavn and the roads separating the five lakes, money collected by tolls will substantially reduce the financial burden (of the tunnel) on the municipality and taxpayers. In addition, money collected from tolls can be put towards maintenance and the generation of new green space in the city center after the tunnel construction costs are paid off.

5.2. Recommendations

One of the consistent problems Amager Visioning faced when surveying Amager's residents was the lack of public awareness. Of the thirty-six people surveyed, only 50% knew about the E-R and 56% of those people did not know enough about the proposal to have an opinion. Thirty-nine percent of the people who knew about it were in favor of the proposal. However, "when you talk

⁶(20 DKK) x (60,200 cars/day) x (365 days/year) x (5 years) = 2.197 billion DKK

about the tunnel at the abstract level, almost every person in Copenhagen thinks it's a good idea. But when you begin to make lines on the map and say here's the beginning of the tunnel, here's the end, and then the skepticism arises" (Lars Weiss). This means that instead of raising public awareness on the concept of a traffic tunnel through Copenhagen, it is more critical to raise public awareness on the tunnel route and reasoning behind it.

5.2.1. Using a Brochure to Raise Public Awareness

One method of raising public awareness is using brochures because they attract people's attentions and provide information to a large target audience (Ladd, 2010). They are also stackable, easy to transport and mass-produce, and can be distributed at numerous locations throughout the city. Information about the original E-R proposal, the original Ladegårdsåen proposal, the team's Y-Connection (Scenario 6), and the congestion ring should be included to increase public awareness about these proposals and encourage discussion about them as well. The brochure should also detail the strengths, weaknesses, and reasoning behind each design.

5.2.2. A Vision for Copenhagen

To envision a traffic solution for Copenhagen requires the participation of the public. There are solutions that solve some of Copenhagen's traffic problems, but a single solution that solves all of the problems does not yet exist. Amager Visioning provided a comparison of designs and an analysis of the designs in an attempt to provide Copenhagen with that single solution. A solution for Copenhagen would require more than just a solution to traffic. Consideration of green space, pollution, flooding, and traffic must be taken in any future efforts to create a vision.

WORKS CITED

- A/S, T. (2013). Transportministeriet-Supplerende trafikanalyser for Østlig Ringvej *Trafikmodelberegninger*.
<http://www.trm.dk/~media/Files/Publication/2013/Strategiske%20analyser/%C3%98stlig%20oringvej/Trafikmodelberegninger.pdf>: Transportministeriet.
- Administration, T. a. E. (2013). Copenhagen's Green Accounts, *Theme on traffic and noise*.
<http://subsite.kk.dk/sitecore/content/subsites/cityofcopenhagen/subsitefrontpage/livingincopenhagen/climateandenvironment/copenhagensgreenaccounts.aspx>
- Air Pollution: Smog, Smoke and Pollen. (n.d.).
<http://www.nrdc.org/health/climate/airpollution.asp>: Natural Resources Defense Council.
- Ambady, S., Hancock, K., Kohlman, K., & Siegle, M. (2014). *Providing Support For The Ladegårdsåen Daylighting Project*. Worcester Polytechnic Institute.
- Anglin, N.-M., Hassan, A., & Ruddy, S. (2012). Flood Prevention and Daylighting of the Ladegårdsåen *A Project to Create Green Space and to Provide Better Drainage of Rainwater*: Worcester Polytechnic Institute.
- Architecture, S. x. W. (n.d.). Nordhavnen-Sustainable City. Concept Urban Masterplan.
<http://www.sxwa.com.au/NORDHAVNEN>: Searle x Waldron Architecture.
- Association, A. (2014). London Congestion Charge. *When the scheme operates, who it affects and how you pay it*. 2014, from
https://www.theaa.com/motoring_advice/congestion_charging/
- Attwell, K. (2000). Urban land resources and urban planting — case studies from Denmark. *Landscape and Urban Planning*, 52(2–3), 145-163. doi: [http://dx.doi.org/10.1016/S0169-2046\(00\)00129-8](http://dx.doi.org/10.1016/S0169-2046(00)00129-8)
- BBC. (2003). Congestion Charging: In London. *What It Is*. 2014, from
http://news.bbc.co.uk/2/shared/spl/hi/uk/03/congestion_charge/exemptions_guide/html/what.stm
- Bronzaft, A. L. (2004). Noise Pollution. In R. M. Stapleton (Ed.), *Pollution A to Z* (Vol. 2, pp. 66-69). New York: Macmillan Reference USA.
- Buley, J. (2011). Drenched, *The Copenhagen Post*. Retrieved from
<http://cphpost.dk/news/drenched.1893.html>
- Buley, J. (2012). Congestion charge proposal ends in rubbish bin. *Solution to Copenhagen's traffic and air-pollution problems pushed off until next year*. Retrieved from The Copenhagen Post website: <http://cphpost.dk/news/congestion-charge-proposal-ends-in-rubbish-bin.858.html>
- By&Havn. (2010). Copenhagen Growing – The Story of Orestad.
www.orestad.dk/~media/images/copenhagen-growing_web.pdf

Cahasan, P., & Clark, A. F. (n.d.). Copenhagen, Denmark *5 Fingers Plan*. http://depts.washington.edu/open2100/Resources/1_OpenSpaceSystems/Open_Space_Systems/copenhagen.pdf: University of Washington.

Christiansen, F. (2013). Drøm om å på Åboulevarden får nyt liv. *Politiken*. Retrieved from Politiken Plus website: <http://politiken.dk/kultur/ECE2067998/droem-om-aa-paa-aaboulevarden-faar-nyt-liv/>

Commentary: A brief history of urban planning. (2012, 2012/07/13/). Brief article, *Daily Journal of Commerce (Portland, OR)*. Retrieved from http://go.galegroup.com/ps/i.do?id=GALE%7CA296965540&v=2.1&u=mlln_c_worpoly&it=r&p=ITOF&sw=w&asid=679f059caaf198215ad51a0c3c9d17bc

Congress, L. o. (2013). Bird's-Eye View of the World's Columbian Exposition, Chicago, 1893. 2014, from <http://www.wdl.org/en/item/11369/>

Copenhagen, C. o. (2013). Facts on Copenhagen. <http://subsite.kk.dk/sitecore/content/Subsites/CityOfCopenhagen/SubsiteFrontpage/Press/FactsOnCopenhagen.aspx>: City of Copenhagen.

Copenhagen Harbour Tunnel. Retrieved February 26, 2014, from http://www.cowi.dk/menu/project/Brotunnelogvandbygning/Tunneler/Saenketunneler/Documents/0233-1706-033e-05a_low.pdf

Copenhagen Metro. (n.d.). 2014, from <http://www.trm.dk/da/temaer/k%C3%B8benhavnsmetro/k%C3%B8benhavnsmetro/>

Copenhagen, S. (2013). Fact sheet from Statistics Copenhagen. www.kk.dk/statistik: Copenhagen City.

CW. (2013a). City Council Taking New Look at Old Stream. Retrieved from The Copenhagen Post website: <http://cphpost.dk/news/city-council-taking-new-look-at-old-stream.6760.html>

CW. (2013b). Storm Blew in Massive Clean-Up Bill, *The Copenhagen Post*. Retrieved from <http://cphpost.dk/news/storm-blew-in-massive-clean-up-bill.7638.html>

Danish Green Transport Plan to get the Environment Back on Track. (2011). from http://ec.europa.eu/environment/ecoap/about-eco-innovation/policies-matters/denmark/388_en.htm

De Ridder, K., Adamec, V., Bañuelos, A., Bruse, M., Bürger, M., Damsgaard, O., Weber, C. (2004). An integrated methodology to assess the benefits of urban green space. *Science of The Total Environment*, 334–335(0), 489–497. doi: <http://dx.doi.org/10.1016/j.scitotenv.2004.04.054>

Decibel Levels of Common Sounds. 2014, from <http://home.earthlink.net/~dnitzer/4HaasEaton/Decibel.html>

Denmark Population: Historical Data Graphs per Year. (n.d.). 2014, from <http://www.indexmundi.com/g/g.aspx?v=21&c=da&l=en>

Det Grønne København. (n.d.).

http://greenfutures.washington.edu/pdf/105_R_Parkpolitik.pdf: Green Futures at University of Washington.

Dockery, D. W., & Stone, P. H. (2007). Cardiovascular Risks from Fine Particulate Air Pollution. <http://www.nejm.org/doi/full/10.1056/NEJMe068274> doi:10.1056/NEJMe068274

Elisabeth, B. (2013). Tackling climate Change: Copenhagen's Sustainable City Design. <http://www.theguardian.com/sustainable-business/tackling-climate-change-copenhagen-sustainable-city-design>

Facts And Statistics. from <http://denmark.dk/en/quick-facts/facts/>

Gerdes, J. (2013). Copenhagen's Ambitious Push To Be Carbon Neutral by 2025. *Yale Environment* 360.

Good, Better, Best: The City of Copenhagen's Bicycle Strategy 2011-2015. (2014): City of Copenhagen. http://kk.sites.itera.dk/apps/kk_pub2/pdf/823_Bg65v7UH2t.pdf

Greenhouse Gas Emissions from a Typical Passenger Vehicle. (2011) *Questions and Answers*. <http://www.epa.gov/otaq/climate/documents/420f11041.pdf>: EPA: Office of Transportation and Air Quality.

H C Andersens Boulevard. (2008): VIA Trafik. <https://subsite.kk.dk/eDoc/Teknik-%20og%20Miljoedvalget/18-06-2008%2015.00.00/Dagsorden/18-06-2008%2013.58.45/3816234.PDF>

Hall, P., & Mark, T.-J. (2011). *Urban and Regional Planning*. London: Routledge. ISBN: 9780203861424

Hallegatte, S., Ranger, N., Mestre, O., Dumas, P., Corfee-Morlot, J., Herweijer, C., & Muir Wood, R. (2010). *Climate Change Assessing Climate Change Impacts, Sea Level Rise and Storm Surge Risk in Port Cities: A Case Study on Copenhagen*: Springer Science and Business Media B.V.

Harbour Tunnel in Copenhagen. (n.d.). Retrieved February 26, 2014, from <http://www.sla.dk/planlaeg/tunnelgb.htm>

Jeppeson, J., Christensen, S., & Ladekarl, U. L. (2010). Modelling the Historical Water Cycle of the Copenhagen Area 1850-2003. *Journal of Hydrology*.

Jørgensen, K. B. (2008). *Vurdering af havnetunnel alternativer i København*. Technical University of Denmark, DTU, DK-2800 Kgs. Lyngby, Denmark.

KM. (2013). Storm Cleanup Begins, *The Copenhagen Post*. Retrieved from <http://cphpost.dk/news/storm-cleanup-begins.7517.html>

- Knowles, R. D. (2012). Transit Oriented Development in Copenhagen, Denmark: from the Finger Plan to Ørestad. *Journal of Transport Geography*, 22(0), 251-261. doi: <http://dx.doi.org/10.1016/j.jtrangeo.2012.01.009>
- Kommune, K. Københavnekortet. from City of Copenhagen <http://kbhkort.kk.dk/cbkort>
- Kristensen, J. P., & Nielsen, O. A. (2006). Measuring Congestion in Copenhagen with GPS. Retrieved from TRD: The TRIS and ITRD Database website: <http://trid.trb.org/view/2006/C/847055>
- Krzyzanowski, M. (2005). Health effects of transport-related air pollution. In W. H. Organization (Ed.). <http://www.euro.who.int/en/publications/abstracts/health-effects-of-transport-related-air-pollution-summary-for-policy-makers>.
- Kulturkanonen. 2014, from http://kum.dk/Documents/Temaer/Kulturkanon/KUM_kulturkanonen_OK2.pdf
- København Cityringen contractors selected. (2010, 25 November 2010). *Railway Gazette*. Retrieved from <http://www.railwaygazette.com/news/single-view/view/koebenhavn-cityringen-contractors-selected.html>
- Københavns Kommune. (n.d.). Københavns Kommune, from Københavns Kommune <http://www.kk.dk>
- Ladd, A. D. (2010). Developing Effective Marketing Materials: Brochure Design Considerations 2014, from <https://ag.tennessee.edu/cpa/Information%20Sheets/cpa179.pdf>
- Lindholm, L. (n.d.). Cycling in Copenhagen-The Easy Way. 2014, from <http://denmark.dk/en/green-living/bicycle-culture/cycling-in-copenhagen---the-easy-way/>
- London, c. (2010). London Congestion Charge. 2014, from <http://cchargelondon.com>
- Metro. (n.d.). 2014. <http://intl.m.dk/#/>
- Mufti, S. (2012). Half Fear Home Flooding, *The Copenhagen Post*. Retrieved from <http://cphpost.dk/news/half-fear-home-flooding.2106.html>
- Nielsen, J. S. (2011). In Cities Struggle Against the Flood: information.dk.
- Nielsen, T. S., & Hansen, K. B. (2007). Do green areas affect health? Results from a Danish survey on the use of green areas and health indicators. *Health & Place*, 13(4), 839-850. doi: <http://dx.doi.org/10.1016/j.healthplace.2007.02.001>
- Noise Pollution. (2008). In K. L. Lerner & B. W. Lerner (Eds.), *The Gale Encyclopedia of Science* (4th ed. ed., Vol. 4, pp. 3003-3005). Detroit: Gale.
- Olsson, L., & Loerakker, J. (2013). The Story Behind Failure: Copenhagen's Business District Ørestad. 2014, from <http://failedarchitecture.com/the-story-behind-the-failure-copenhagens-business-district-orestad/>

Project Background-The Big Dig. (n.d.). Retrieved 2014, from <https://www.massdot.state.ma.us/highway/TheBigDig/ProjectBackground.aspx#achievements>

Quality, O. o. T. a. A. (2011). Greenhouse Gas Emissions from a Typical Passenger Vehicle. <http://www.epa.gov/otaq/climate/documents/420f11041.pdf>

Reps, J. W. (n.d.). Report Of The Senate Committee On The District Of Columbia On The Improvement Of The Park System Of The District Of Columbia. from <http://urbanplanning.library.cornell.edu/DOCS/parkcomm.htm>

Road Traffic Noise and Diabetes. (2013) *Long-Term Exposure May Increase Disease Risk* (Vol. 121). http://ehp.niehs.nih.gov/pdf-files/2013/Feb/ehp.121-a60_508.pdf: Environmental Health Perspectives.

Roos, J. Jason Roos's Bucket. Retrieved February 13, 2014, from http://s174.photobucket.com/user/KenMasters_photo/media/4332523-til-bt-skybrud.jpg.html

Ruby, L. (n.d.). How Denmark Became A Cycling Nation. from <http://denmark.dk/en/green-living/bicycle-culture/how-denmark-become-a-cycling-nation/>

Sciences, N. I. o. E. H. (2013). Air Pollution. <http://www.niehs.nih.gov/health/topics/exposure/air-pollution/>

Stanners, P. (2013). High Winds and Storm Surge Leave Wake of Destruction, *The Copenhagen Post*. Retrieved from <http://cphpost.dk/news/high-winds-and-storm-surge-leave-wake-of-destruction.8047.html>

Sustainable Transport- Better Infrastructure. (2008). from <http://www.trm.dk/graphics/Synkron-Library/trafikministeriet/Publikationer/2008/B%E6redygtig%20transport/Sustainable%20transport%20TRM.pdf>

Transportministeriet. (2013). Østlig Ringvej: Strategisk analyse af en havnetunnel i København. <http://www.trm.dk/~media/Files/Publication/2013/Strategiske%20analyser/%C3%98stlig%20oringvej/Strategisk%20analyse%20af%20en%20havnetunnel%20i%20K%C3%B8benhavn.pdf>: Transportministeriet.

Tunnel under Åboulevarden. (2013): Rambøll.

Tørsløv, N. (2010, May 2010). Traffic In Copenhagen 2009. 2014, from <https://subsite.kk.dk/sitecore/content/Subsites/CityOfCopenhagen/SubsiteFrontpage/~media/BF3A66B079AB4ACAA6CA167ECF151EB3.ashx>

Udviklingselskabet, B., Havn, & Ørestad. (2011). *Copenhagen Growing: The Story of Ørestad*: CPH City & Port Development.

Underground Caverns could Solve Flooding Woes. (2012). Retrieved February 12, 2014, from <http://www.eco-business.com/news/underground-caverns-could-solve-flooding-woes/>

Van Zutphen, G. (2011). Jurong Rock Caverns: Singapore's S\$950 Million Dollar Hole in the Ground, *CNN Travel*. Retrieved from <http://travel.cnn.com/singapore/life/jurong-rock-caverns-billion-dollar-hole-ground-381834>

Vestergaard, J. S. (2011). Improved Nowcasting of Heavy Weather Radar Data. Retrieved February 26, 2014, from http://www2.imm.dtu.dk/~jsve/posters/poster_groentprojekt.pdf

Vision and Mission. (n.d.). 2014, from <http://www.byoghavn.dk/ombyoghavn/vision+og+mission.aspx>

VisitCopenhagen. (2014). Life on Refshaleøen. <http://www.visitcopenhagen.com/copenhagen/sport/life-refshaleoen: Wonderful Copenhagen>.

Vuk, G. (2005). Transport impacts of the Copenhagen Metro. *Journal of Transport Geography*, 13(3), 223-233. doi: <http://dx.doi.org/10.1016/j.jtrangeo.2004.10.005>

Walsh, M. P. (2011). Car Lines. *Car Lines*. 2011 4. 2014, from <http://walshcarlines.com/pdf/nsl20114.pdf>

What is Urbanization? (2010). Retrieved April 3, 2014, from http://www.epa.gov/caddis/ssr_urb_urb1.html

Wimmelmann, P. (2009). Copenhagen-City-Tunnel. Retrieved from www.kobenhavertunnelen.dk website: <http://www.kobenhavertunnelen.dk/.../Copenhagen-tunnel-city-group%2027...%E2%80%8E%20Cached%20Similar%20Share>

Ørestad: Failure or Work in Progress? (2013). Retrieved from disPATCH website: <http://dispatch.dis.dk/story/%C3%B8restad-failure-or-work-progress>

Østlig Ringvej København. (2013) *Vurdering Af 4 Alternative Projektudformninger*. <http://www.trm.dk/~media/Files/Publication/2013/Strategiske%20analyser/%C3%98stlig%20Oringvej/Vurdering%20af%204%20alternative%20projektudformninger.pdf>: Vejdirektoratet.

APPENDICES

Appendix A – Interviews

Below are the interviews that outlines of the interviews performed either through personal contact or through e-mail. Explanations of the questions are provided under each question.

[Interview Outline-Anders Rody Hansen \(Traffic Expert, Municipal Employee\)](#)

You are not required to answer any questions that may be asked and you can stop the survey at any point. Do you give consent to record this interview?

If yes, your answers will be recorded and may be used in the future.

We are working with Miljøpunkt Amager to create several tunnel options to facilitate faster travel times across Copenhagen when driving a car, while also reducing surface road congestion. These tunnel scenarios will include alternate routes and connections to current tunnel proposals, possible connections to public transit, and possible floodwater alleviation methods.

Our topic today is current and projected traffic conditions in Copenhagen.

1. How does traffic currently flow through Copenhagen?

This question is important because it will solidify our understanding of traffic based on numbers and figures that we have obtained through our research

As a team we want to know where the most common travel takes place through the city (i.e. to the airport, to central Copenhagen, to Amager)

2. Where is congestion the worst in the city?

This will give us an idea of where the worst traffic is and how important it will be to develop a tunnel that will reduce vehicular traffic

3. What is Copenhagen's primary focus in order to alleviate traffic?

We will receive insight into the most important strategy that Copenhagen has in place to reduce traffic

This will prioritize whether our tunnel we be more or less viable, depending on if tunnel construction is a primary focus. If other manners are considered, we will have to consider how this will affect our proposal

4. What has Copenhagen done so far to reduce the amount of traffic in the city?

Similar to the last question this will inform us how the city has dealt with traffic up until this point. We understand, that there have been several new constructions that reduce the amount of traffic, but were these their main purposes or just secondary solutions?

5. Are you familiar with Eastern Ring Road plan?

We want to make sure that he knows about it before going on to question them further.

6. Is the Eastern Ring Road a viable option for alleviating traffic in Copenhagen?

According to the Municipality who has suggested the Eastern Ring Road, it is a viable option, but from an impartial view, we would like to know whether this will actually help traffic in Copenhagen

7. Is there a consideration of how traffic will affect Amager if the Eastern Ring Road is built?

Following up to the previous question we want to know whether Amager has been considered or just Central Copenhagen, and if Amager hasn't been considered so much, why.

8. Do you believe that the Eastern Ring Road is the best option for Copenhagen? If no, what else do you believe could be done to reduce traffic?

Leading up from whether it is actually viable, this questions seeks to understand whether this is considered the overall best option and whether it will only solve traffic or whether it will solve more.

[Interview Outline - Nis Fink \(HOFOR Representative – Water Management\)](#)

You are not required to answer any questions that may be asked and you can stop the survey at any point. Do you give consent to record this interview?

If yes, your answers will be recorded and may be used in the future.

We are working with Miljøpunkt Amager to create several tunnel options to facilitate faster travel times across Copenhagen when driving a car, while also reducing surface road congestion. These tunnel scenarios will include alternate routes and connections to current tunnel proposals, possible connections to public transit, and possible floodwater alleviation methods.

Our topic today is current storm water handling infrastructure in Copenhagen.

1. What does HOFOR do with the water that it collects?

We seek to get a better understanding of the overall process of how water collection works.

2. How did the large rainfall affect HOFOR in the recent years?

We want to know the effects that flooding and an overall increase in rainfall has had on major water collection facilities

3. Are you aware of the Ladegårdsåen project? If not, we will explain. If yes, how does HOFOR feel about its management concepts? How do you feel about its management concepts?

We want to judge the design of the last project as we will be using their reservoir tunnel design. If it is not viable we may consider suggestions that will improve the tunnel, but if viable it will further strengthen the importance of our tunnel

4. Is there a desire to create a better drainage system in Amager?

This question will pose the importance of a drainage system and depending on the previous question, whether the reservoir tunnel will be the proper drainage system that could be used.

5. Does HOFOR feel that green space and an increase in permeable surface area are good ways to reduce the amount of flooding? Does this take business away from HOFOR?

This question will allow us to understand the companies stand on green space as a viable option for reducing flooding. We will also understand if this is reducing the need for their company or

assisting them.

6. Would a solution similar to the Ladegårdsåen project be beneficial to HOFOR?

This question will gauge the interest HOFOR has in creating a tunnel that will manage large amounts of storm water.

7. Proceed with unscripted questions

Interview Outline - Lars Weis (Local Politician and Resident of Amager)

You are not required to answer any questions that may be asked and you can stop the survey at any point. Do you give consent to record this interview?

If yes, your answers will be recorded and may be used in the future.

We are working with Miljøpunkt Amager to create several tunnel options to facilitate faster travel times across Copenhagen when driving a car, while also reducing surface road congestion. These tunnel scenarios will include alternate routes and connections to current tunnel proposals, possible connections to public transit, and possible floodwater alleviation methods.

Our topic today is public opinion on traffic conditions and the possibility of tunnel construction in Copenhagen.

1. What is your current position?

So that we can get a clear understanding of his exact position in politics and whether his association with his political party will affect his answers even though he is also a resident of Amager

2. Do you believe that there is a traffic problem currently on Amager?

If so, do you feel the people are unhappy about the traffic situation?

This question allows a political standpoint on the matter of current traffic levels in Amager and how the people feel about the matter (are there many complaints about it)

3. Are you aware of the Ladegårdsåen and the Eastern Ring Road projects?

This question is used to judge the politician's understanding of the subject, which should be sufficient due to the fact that the Eastern Ring Road is at least being developed by the municipality

4. Do you think there is a need for either of these tunnels? Do you think there is a better solution that could be implemented?

This question will allow us to judge the opinion of the public based on their representative politician. This will also provide an understanding of whether there is need for a solution that finds a median ground.

5. What are some of the most important things that the people would want to see in a tunnel proposal?

This provides us a chance to get a better understanding of what will make our tunnel more appealing to the people and the government.

6. Proceed with unscripted questions

Interview Outline – Resident near the Metro Construction

You are not required to answer any questions that may be asked and you can stop the survey at any point. Do you give consent to record this interview?

If yes, your answers will be recorded and may be used in the future.

We are working with Miljøpunkt Amager to create several tunnel options to facilitate faster travel times across Copenhagen when driving a car, while also reducing surface road congestion. These tunnel scenarios will include alternate routes and connections to current tunnel proposals, possible connections to public transit, and possible floodwater alleviation methods.

Our topic today is construction in Copenhagen and its effects on the city's residents.

1. How long have you lived in this area?

This question allows us to understand their history of living in the area (i.e. have they been here for the whole construction, part of it, just moved)

2. When did the metro construction start?

This question depends on the above question. Despite the fact that there is an official date that the metro began, we would like to know when actual construction began.

3. Has the construction interfered with your day to day life?

This question will allow us to determine whether the metro construction is being intrusive. This is important because we assume that if our tunnel is created there will be similar construction to the metro

4. How long has the construction bothered you?

This question allows us to understand if it has always been a bother or whether it was less bothersome and has somehow changed.

5. Have you/will you receive settlement fees for suffering with the noise pollution?

This question is straightforward and will allow us to figure out how much money was given to residents near the metro.

6. Would additional construction like this throughout the city bother you?

This question provides us with an understanding as to how much the construction actually

bothers local residents, or whether it is something that can be adapted to.

7. Proceed with unscripted questions

Appendix B – Public Opinion Survey

Below is the public opinion survey distributed to people near Amager Centret. Explanations of the questions are provided under each question.

Public Opinion Survey

All questions are optional and do not have to be answered.

The purpose of this survey is to gage your opinion on some construction projects that may take place in the future. Please check the boxes that apply and answer to the best of your ability.

General Information

1. How old are you?

- 18-24 25-34 35-44 45-54 55-64 65 +

2. What is your gender?

- Male Female

3. Where do you live?

- Østerbro Nørrebro Indre By Vesterbro Christianshavn
 Amager Øst Amager Vest Other _____

4. How do you commute daily? (Check all that apply) Car Bicycle

- S-Tog Metro Walking Other _____

Current activity in Copenhagen

5. How do you feel about the construction in Copenhagen currently? (check all that apply)

- It is too loud It is disruptive It is for a good cause, so I am okay with it
 I do not care It is for a good cause, but I am not okay with it

6. How would you feel about additional construction to build a tunnel under the city for cars to use?

- I would be in favor I would not be in favor I do not care

7. What is your opinion on the traffic situation in Copenhagen?
 (1=No problems 2=There are some cars, but its ok 3=It is congested at times
 4=It is often really bad 5=It is horrible)

Public Awareness

8. Currently, the municipality is planning some major traffic projects within the city. Please check the boxes of the proposed future traffic projects that you are aware of.

Eastern Ring Road Ladegårdsåen Project Other _____

9. Of the projects you are aware of, how much are you in favor of them?
 1 = I am not in favor; 2 = Neutral 3 = I am in favor

Eastern Ring Road Ladegårdsåen Project
 Other _____

Amager Fælled

10. Of the statements below, which explains how you feel about Amager Fælled?
 I like Amager Fælled the way it is I wish Amager Fælled was a more organized park
 I do not like Amager Fælled I do not care about Amager Fælled
 No opinion, I do not use Amager Fælled
11. How would you feel about Amager Fælled being used in future traffic projects that may replace some of the green space?
 I would be angry I would not care I would like it
12. Would you be interested in an alternative that avoids using Amager Fælled for future traffic projects?
 Yes No I do not care

Metro Connection

13. Would having underground parking for cars that connects to the Metro increase your interest in building a tunnel?
 Yes No I do not care
14. Would you be more likely to use the Metro to travel to Central Copenhagen if underground parking was provided? Yes No I do not care

Analysis of Survey Questions

General Information

1. How old are you?

- 18-24 25-34 35-44 45-54 55-64 65 +

This a demographics question and is relevant because it determines which age bracket the participant falls into. This question will also help us determine if any trends fit a specific age group, such as young people are more likely to bike, or elderly people are more knowledgeable about current projects.

2. What is your gender?

- Male Female

This is also a demographics question and will allow us to determine if there are any trends based on the gender of participants.

3. Where do you live?

- Østerbro Nørrebro Indre By Vesterbro Christianshavn
 Amager Øst Amager Vest Other _____

This question lets us know what district the participant is from, which will allow us to better understand if there is any inclinations that may cause a certain district to answer in a certain manner.

4. How do you travel to work? (Check all that apply) Car Bicycle

- S-Tog Metro Walking Other _____

The manner of transportation to work is the most common way of transportation for many people. By determining preferred means of transportation, the following questions concerning metro construction and tunnel construction may differ in response.

Current activity in Copenhagen

5. How do you feel about the construction in Copenhagen currently? (check all that apply)

- It is too loud It is disruptive It is for a good cause, so I am okay with it
 I do not care It is for a good cause, but I am not okay with it

The concerns of the people is one of the driving factors of the project. If people do not want more construction than it is important to know that. However if people are ok with the construction than it will ok to proceed with more construction.

6. How would you feel about additional construction to build a tunnel under the city for cars to use?

- I would be in favor I would not be in favor I do not care

This question is relevant to people that care about the construction in the city and people who will most likely be affected in their daily commute. Like the previous question, if there is a strong desire for a tunnel than a tunnel is more likely the proper answer, however if there is extreme dislike of the tunnel and no one will use it than there is less desire for the tunnel.

7. What is your opinion on the traffic situation in Copenhagen?

*(1=No problems 2=There are some cars, but its ok 3=It is congested at times
4=It is often really bad 5=It is horrible)*

-

This question will determine if the participant believes there is a traffic problem in Copenhagen. If the participant feels that Copenhagen does not have too much motor traffic congestion, then he or she will be less likely to be in favor of constructing any of the proposed motor vehicle transit projects. If the participant feels that Copenhagen has too much motor vehicle traffic congestion, then they are more likely to be in favor of constructing any of the proposed motor vehicle transit projects.

Public Awareness

8. Currently, the municipality is planning some major traffic projects within the city. Please check the boxes of the proposed future traffic projects that you are aware of.

Eastern Ring Road Ladegårdsåen Project Other _____

The sole purpose for asking this question is to gage the participant's knowledge of current motor vehicle transit projects that have been proposed in the city.

9. Of the projects you are aware of, how much are you in favor of them?

1 = I am not in favor; 2 = Neutral 3 = I am in favor

Eastern Ring Road Ladegårdsåen Project

Other _____

This question will judge whether the participants are in favor of the projects or not and also whether there is another project that participants are more in favor of.

Amager Fælled

10. How do you feel about Amager Fælled?

I like Amager Fælled the way it is I wish Amager Fælled was a more organized park
 I do not like Amager Fælled I do not care about Amager Fælled
 No opinion, I do not use Amager Fælled

It is important to know how the citizens of Amager view Amager Fælled because it is the largest section of green space on the island and building roads through it reduces its value as an effective green space.

11. How would you feel about Amager Fælled being used in future traffic projects that may replace some of the green space?

I would be angry I would not care I would like it

Similar to the last question it is also judging the importance of the Fælled to the participants.

12. Would you be interested in an alternative that avoids surfacing in Amager Fælled?

Yes No I do not care

If the participant says yes, it means that they want to preserve Amager Faelled as a green space and alternatives to surfacing can be explored. Boring the tunnel and having an underground connection would not disturb surface wildlife. We could also explore alternative routes that will avoid crossing Amager Faelled.

Metro Connection

13. Would having underground parking that connects to the Metro increase your interest in building a tunnel? Yes No I do not care

If a majority of participants answers yes, then this is a selling point for a tunnel design that includes underground parking that connects to the Metro and S-Tog transit lines. Making this accommodation will also influence the path of possible tunnel routes. If a majority of participants answers no, then providing underground parking will not be much of a concern to us and will not influence the path of possible tunnel designs.

14. Would you be more likely to use the Metro to travel to Central Copenhagen if underground parking was provided? Yes No I do not care

This also influences the importance put on suggesting the addition of underground parking that connects to the metro.

Appendix C – Interview Summary Forms

Nis Fink Interview Summary Form

Contact Name: Nis Fink **Contact Occupation:** HOFOR - Planning – Rain and Waste Water

Visit: Met him at HOFOR **Contact Date:** March 26th 2014

Summary Author: TBB

Give a brief description of the importance of meeting with this contact and what was addressed in the interview.

Nis Fink works for HOFOR, which is the main water management company for Copenhagen. He works in the planning department of Rain and Waste Water so he is aware of the increasing need for better floodwater management. The main topics of the interview were current sewer systems, flooding, HOFOR plan of action, and the Ladegårdsåen project.

Summarize the relevant information you got on each of the target topics that were asked of the contact.

| Topic | Response |
|-----------------------|--|
| Current sewer systems | <p>A majority of Copenhagen is serviced by a combined sewer system in which waste water and rain water are flowing together in the same pipe</p> <p>The mixed water from the pipes goes to one of the two treatment plants in Copenhagen</p> <p>When there is too much rain the sewers are allowed to overflow every one in 10 years</p> <p>With the increasing size of storms the 10 year storm will be more common and another solution will be required that is not flooding the sewers</p> |
| Flooding | <p>According to Nis Fink there are several major areas of flooding</p> <p>On Amager there is a broad area that gets flooded and no specific zone itself</p> <p>There is a zone along where all the train lines converge that often floods</p> <p>There are more areas on the outskirts of Copenhagen that also flood</p> |
| HOFOR plan of action | <p>There are two options that can be taken to increase the preparedness of the city</p> <p>The sewers can be expanded through lots of construction and tearing up of roads</p> <p>Or, surface level solutions can be implemented, including</p> |

| | |
|----------------------|--|
| | <p>creating rain gardens and permeable surfaces</p> <p>HOFOR can implement small solutions in several areas of the city that will reduce flooding without creating large construction</p> |
| Ladegårdsåen Project | <p>The project would be able to collect a lot of water that does suffer from flooding but it is mainly meant to solve the traffic problem</p> <p>The 6-8 billion DKK plan would not help reduce flooding as much as the plans that HOFOR could implement</p> |

Lars Weiss Interview Summary Form

Contact Name: Lars Weiss **Contact Description:** Member of City Council
Visit: Met at City Hall **Contact Date:** April 8th 2014
Summary Author: TBB

Give a brief description of the importance of meeting with this contact and what was addressed in the interview.

Lars Weiss is a member of the City Council. He is also a resident of Amager Vest (the location of Amager Fælled). He is aware of the political landscape surrounding the Eastern Ring Road and other traffic based political discussions. The main topics addressed during the interview were the Eastern Ring Road, traffic, the Ladegårdsåsen Project, and the public opinion.

Summarize the relevant information you got on each of the target topics that were asked of the contact.

| Topic | | Response |
|-------------------|-------------------|--|
| Eastern Ring Road | | <p>Most of city hall is in favor of the Eastern Ring Road, except it is too expensive</p> <p>Part of the reason that it is called a ring road is so that the state will also provide funding for the tunnel.</p> <p>A decision will not be made for a long time (20-25 years)</p> |
| Traffic | Current problem | <p>There is a traffic problem in Amager</p> <p>A major motorway from Southern Zealand ends in Southern Amager</p> <p>Roads from the highways are not capable of handling the large amount of cars</p> <p>The current ring road (the O2) goes right through the middle of the city (Kongens Nytorv) and causes traffic, which in the future will be even more traffic running through the middle of the city.</p> |
| | Current Solutions | <p>A new road from the northern highway is making a connection to Nordhavn in an attempt to reduce traffic</p> <p>Congestion charges were popular amongst the city council because they would reduce traffic and they would also create revenue but they were declined by the state</p> |
| | Future Solutions | <p>Over the next ten years, hopefully the Metro will be able to reduce traffic for the short term, but the metro alone can't reduce all the congestion</p> <p>Improve the bus system, possibly create a light rail system (tram)</p> <p>Construct a tunnel</p> |

| | |
|-----------------------------|--|
| <p>Ladegårdsåen Project</p> | <p>A current road will be placed underground so there wont be an increase in the capacity of roads, but it will create much needed recreational space for an area fo the city that doesn't have many parks</p> <p>Reality of it is that some of the land that is opened up will have to be used for housing development</p> <p>The idea of a long green lawn running into the city is more of a drema than a reality</p> <p>A deceision on the tunnel will take quite a bit of time and it would still only be a 50-50 chance of actually going through currently.</p> <p>A combination of the Ladegårdsåen and the E-R would likely help reduce traffic, but the costs of making such a tunnel may prevent it from happening</p> <p>Currently the main focus is on the expansion of the metro</p> |
| <p>Public Opinion</p> | <p>“Its very favorable...maybe not very”</p> <p>“When you talk about the tunnel at the abstract level, almost every person in Copenhagen thinks it's a good idea. But when you begin to make lines on the map and say here's the beginning of the tunnel, here's the end, and then the skepticism arises”</p> <p>There are people that like the idea of the Eastern Ring Road, but the actual location of it is often an issue, specifically the surfacing in Amager Fælled.</p> <p>Looking at a possibility that would not surface in Amager Fælled</p> |

[Julie Schack Interview Summary Form](#)

Contact Name: Julie Schack **Contact Description:** Resident near Metro Construction
Form of Contact: Came to our office **Contact Date:** March 25th 2014
Summary Author: TBB

Give a brief description of the importance of meeting with this contact and what was addressed in the interview.

Julie Schack is a college student that lives near the metro construction in Østerbro. She has lived in Copenhagen her entire life and has been living near the construction since August 2013. She is a first-hand representative of how the construction in Copenhagen has affected the residents. The main topics addressed in the interview were intrusion of construction in her daily life, the compensation that she would receive, and the possibility of future construction projects.

Summarize the relevant information you got on each of the target topics that were asked of the contact.

| Topic | Response |
|------------------------------|--|
| Intrusion in Daily Life | <p>Construction would wake her up in the morning around 6:00 and then it would still be going when she went to bed at night</p> <p>She has felt vibrations from the construction in her apartment sometimes</p> <p>The construction has been bothersome even though she moved in after the construction had started</p> <p>The hours had changed (from ending at 18:00 to ending at 22:00) after she moved in and just recently had changed back</p> |
| Compensation | <p>She will receive a settlement for the annoyance that the construction has caused</p> <p>Eight residents will receive 10,000 DKK</p> <p>Originally two apartments were going to be given as a single apartment</p> <p>A her friend's apartment actually received 20,000 DKK</p> |
| Future Construction Projects | <p>Additional construction would bother her even if she did not live right next to it.</p> <p>Construction bothers most people because it is noisy and ugly (including the green barriers that are put up around the metro construction)</p> <p>She can appreciate what the construction is doing for the city even though she would not use the metro because she bikes</p> <p>Often the construction is a hassle for those that aren't benefitting from what is being built.</p> |

Susanne Rasmussen Discussion Summary Form

Contact Name: Susanne Rasmussen **Contact Desc.:** Secretary of Amager Vest Local Council
Visit: Met at Amager Vest Local Council Office **Contact Date:** March 27th 2014
Summary Author: TBB

Give a brief description of the importance of meeting with this contact and what was addressed in the interview.

Susanne Rasmussen works with the local council of Amager Vest, which is the location of Amager Fælled. She also works closely with the people of Amager Vest so she is capable of voicing the opinions of the citizens in the area. She is also aware of the political landscape surrounding the Eastern Ring Road. The main topics addressed in the interview were traffic, the Eastern Ring Road, Amager Fælled, and the consideration of Amager

Summarize the relevant information you got on each of the target topics that were asked of the contact.

| Topic | Response |
|-------------------------|--|
| Traffic | There is a traffic problem in Copenhagen The streets are too narrow in Copenhagen to address the growing traffic congestion |
| Eastern Ring Road (E-R) | There is a lot of mercury in the harbor so the Harbour tunnel was abandoned, due to the fact that it would cause more problems A study was done on the E-R by the government (who would pay for the E-R) and it showed that the Eastern Ring Road would not solve traffic congestion The E-R would tear up a large portion of Amager Fælled The portion that surface in the Fælled is not servicing that many people |
| Amager Fælled | People that live near the Fælled are concerned about the E-R construction Inhabitants worry about noise and construction affecting their daily life The Fælled is one of the last large natural plots of land near the city center Led a walk through Amager Fælled to show politicians and local the importance of the Fælled. It is sometimes difficult to use the Fælled because it is not easy to enter and is not as organized as it could be |
| Consideration of Amager | “Us vs. them” complex Often Amager doesn’t agree with the city areas because of the |

| | |
|--|--|
| | <p>difference in opinion</p> <p>Even though they are part of Copenhagen they often feel separate</p> <p>This complex is part of the issue in the E-R debates</p> |
|--|--|