

Physical Layer - Part 2

Data Encoding Techniques

Analog and Digital Transmissions

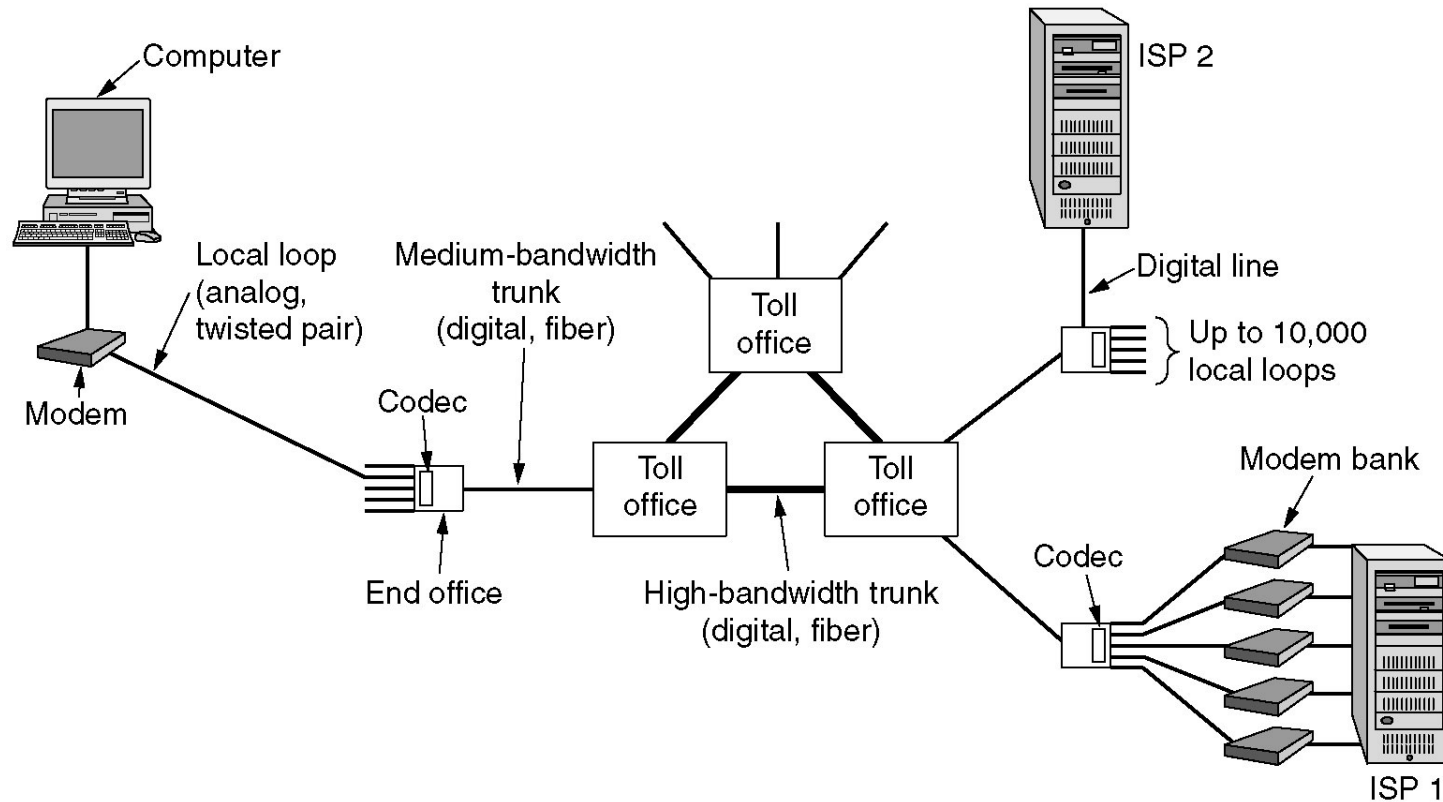

Figure 2-23. The use of both analog and digital transmissions for a computer to computer call. Conversion is done by the modems and codecs.

Data Encoding Techniques

- Digital Data, Analog Signals [**modem**]
- Digital Data, Digital Signals [**wired LAN**]
- Analog Data, Digital Signals [**codec**]
 - Frequency Division Multiplexing (FDM)
 - Wave Division Multiplexing (WDM) [**fiber**]
 - Time Division Multiplexing (TDM)
 - Pulse Code Modulation (PCM) [**T1**]
 - Delta Modulation

Digital Data, Analog Signals

[Example - modem]

- Basis for analog signaling is a continuous, constant-frequency signal known as the *carrier frequency*.
- Digital data is encoded by modulating one of the three characteristics of the carrier: amplitude, frequency, or phase or some combination of these.

A binary signal

(a)

Amplitude modulation

(b)

Frequency modulation

(c)

Phase modulation

(d)

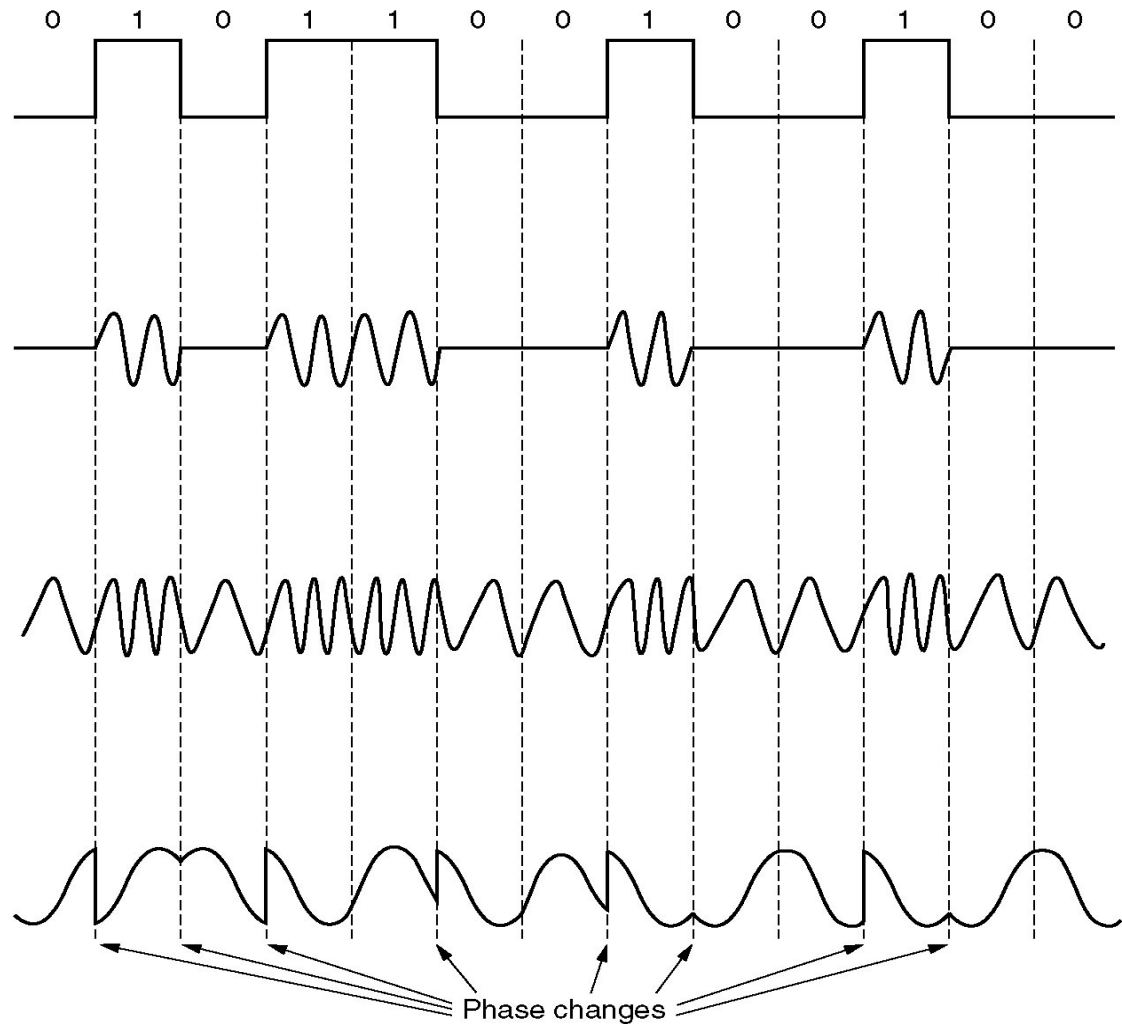
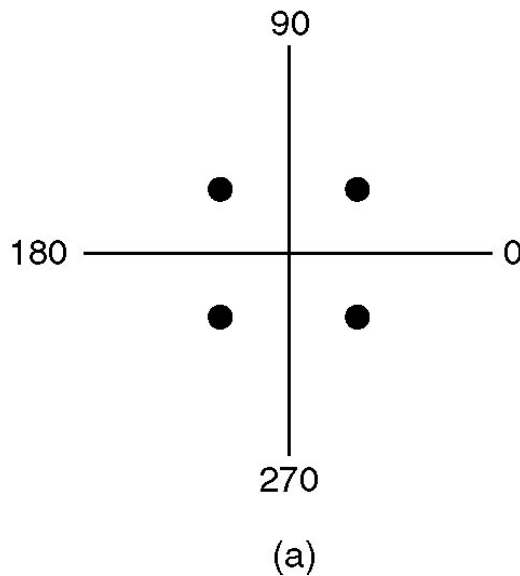

Figure 2-24.

Modems

- All advanced modems use a *combination of modulation techniques* to transmit multiple bits per baud.
- Multiple amplitude and multiple phase shifts are combined to transmit several bits per symbol.
- **QPSK (Quadrature Phase Shift Keying)** uses multiple phase shifts per symbol.
- **Modems** actually use **Quadrature Amplitude Modulation (QAM)**.
- These concepts are explained using constellation points where a point determines a specific amplitude and phase.

Constellation Diagrams



(a) QPSK.

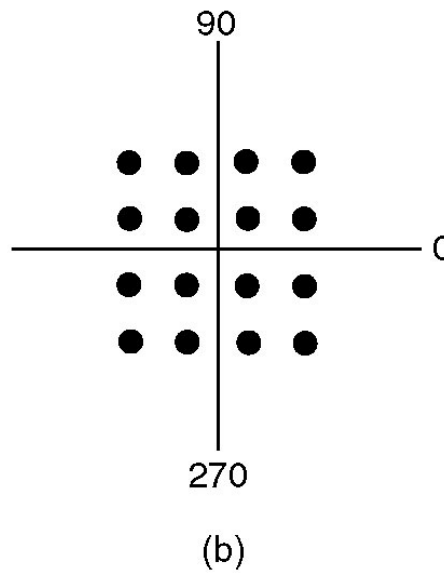

(b) QAM-16.

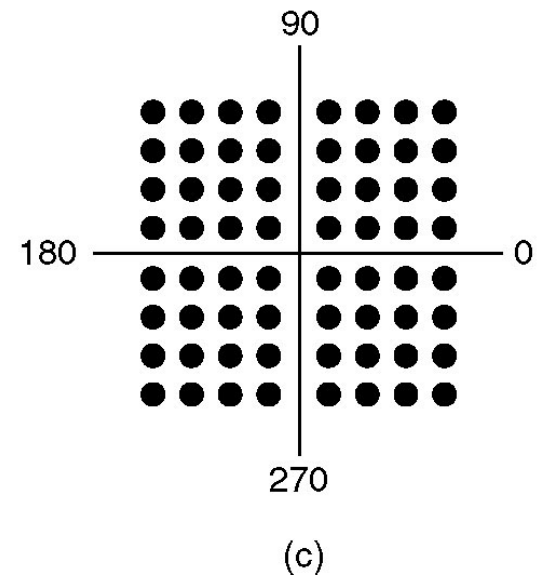

(c) QAM-64.

Figure 2-25.

Digital Data, Digital Signals

[the technique used in a number of LANs]

- Digital signal – is a sequence of discrete, discontinuous voltage pulses.
- Bit duration :: the time it takes for the transmitter to emit the bit.
- Issues
 - Bit timing
 - Recovery from signal
 - Noise immunity

NRZ (Non-Return-to-Zero) Codes

Uses two different voltage levels (one positive and one negative) as the signal elements for the two binary digits.

NRZ-L (**N**on-**R**eturn-**to**-**Z**ero-**L**evel)

The voltage is constant during the bit interval.

1 \Leftrightarrow negative voltage

0 \Leftrightarrow positive voltage

NRZ-L is used for short distances between terminal and modem or terminal and computer.

NRZ (Non-Return-to-Zero) Codes

NRZ-I (Non-Return-to-Zero-Invert on ones)

The voltage is constant during the bit interval.

1 \Leftrightarrow existence of a *signal transition* at the beginning of the bit time
(either a low-to-high or a high-to-low transition)

0 \Leftrightarrow **no *signal transition*** at the beginning of the bit time

NRZI is a *differential encoding* (i.e., the signal is decoded by comparing the polarity of adjacent signal elements.)

Bi -Phase Codes

Bi- phase codes – require at least one transition per bit time and may have as many as two transitions.

- the maximum modulation rate is twice that of NRZ
- greater transmission bandwidth is required.

Advantages:

Synchronization – with a predictable transition per bit time the receiver can “synch” on the transition [**self-clocking**].

No d.c. component

Error detection – the absence of an expected transition can be used to detect errors.

Manchester Encoding

- There is **always** a mid-bit transition { which is used as a clocking mechanism }.
- The **direction** of the mid-bit transition represents the digital data.

1 \Leftrightarrow **low-to-high** transition

0 \Leftrightarrow **high-to-low** transition

**Textbooks
disagree
on this
definition!!**

Consequently, there may be a second transition at the beginning of the bit interval.

Used in 802.3 baseband coaxial cable and CSMA/CD twisted pair.

Differential Manchester Encoding

- mid-bit transition is **ONLY** for clocking.

1 \Leftrightarrow **absence** of transition at the beginning of the bit interval

0 \Leftrightarrow **presence** of transition at the beginning of the bit interval

Differential Manchester is both differential and bi-phase.

Note – the coding is the opposite convention from NRZI.

Used in 802.5 (token ring) with twisted pair.

- * Modulation rate for Manchester and Differential Manchester is **twice** the data rate \rightarrow inefficient encoding for long-distance applications.

Bi-Polar Encoding

1 \Leftrightarrow **alternating** +1/2 , -1/2 voltage
0 \Leftrightarrow **0** voltage

- Has the same issues as NRZI for a long string of 0's.
- A systemic problem with polar is the polarity can be backwards.

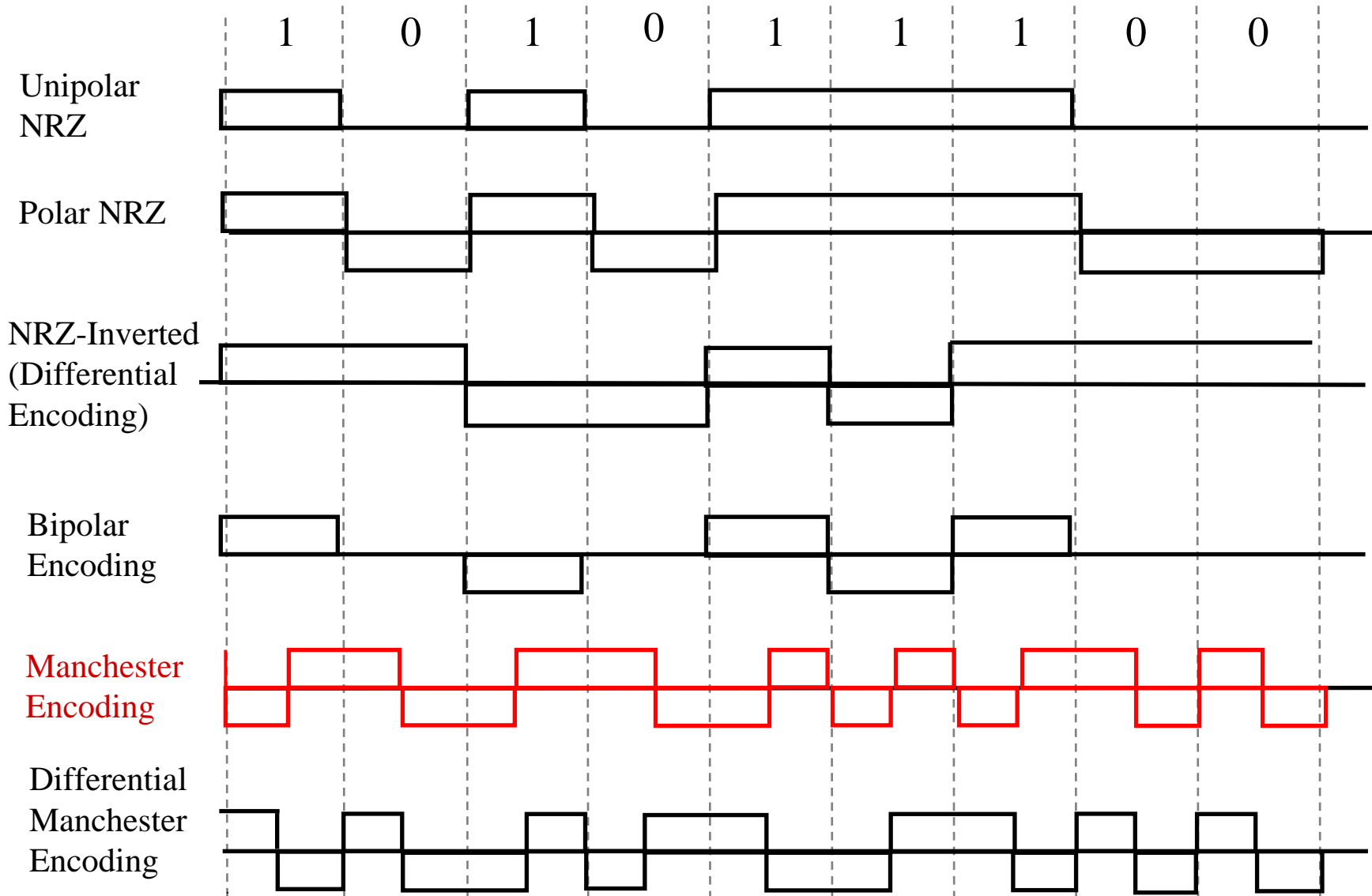

Analog Data, Digital Signals

[Example - PCM (Pulse Code Modulation)]

The most common technique for using digital signals to encode analog data is PCM.

*Example: To transfer analog voice signals off a local loop to digital end office within the phone system, one uses a **codec**.*

Because voice data limited to frequencies below 4000 HZ, a codec makes 8000 samples/sec. (i.e., 125 microsec/sample).

Multiplexing

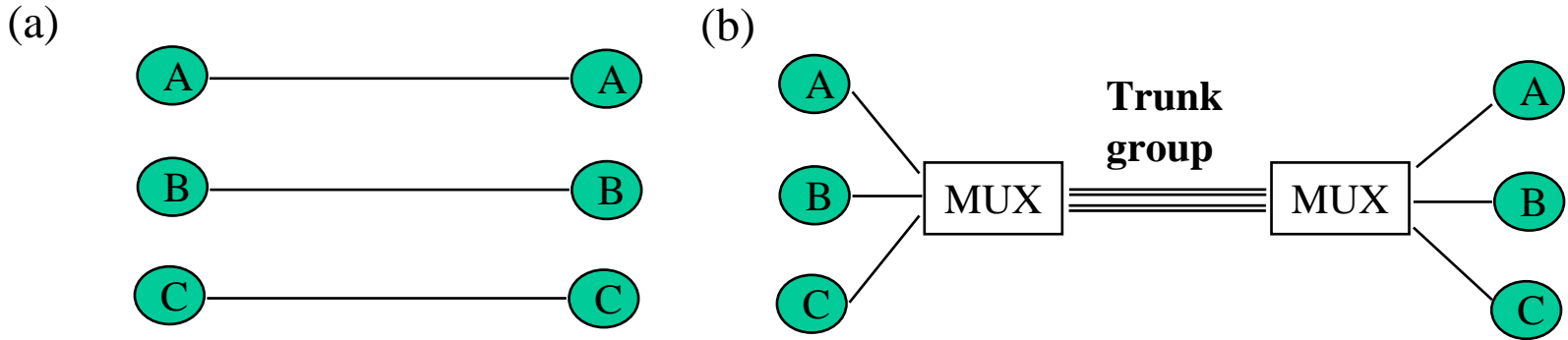

Frequency-division Multiplexing

(a) Individual signals occupy H Hz

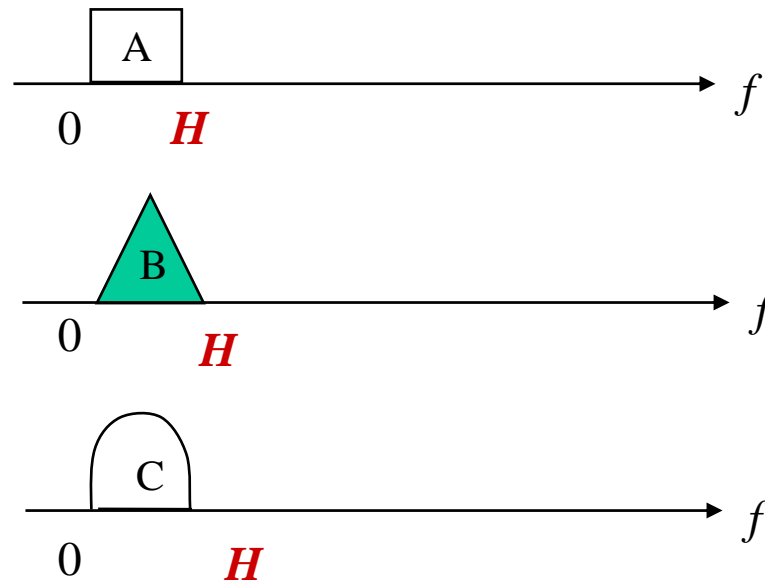

(b) Combined signal fits into channel bandwidth

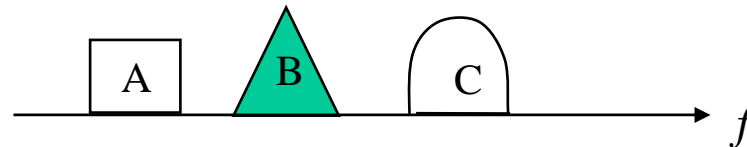

Frequency-division Multiplexing

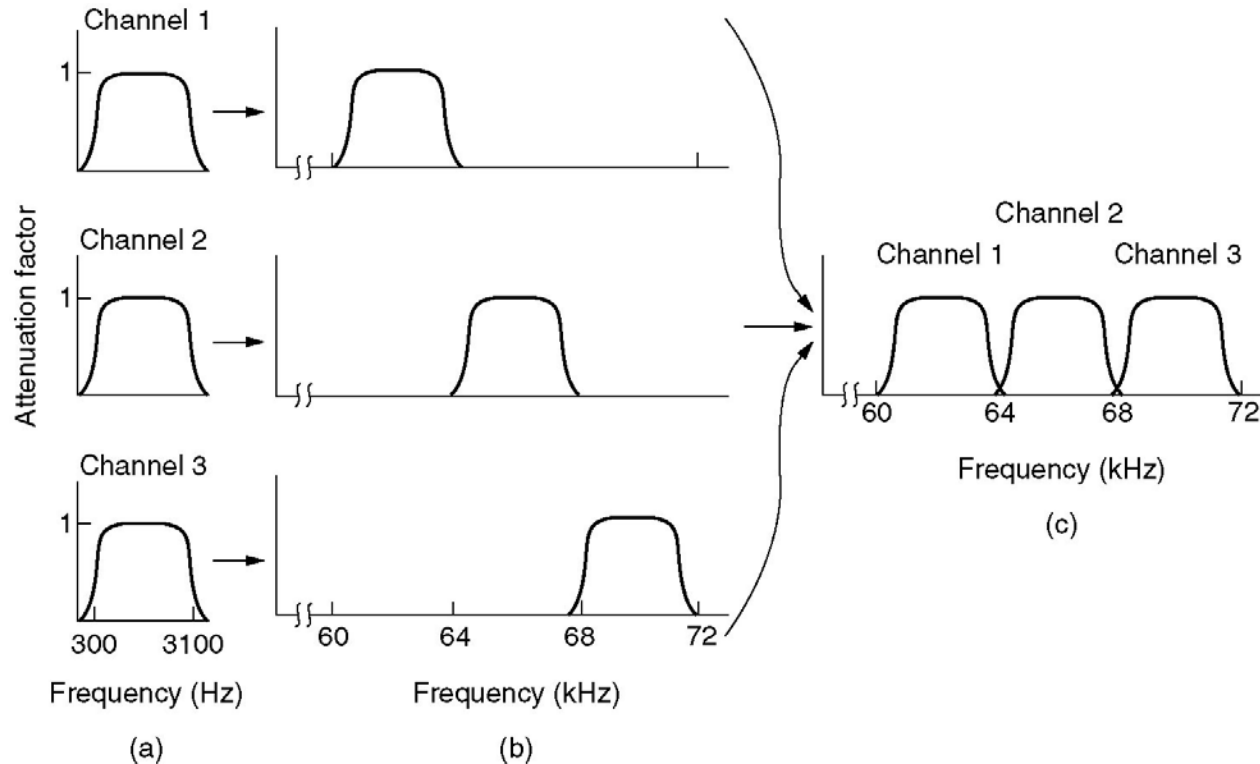

Figure 2-31. (a) The original bandwidths. (b) The bandwidths raised in frequency. (c) The multiplexed channel.

Wavelength Division Multiplexing

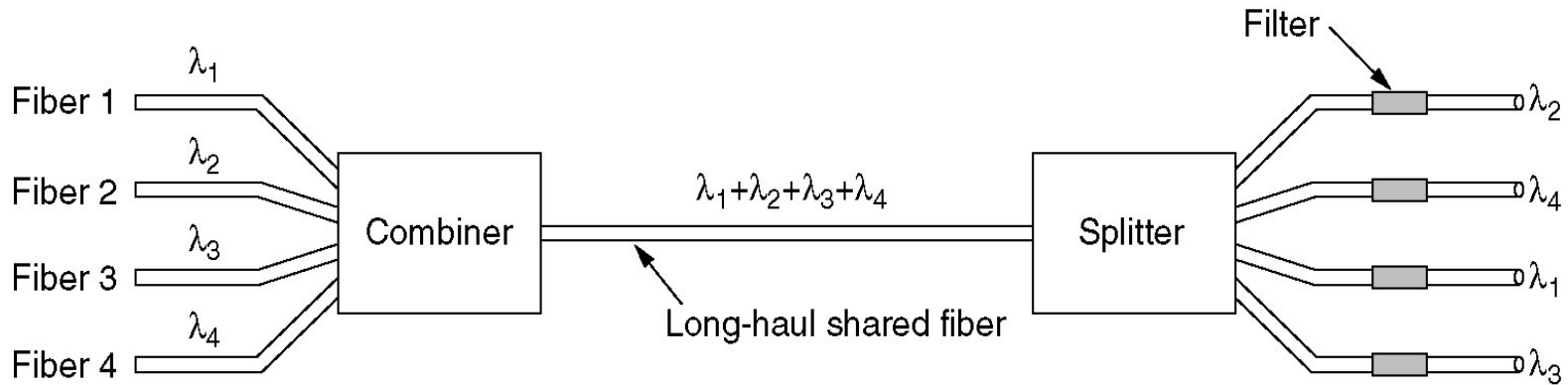
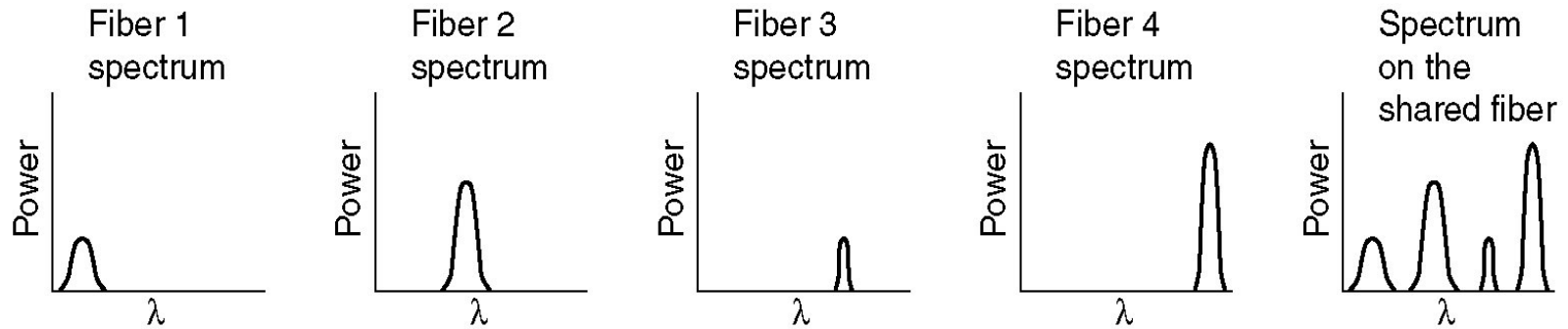
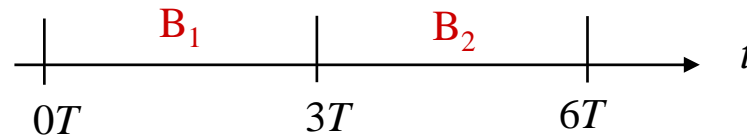
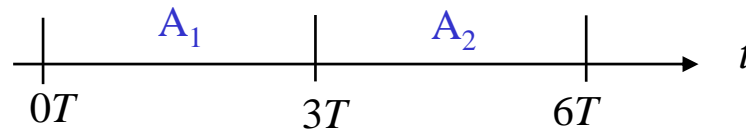

Figure 2-32.

Time-division Multiplexing

(a) Each signal transmits 1 unit every $3T$ seconds



(b) Combined signal transmits 1 unit every T seconds

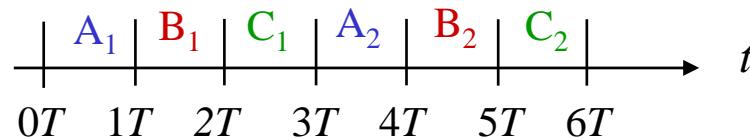

Time-division Multiplexing

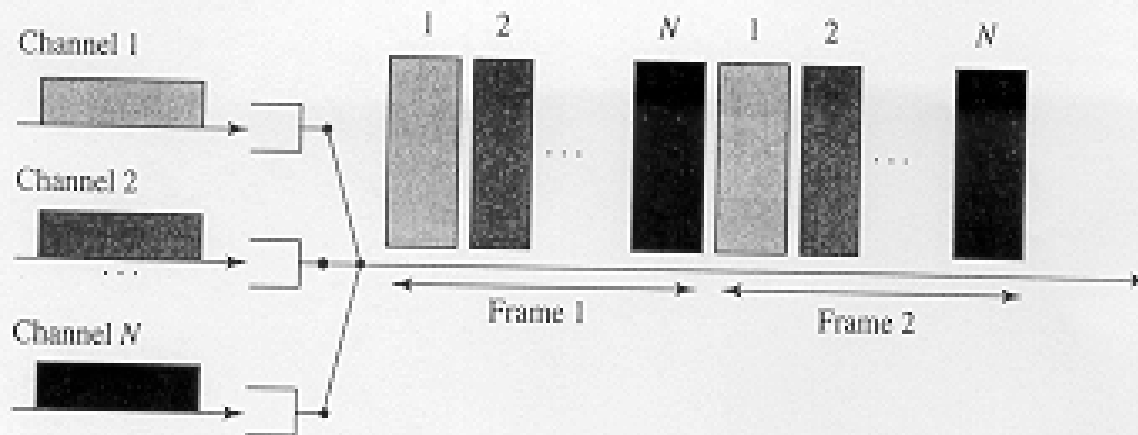

2.9

FIGURE

When a communication link is shared by time-division multiplexing, time is divided into frames. Each frame is divided into time slots that are allocated in a fixed order to the different incoming channels.

Statistical Multiplexing - Concentrator

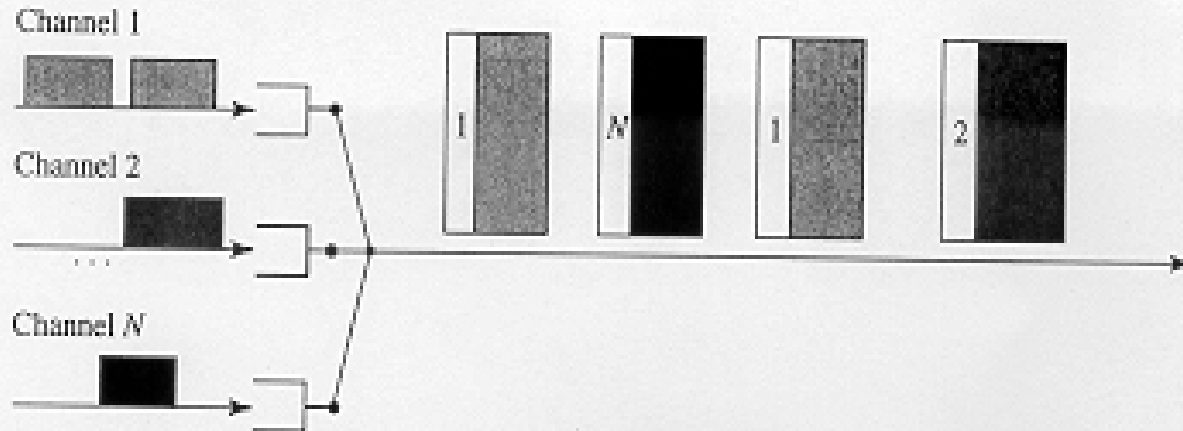

2.10

FIGURE

In statistical multiplexing, the multiplexer visits the incoming channel buffers in some order. The multiplexer empties a buffer before moving to the next one. The buffer contents are tagged to indicate their incoming channel. An idle channel does not waste transmission time.

Pulse Code Modulation (PCM)

- Analog signal is sampled.
- Converted to discrete-time continuous-amplitude signal (Pulse Amplitude Modulation)
- Pulses are *quantized* and assigned a digital value.
 - A 7-bit sample allows 128 quantizing levels.

Pulse Code Modulation (PCM)

- PCM uses non-linear encoding, i.e., amplitude spacing of levels is non-linear.
 - There is a greater number of quantizing steps for low amplitude.
 - This reduces overall signal distortion.
- This introduces *quantizing error (or noise)*.
- PCM pulses are then encoded into a digital bit stream.
- 8000 samples/sec x 7 bits/sample = 56 Kbps for a single voice channel.

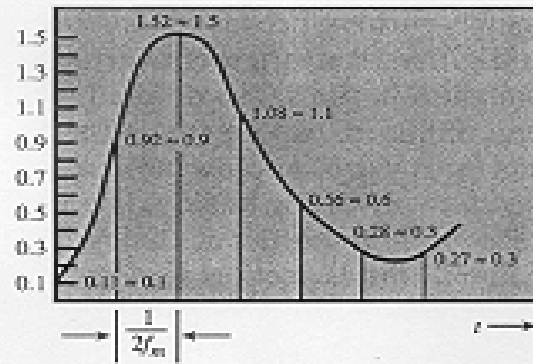

(a)

Digit	Binary equivalent	PCM waveform
0	0000	Low level
1	0001	Low level, then high level
2	0010	Low level, then high level, then low level
3	0011	Low level, then high level, then low level, then high level
4	0100	Low level, then high level, then low level, then low level
5	0101	Low level, then high level, then low level, then high level
6	0110	Low level, then high level, then high level, then low level
7	0111	Low level, then high level, then high level, then high level
8	1000	High level, then low level, then low level, then low level
9	1001	High level, then low level, then low level, then high level
10	1010	High level, then low level, then high level, then low level
11	1011	High level, then low level, then high level, then high level
12	1100	High level, then high level, then low level, then low level
13	1101	High level, then high level, then low level, then high level
14	1110	High level, then high level, then high level, then low level
15	1111	High level, then high level, then high level, then high level

(b)

Figure 5.10 Pulse Code Modulation

PCM

Nonlinear Quantization Levels

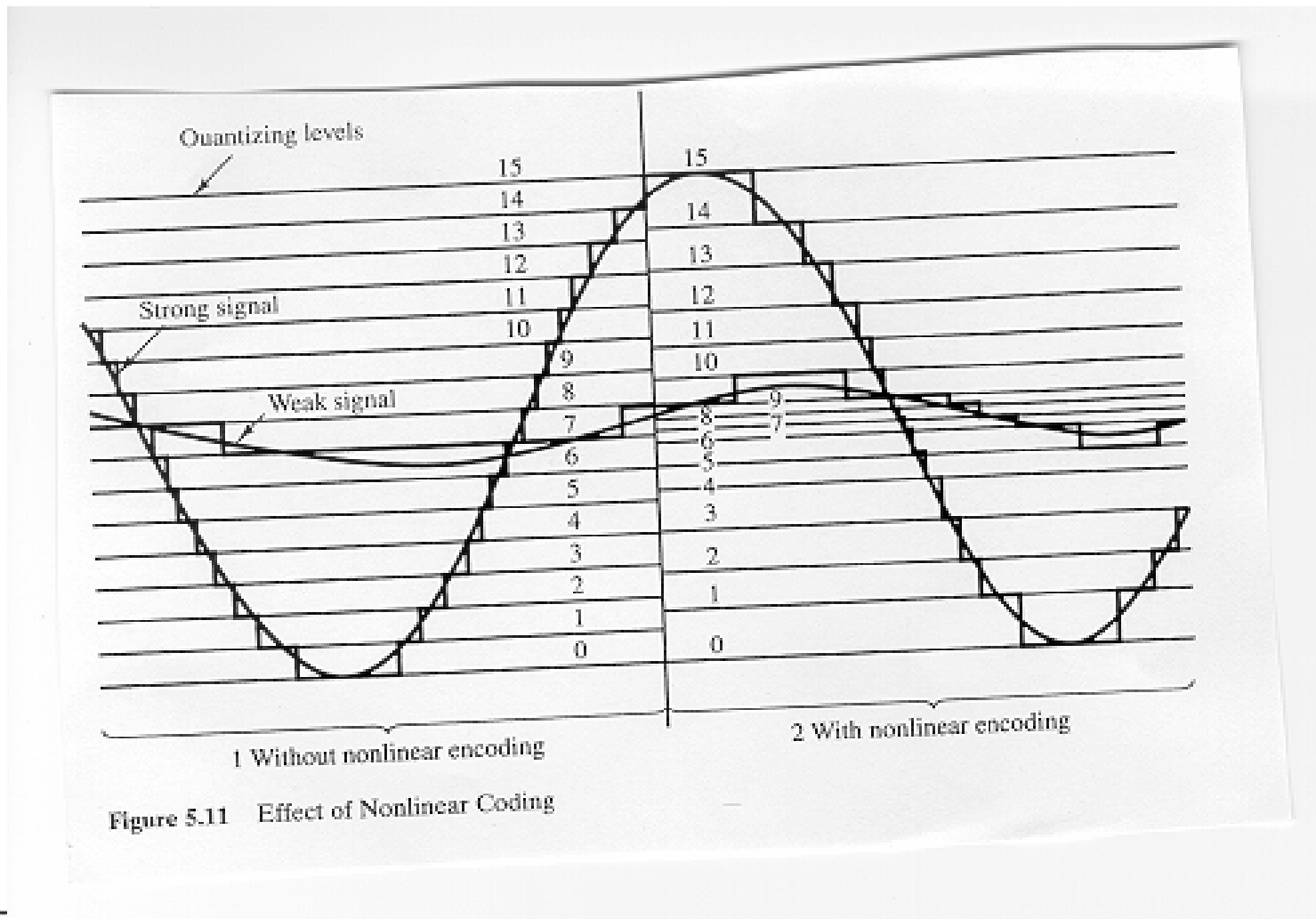

T1 System

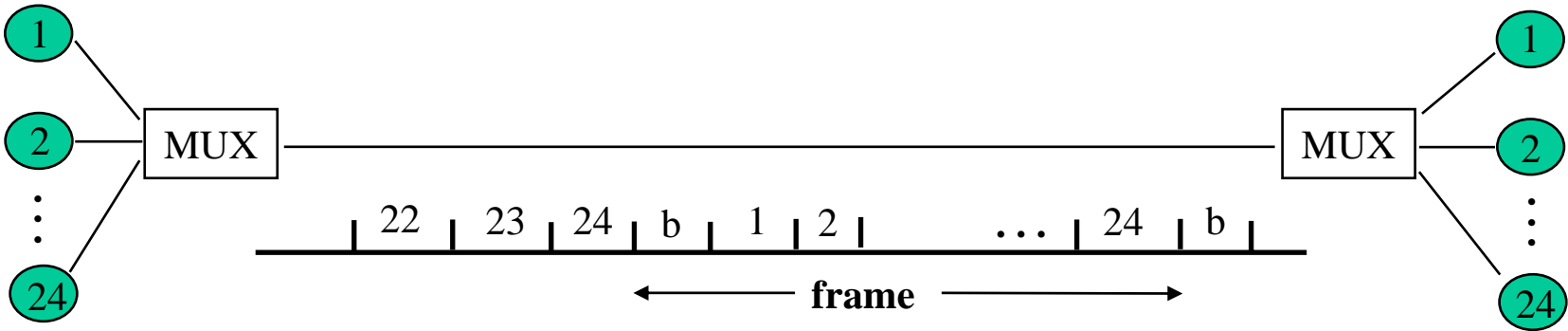

TDM

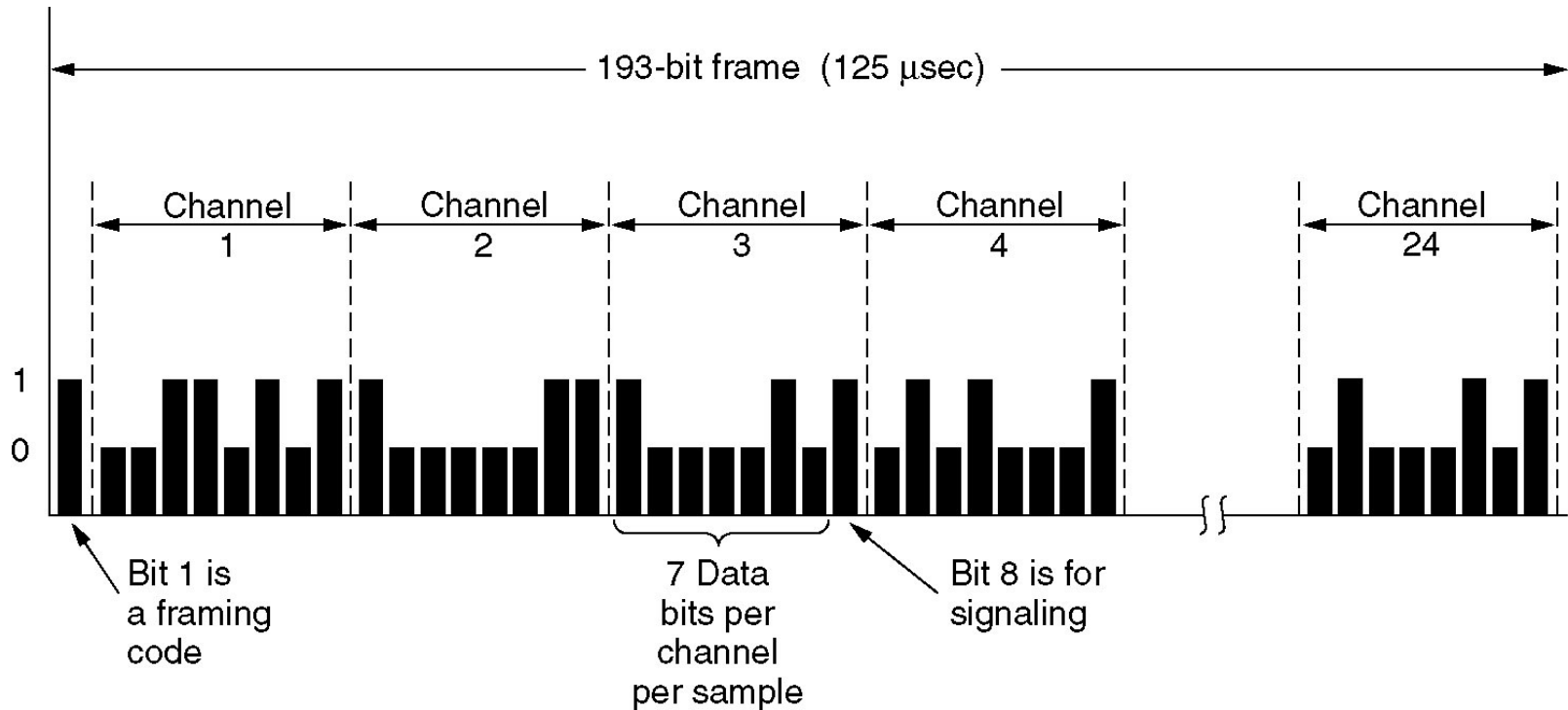

Figure 2-33. T1 Carrier (1.544Mbps)

Delta Modulation (DM)

- The basic idea in *delta modulation* is to approximate the derivative of analog signal rather than its amplitude.
- The analog data is approximated by a staircase function that moves up or down by one quantization level at each sampling time. → output of DM is a single bit.
- PCM preferred because of better SNR characteristics.

Delta Modulation DCC 6th Ed. W.Stallings

