

Ethernet

Ethernet [DEC, Intel, Xerox]

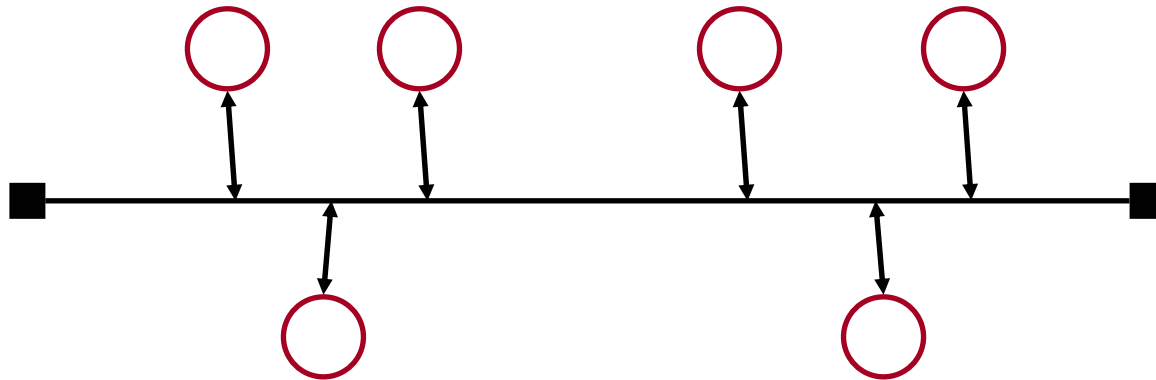

- 1-persistent, CSMA-CD with Binary Exponential Backoff.
- Manchester encoding.

Ethernet [operational in 1974]

Initially 3 Mbps baseband coaxial cable (thick Ethernet).

Operational Description

- *Ethernet stations sense the channel.*
- *When the channel is free the station transmits a frame.*
- *The stations monitor the ‘ether’ during the transmission.*
- *If a collision is detected by any station, the transmission is terminated immediately and a jam signal is sent.*
- *Upon collision, transmitting stations backoff using a local counter and then retransmit.*

Collision Detection [worst case]

A begins to transmit at $t=0$

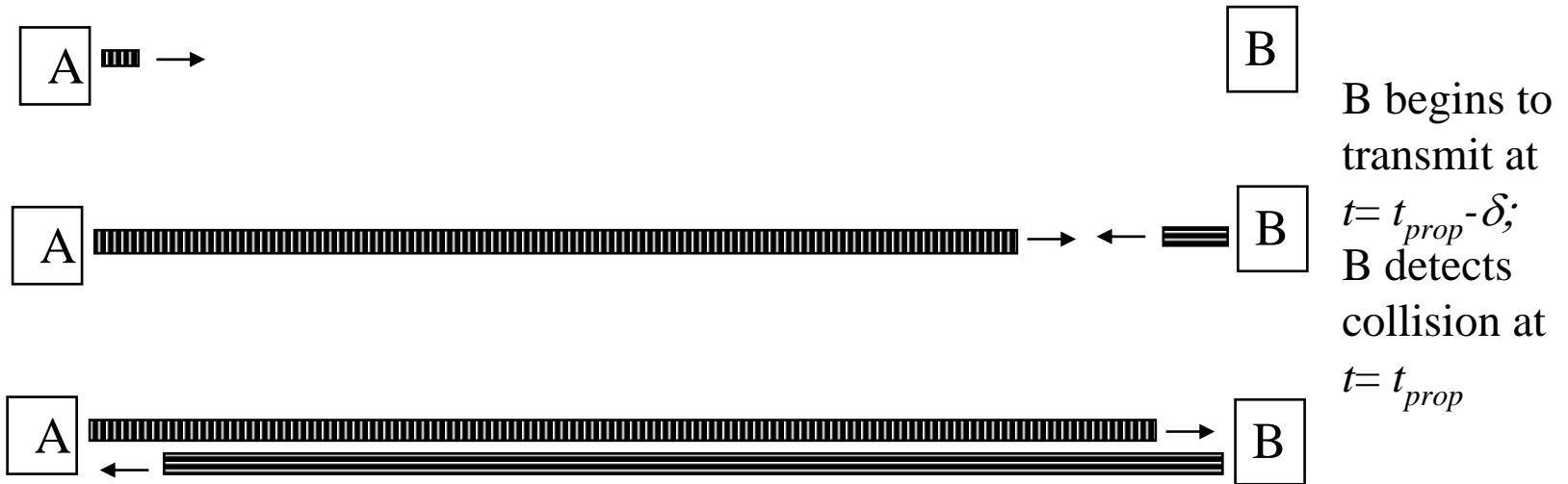

A detects collision at $t = 2t_{prop} - \delta$

It takes $2t_{prop}$ to find out if channel has been captured

Ethernet

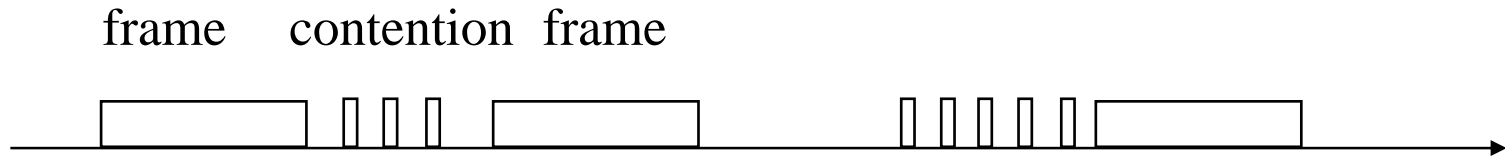

Figure 6.23

- A frame *seizes the channel after* $2 t_{prop}$
- On 1 km Ethernet, t_{prop} is approximately 5 microseconds.
- Contention interval = $2 t_{prop}$
- ***Interframe gap = 9.6 microseconds***
- Modeled as *slotted scheme* with slot = $2 t_{prop}$

Binary Exponential Backoff

- Upon a collision, the *sending stations* increment a local counter **K**. The backoff interval is randomly selected using a uniform distribution over the $L = 2^K$ slots.
- **K** is initially set to 0.
- Thus upon collision, the value of L is doubled locally for each *sending station*.

Binary Exponential Backoff (BEB)

Slotted ALOHA has been shown to be unstable when

$$p > 1/n$$

Since Ethernet permits up to 1024 stations, backoff continues until $K = 10$, $L = 2^{10}$, and $p = 1/2^{10}$

Normally K is incremented up to 10, but BEB is set for 16 retries. After 16 retries, MAC gives up trying to send the frame.

← **802.3 MAC Frame** →

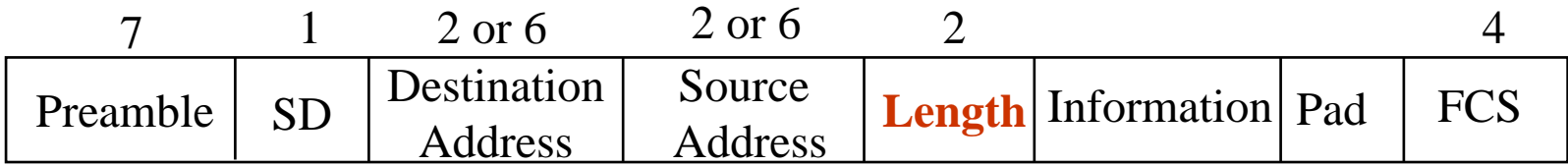

Synch

Start
frame

64 to 1518 bytes

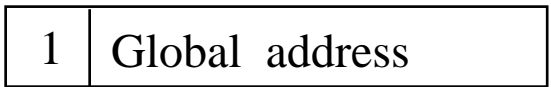
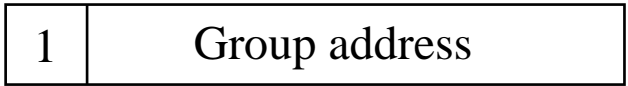

- Destination address is either single address or group address (broadcast = 111...111)

- Addresses are defined on local or universal basis
- 2^{46} possible global addresses



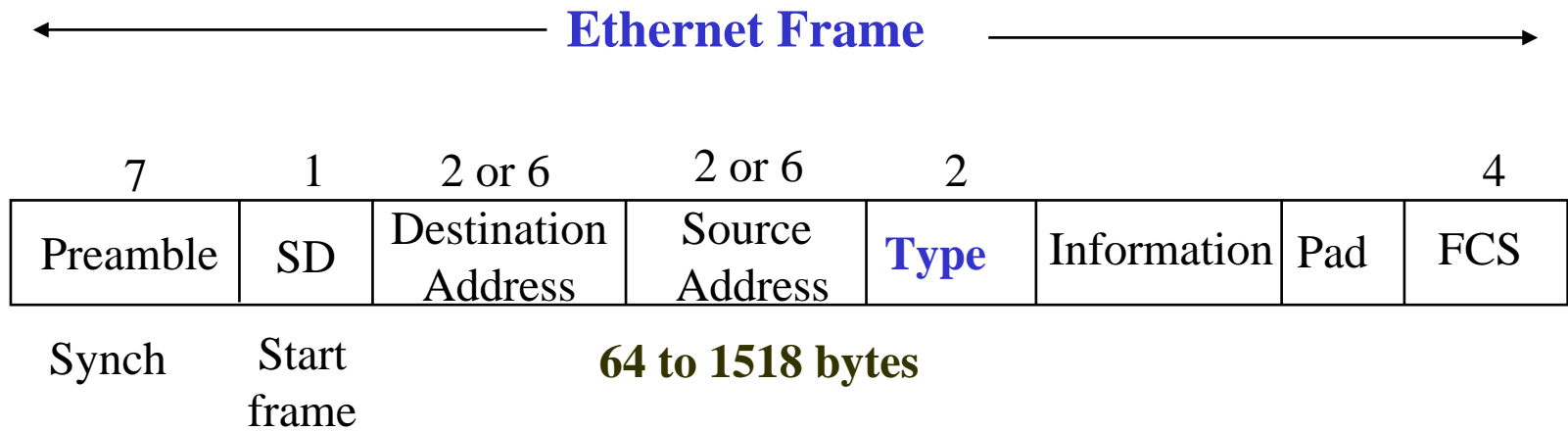

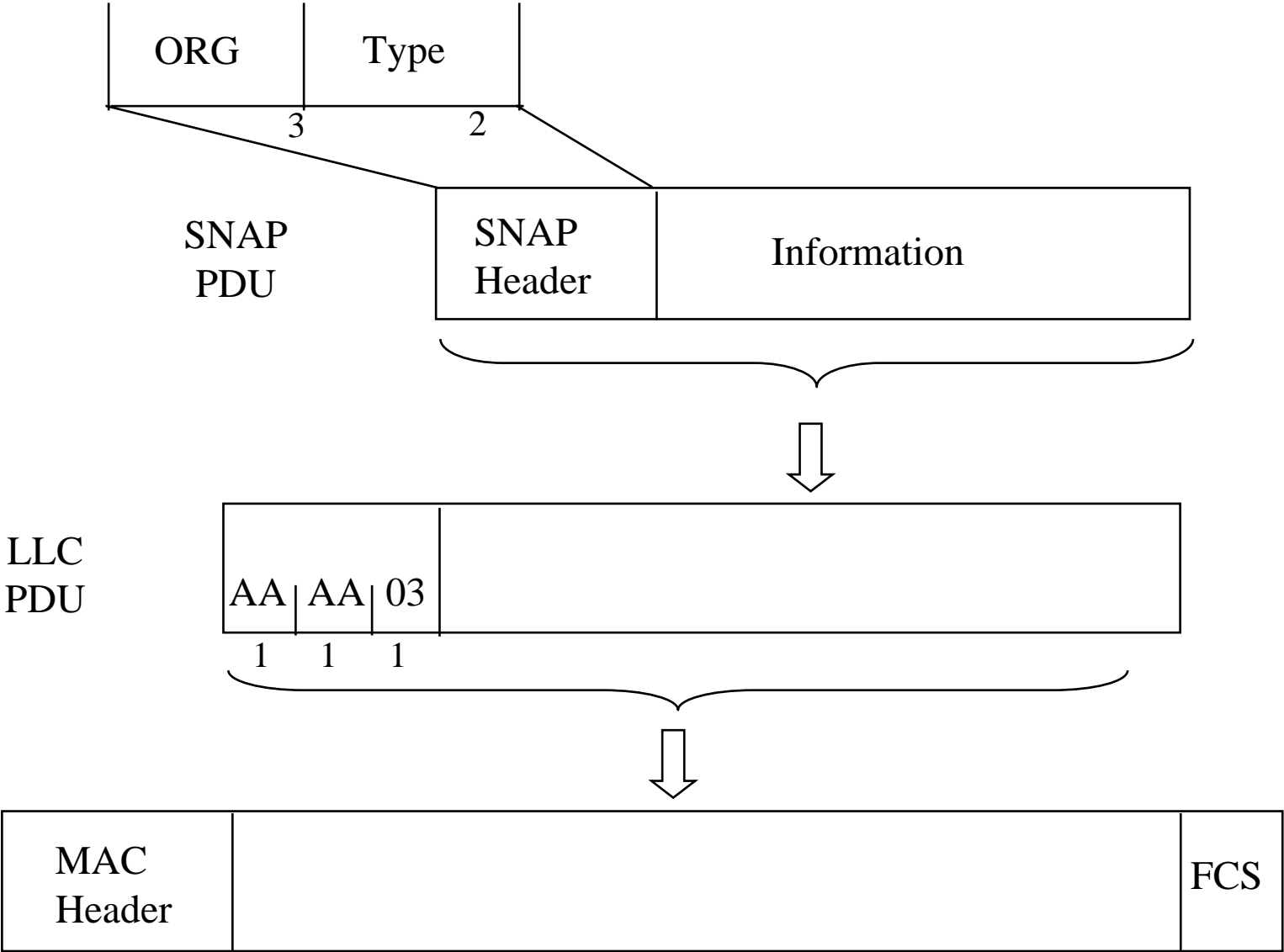

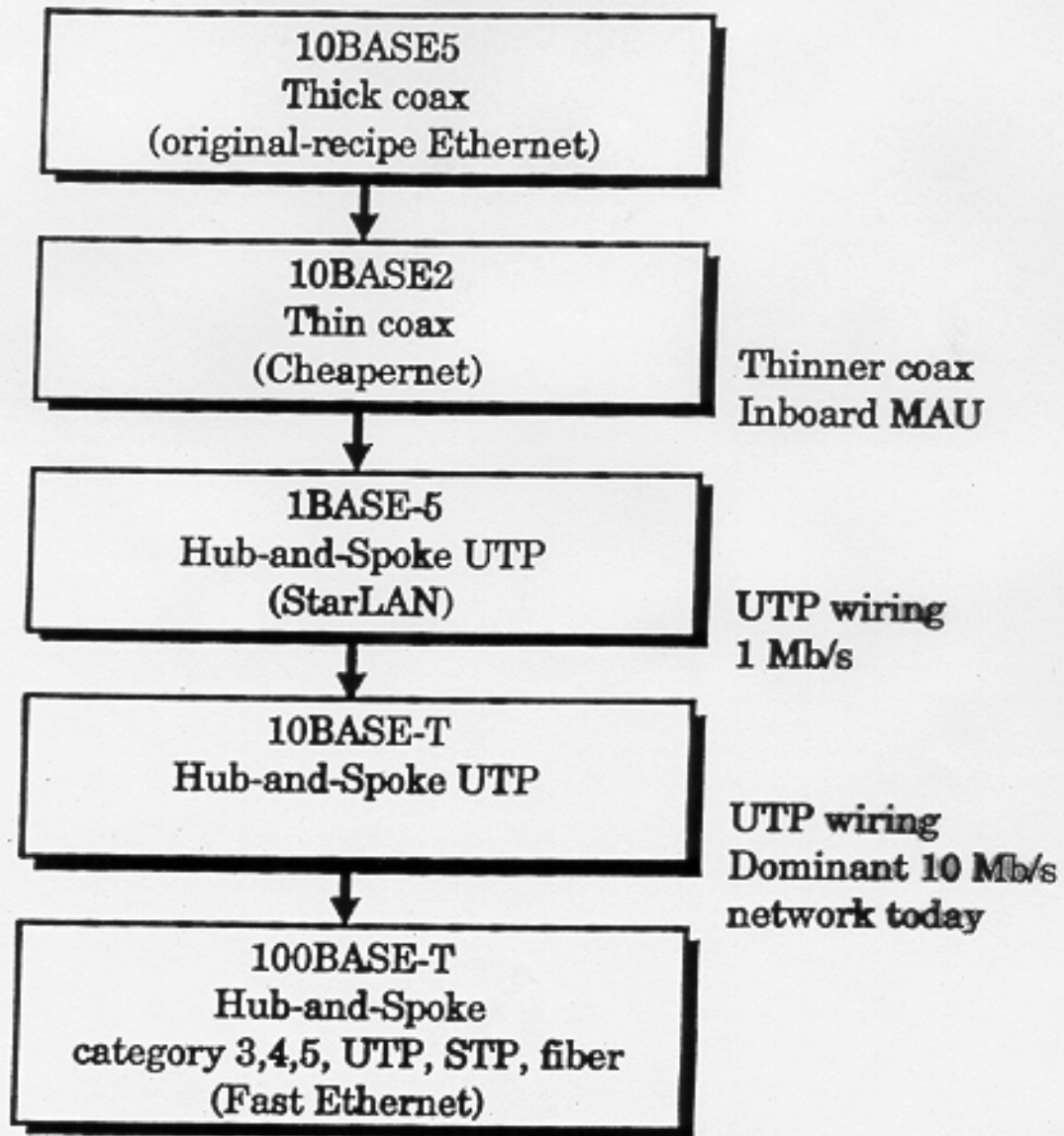

Figure 1.4 Lineage of Fast Ethernet



Ethernet Evolution

10BASE5

{1983}

- 10 Mbps
 - 500 meter segment length
 - Signal-regenerating repeaters
 - **Thick Coax**
 - *Advantages*: Low attenuation, excellent noise immunity, superior mechanical strength
 - *Disadvantages*: Bulky, difficult to pull, transceiver boxes too expensive
- * *Wiring represented a significant part of total installed cost.*

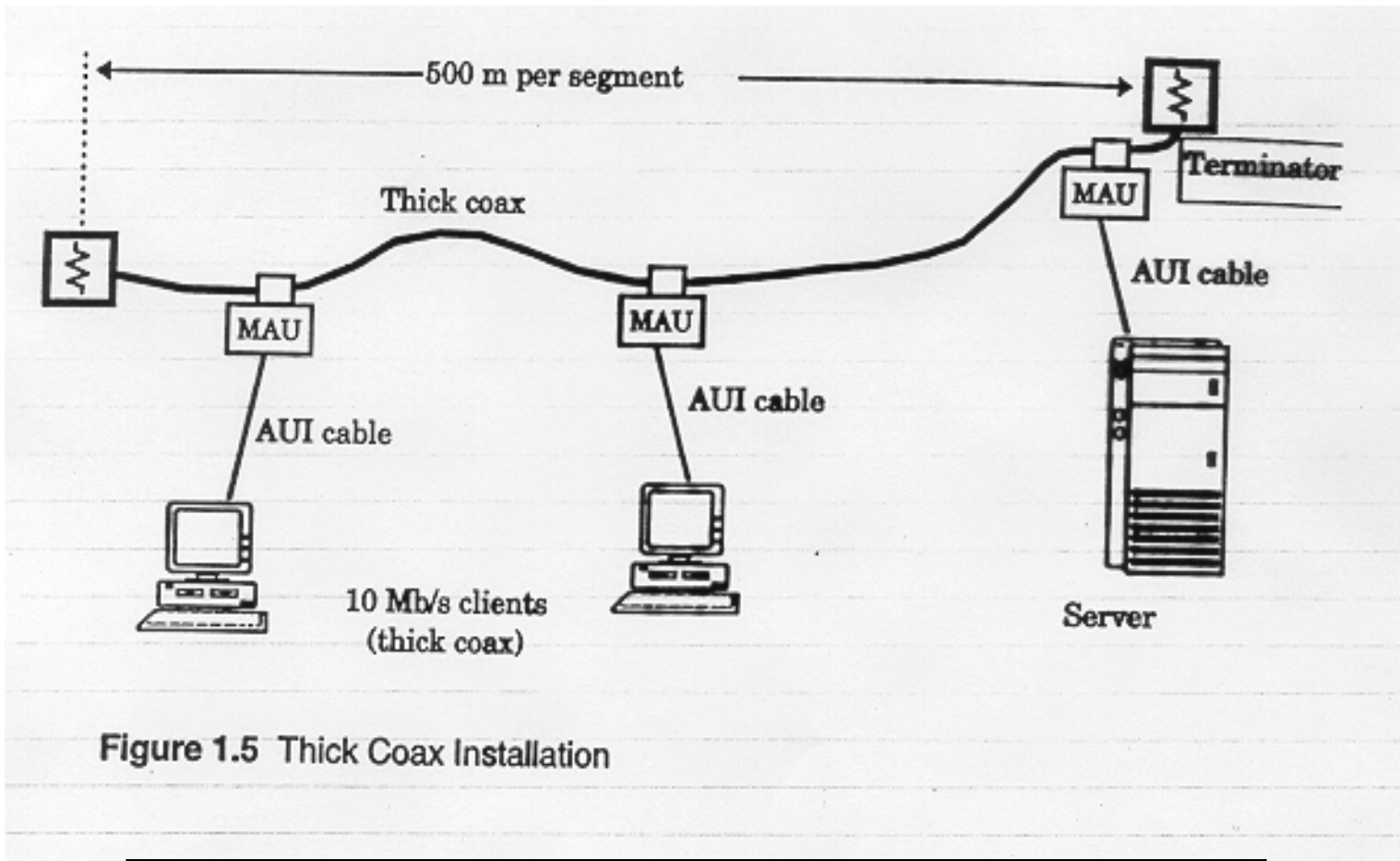

Figure 1.5 Thick Coax Installation

MAU device is physically hooked on main cable.
 50 meter AUI cable from MAU to station.

Ethernet Evolution

10BASE2 *Cheaper*net {1985}

- 10 Mbps
- 185 meter segment length
- Signal-regenerating repeaters
- Transceiver was integrated onto the adapter
- **Thin Coax (coax thinner and lighter)**
 - *Advantages*: Easier to install, reduced hardware cost, BNC connectors widely deployed → lower installation costs.
 - *Disadvantages*: Attenuation not as good, could not support as many stations due to signal reflection caused by BNC Tee Connector.

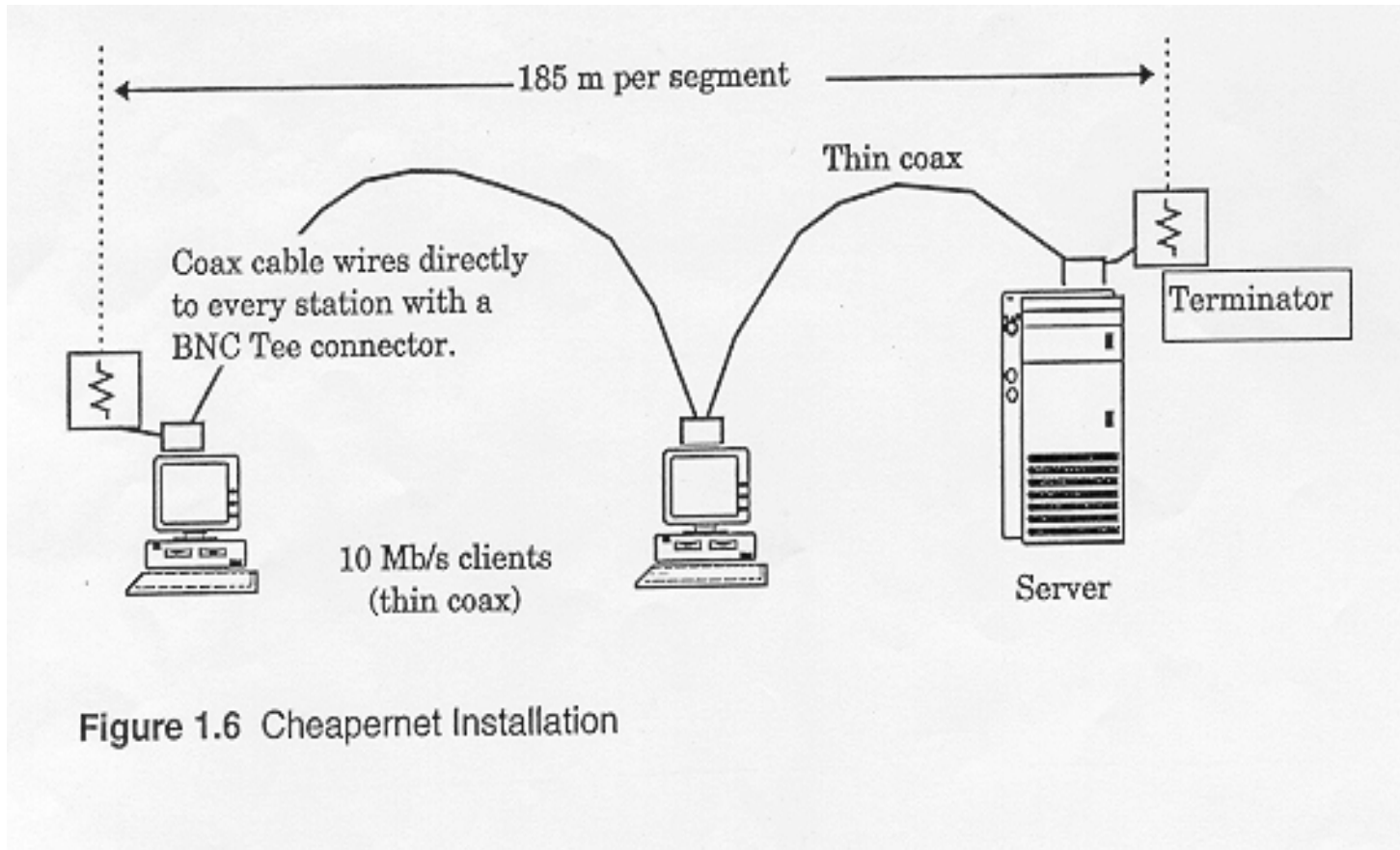

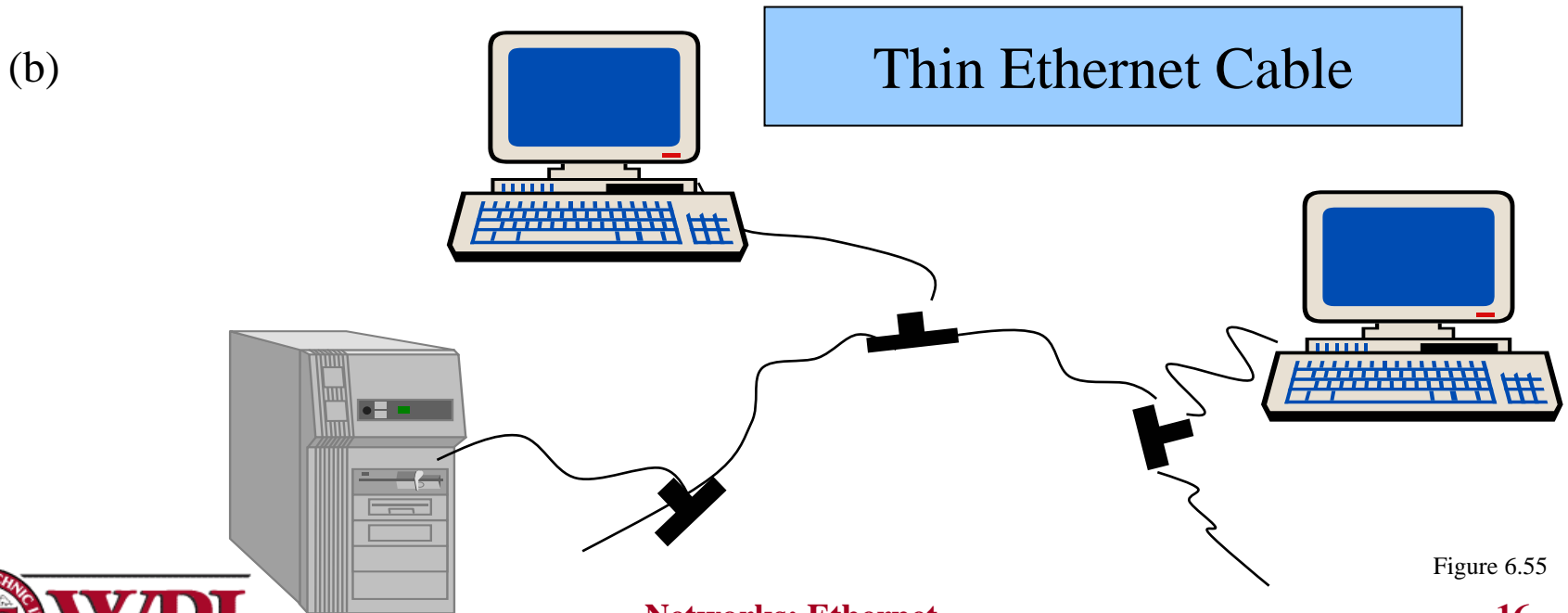
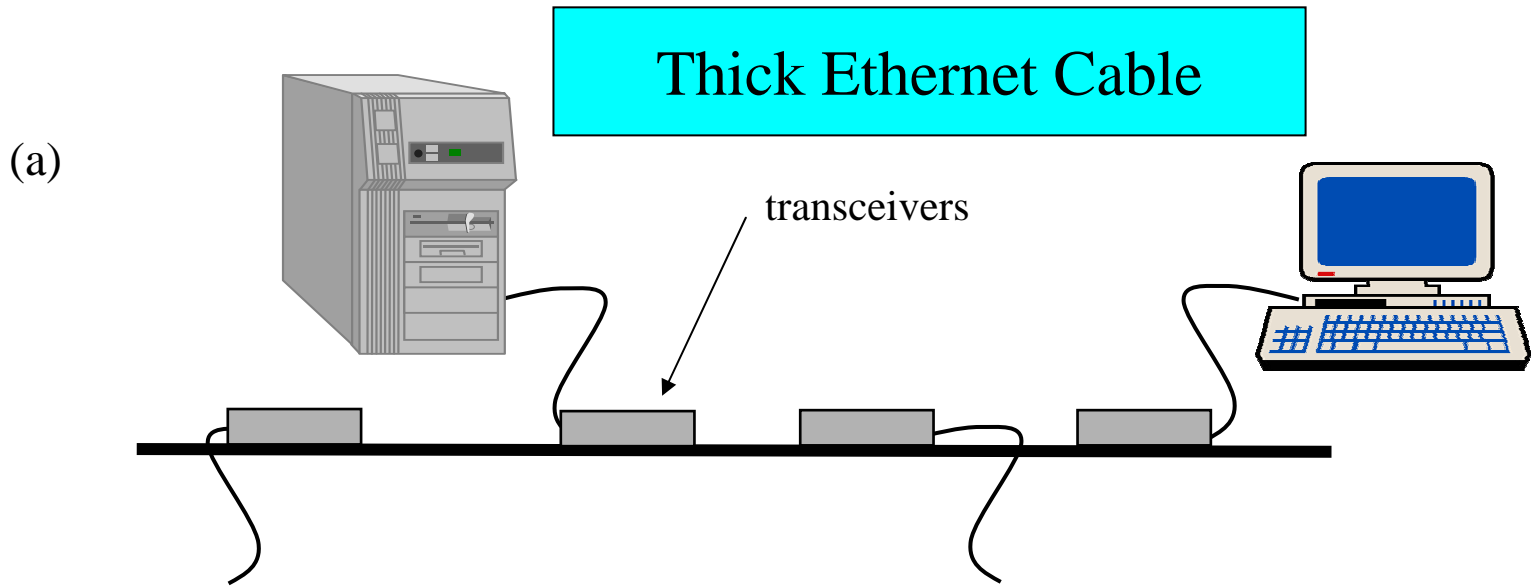

Figure 6.55

Ethernet Evolution

1BASE5 *StarLAN*

{1987}

- 1 Mbps
- 250 meter segment length
- Signal-regenerating repeaters
- Transceiver integrated onto the adapter
- Hub-and-Spoke topology (star topology)
- **Two pairs of unshielded twisted pair**
 - *Advantages: Since four or more UTP are ubiquitous in buildings, it is easier to use installed wiring in the walls. Telephone wiring is hierarchical → can use wiring closets.*

Ethernet Evolution

10BASET {1990} **Most popular

- 10 Mbps
- 100 meter segment length
- Signal-regenerating repeaters
- Transceiver integrated onto adapter
- Two pairs of UTP
- Hub-and-spoke topology {Hub in the closet}
 - *Advantages:* could be done without pulling new wires.
Each hub amplifies and restores incoming signal.

The Hub Concept

- Separate transmit and receive pair of wires.
- The **repeater** in the hub retransmits the signal received from **any** input pair onto **ALL** output pairs.
- *Essentially the **hub** emulates a broadcast channel with collisions detected by receiving nodes.*

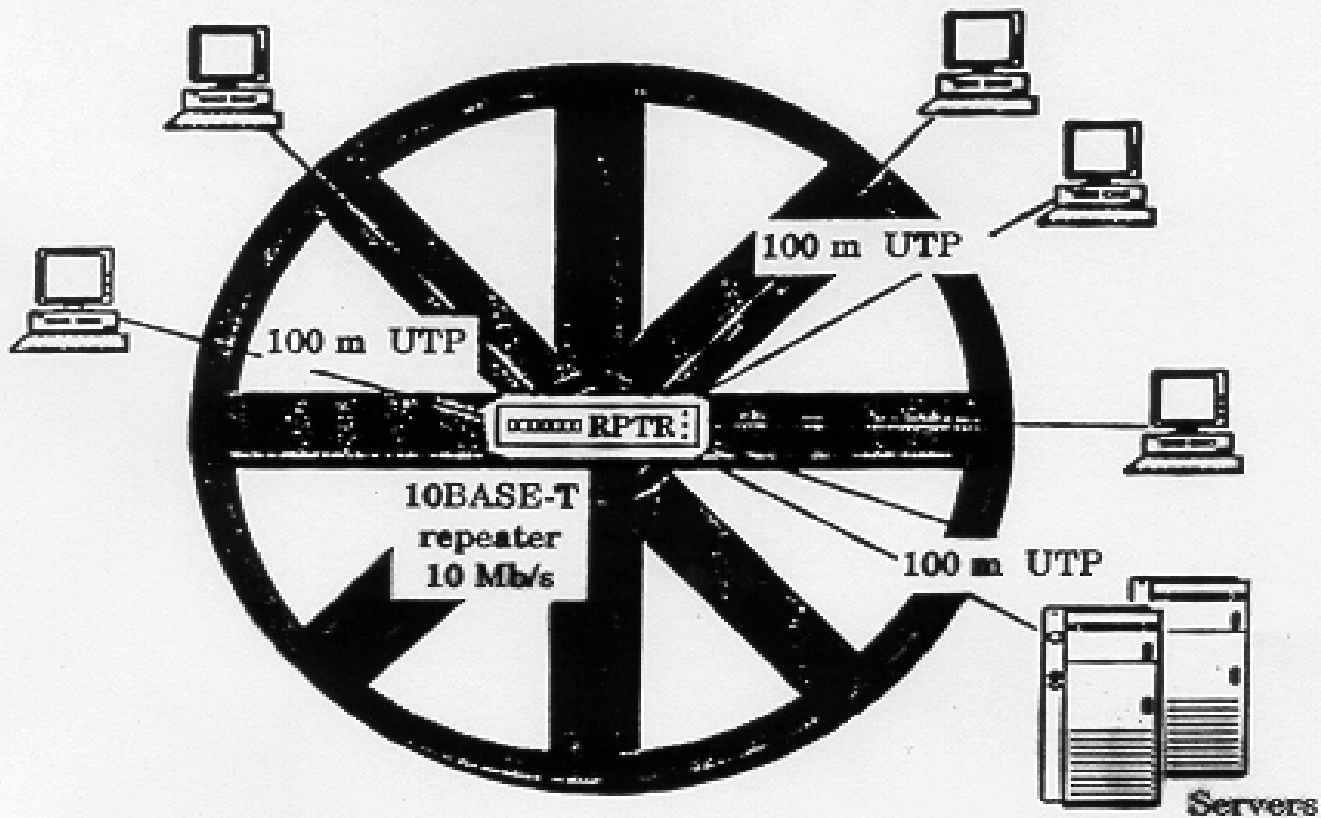
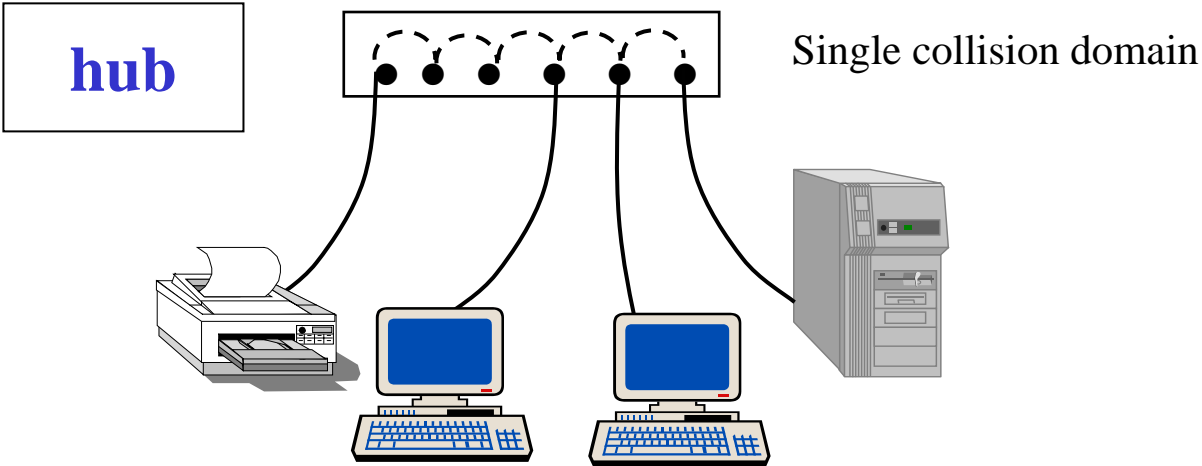

Figure 1.7 10BASE-T Hub-and-Spoke Architecture

Twisted Pair Ethernet

(a)



(b)

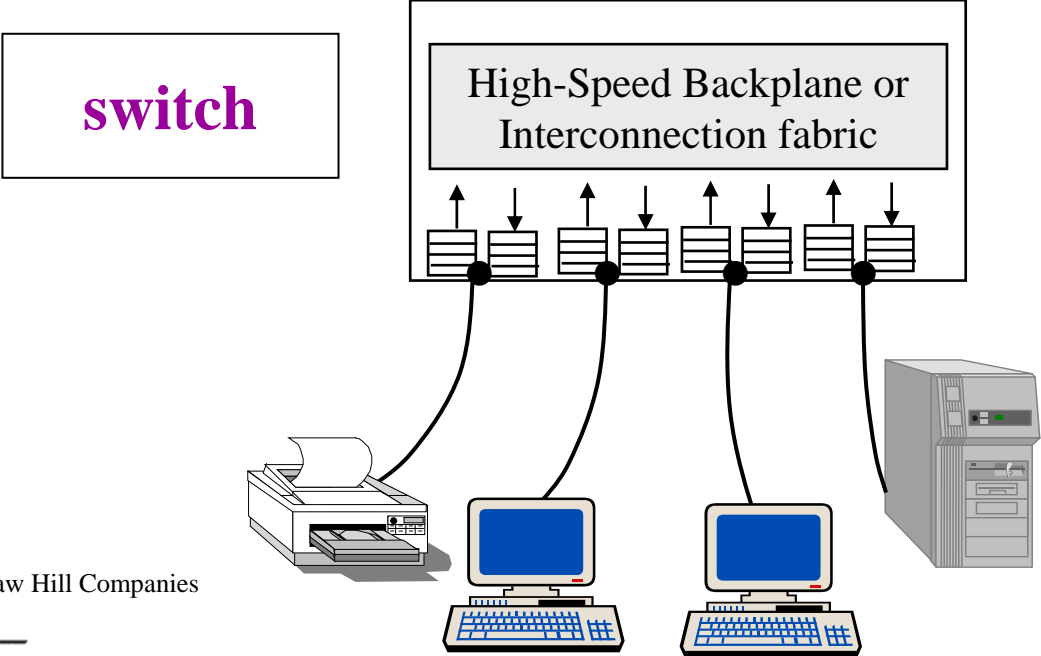

Copyright ©2000 The McGraw Hill Companies

Figure 6.56

Switched Ethernet

- * **Basic idea:** improve on the **Hub** concept
 - The switch *learns destination locations* by remembering the ports of the associated source address in a table.
 - The switch may not have to broadcast to all output ports. It may be able to send the frame **only** to the destination port.
 - → a big performance advantage over a hub, if more than one frame transfer can go through the switch concurrently.

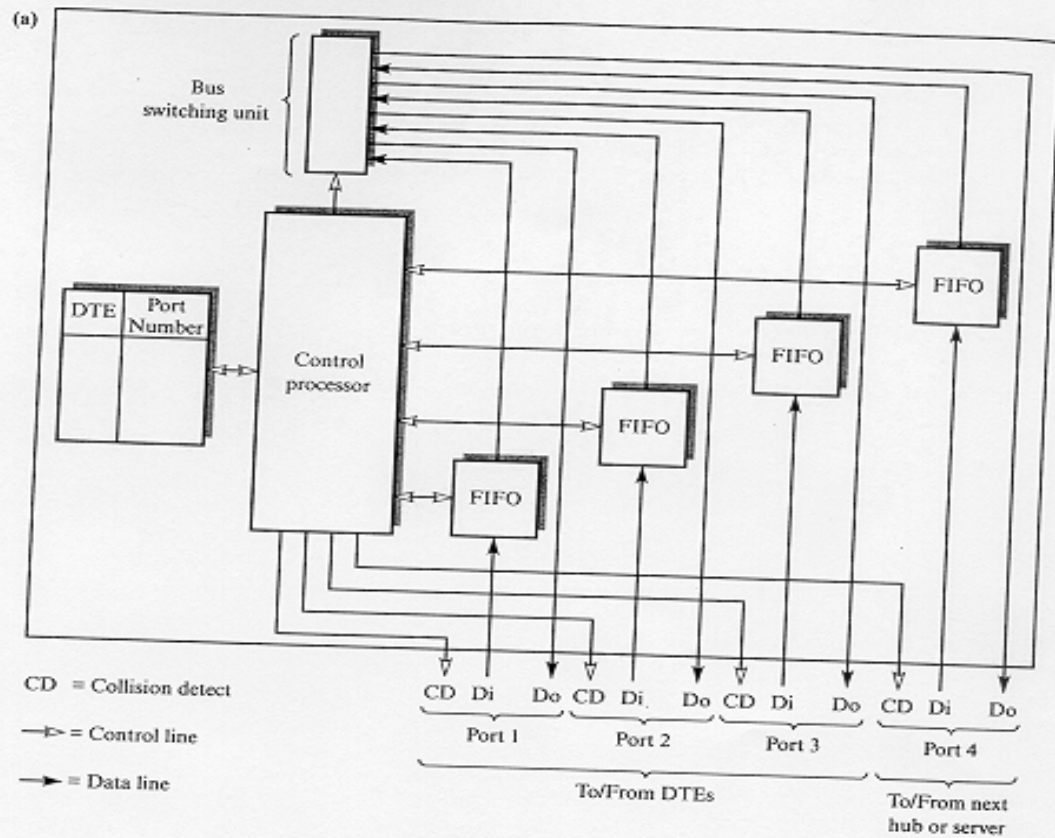

Figure 7.2
 Ethernet switching:
 (a) switching hub
 schematic;
 (b) switching hub
 derivative.

Switched Ethernet

- The advantage comes when the **switched Ethernet** backplane is able to repeat more than one frame in parallel (*a separate backplane bus line for each node*).
 - The frame is relayed onto the required output port via the port's own backplane bus line.
- Under this scheme *collisions are still possible* when two concurrently arriving frames are destined for the same station.
- **Note – each parallel transmission can take place at 10Mbps!!**

Switched Ethernet

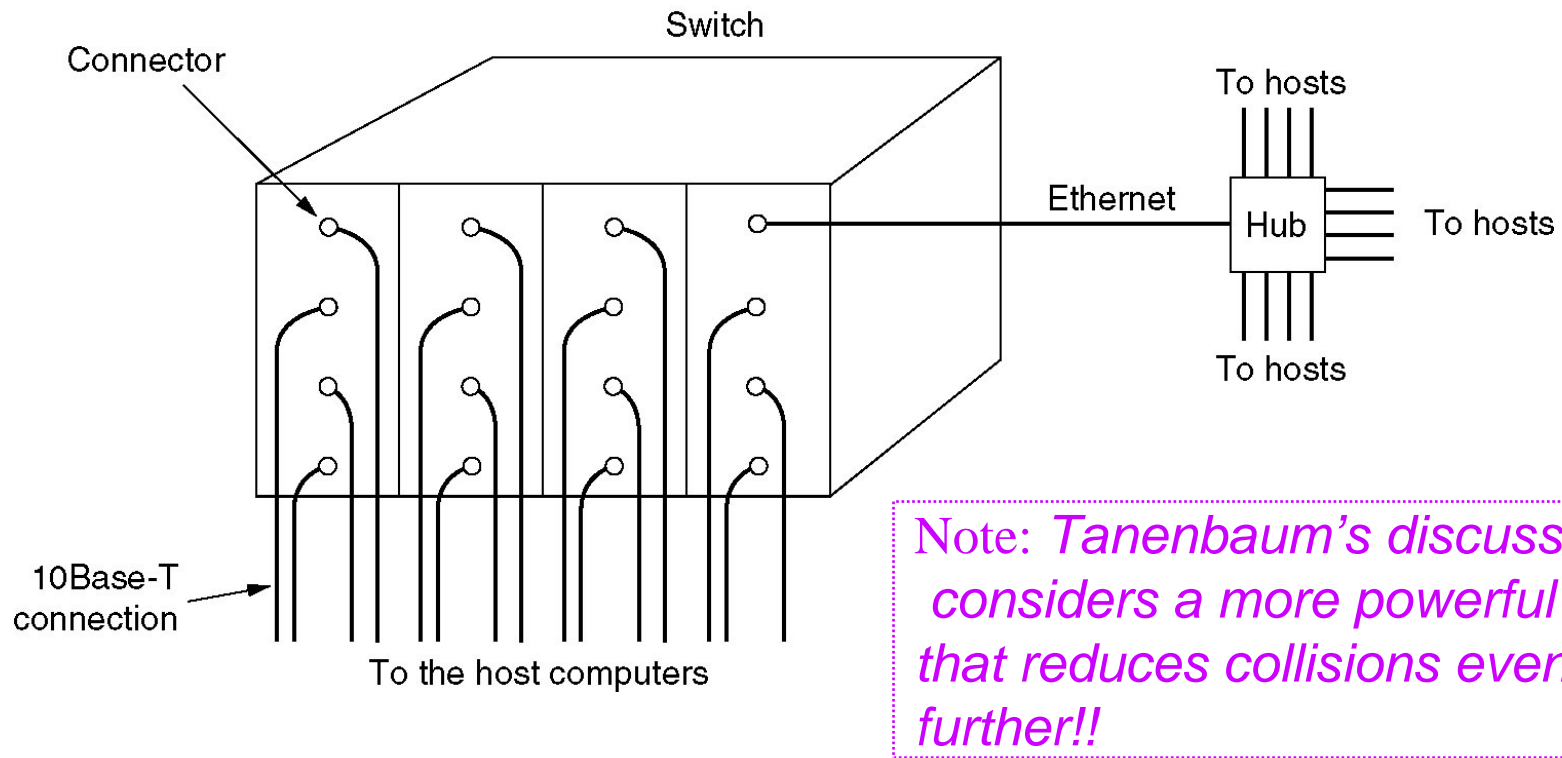

Figure 4-20. A simple example of switched Ethernet.

Switched Ethernet Hub

- Since servers are often shared by multiple nodes, one can employ a **switching hub** with a port which operates at a higher rate than the other ports.
 - ➔ This requires extra buffering inside the hub to handle speed mismatches.
- Can be further *enhanced* by higher rated port **full-duplex**.

