

Point-to-Point Network Switching



Point-to-Point Network Switching

- Circuit Switching, Message Switching, Packet Switching, Cell Switching
- Connection-Oriented versus Connectionless
- Virtual Circuit versus Datagram Networks
- Internal/External Abstractions



Point-to-Point Switching

- Circuit Switching
- Store-and -Forward Networks
 - Message Switching
 - Packet Switching
 - connection-oriented vs connectionless
 - virtual circuit vs datagram
 - Cell Switching



Circuit Switching

- Seeking out and establishing a physical copper path from end-to-end [historic definition] .
- Circuit switching implies the need to first *set up* a dedicated, end-to-end path for the connection *before* the information transfer takes place.
- Once the connection is made the only delay is propagation time.



Circuit Switching

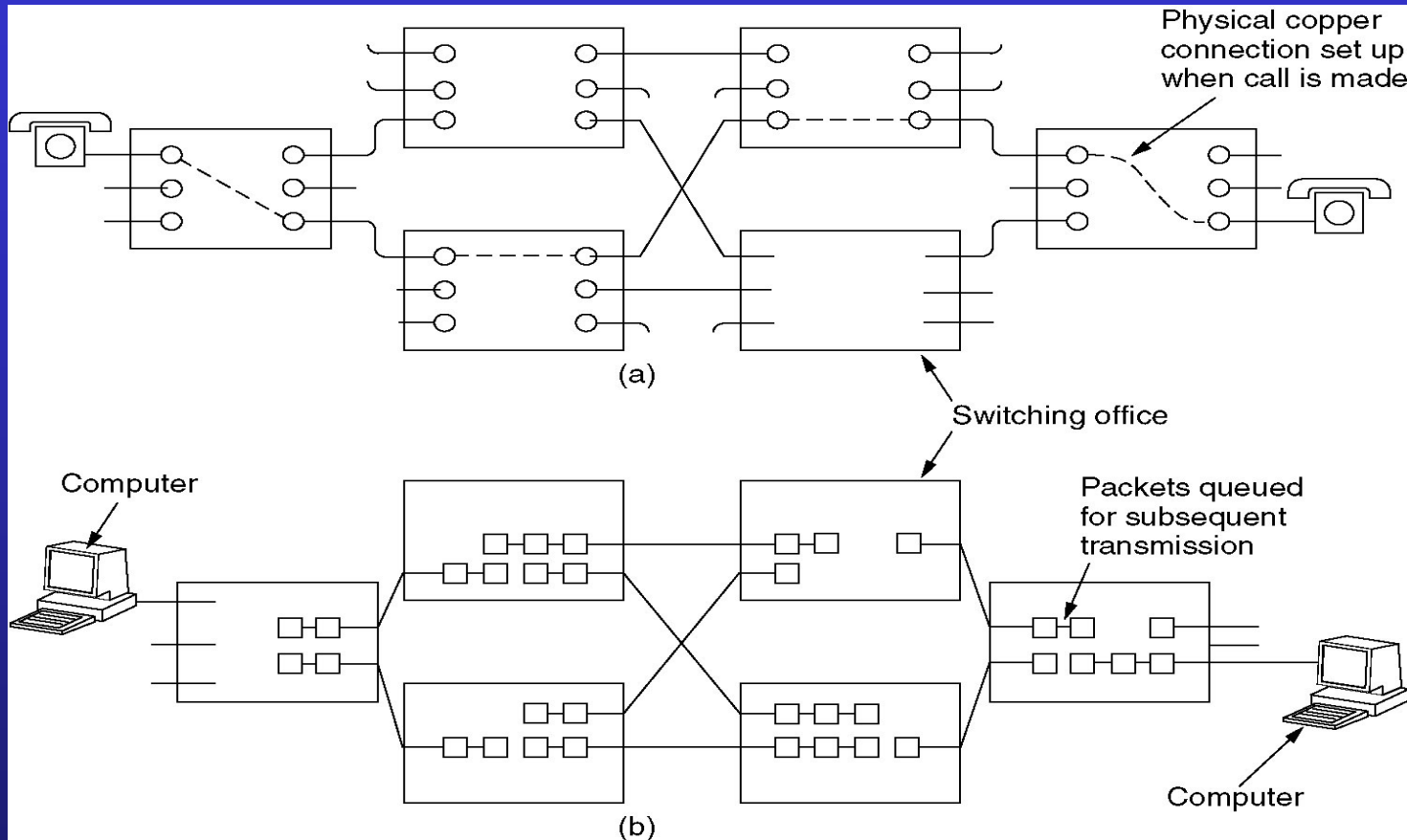

Figure 2-38. (a) Circuit switching. (b) Packet switching.

Store-and-Forward Networks

- Intermediate processors (IMPS, nodes, routers, gateways, switches) along the path store the incoming block of data.
- Each block is received in its entirety, inspected for errors, and retransmitted along the path to the destination. This implies buffering at the router and one transmission time per hop.



Message Switching

- A store-and-forward network where the block of transfer is a complete *message*.
- Since messages can be quite large, this can cause:
 - buffering problems
 - high mean delay times



Packet Switching

- A store-and-forward network where the block of transfer is a complete *packet*. A packet is a variable length block of data with a tight upper bound.

⇒ Using packets improves mean message delay.



Cell Switching

53 bytes

- A network where the unit of transfer is a small, fixed-size block of data (i.e., one cell).
- ATM (Asynchronous Transfer Mode) networks use 53-byte cells.

Packet Switched Networks

Connection-oriented Protocols

- A setup stage is used to determine the end-to-end path before a connection is established.
- Data flow streams are identified by some type of connection indicator (e.g. OSI, X.25, SNA).



Connection-Oriented Concatenation of Virtual Circuits

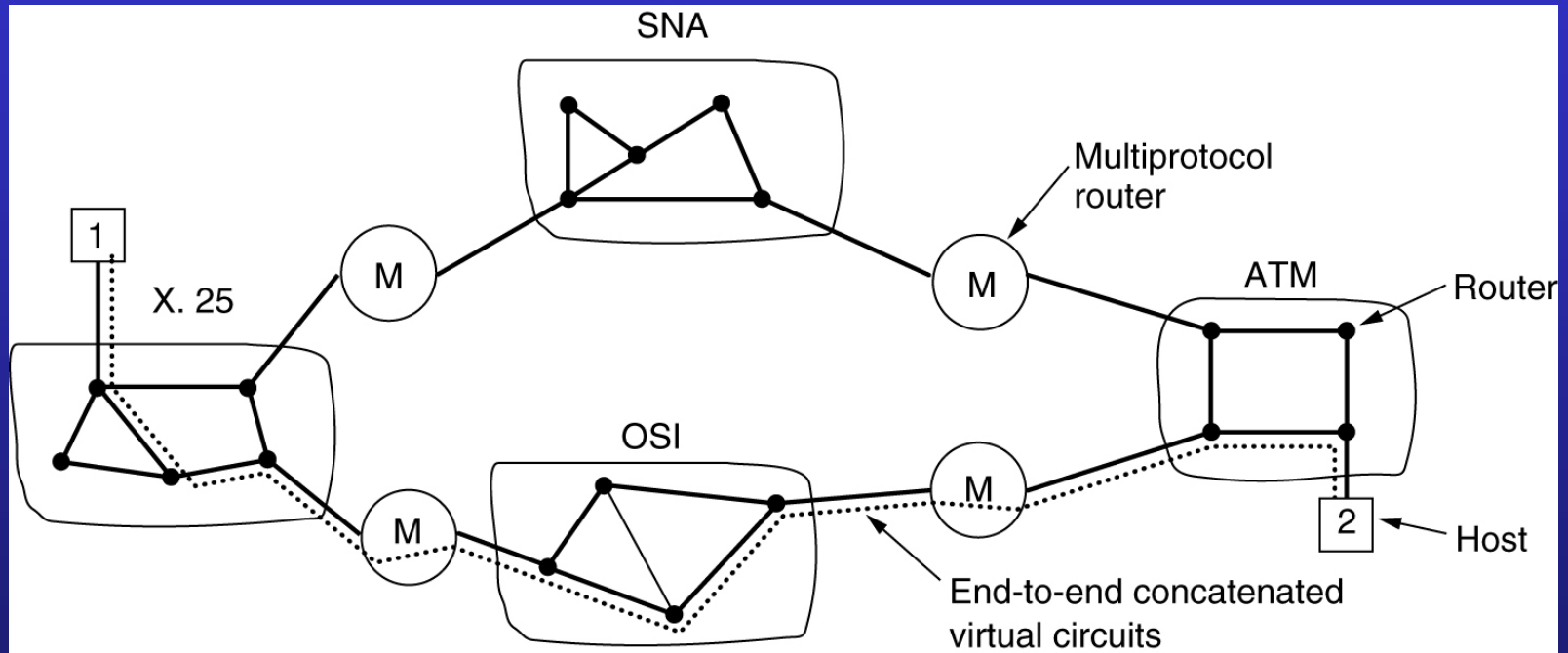

Figure 5-45. Internetworking using concatenated virtual circuits.

Packet Switched Networks

Connectionless Protocols

- No set up is needed.
- Each packet contains information which allows the packet to be individually routed hop-by-hop through the network.



Connectionless Internetworking

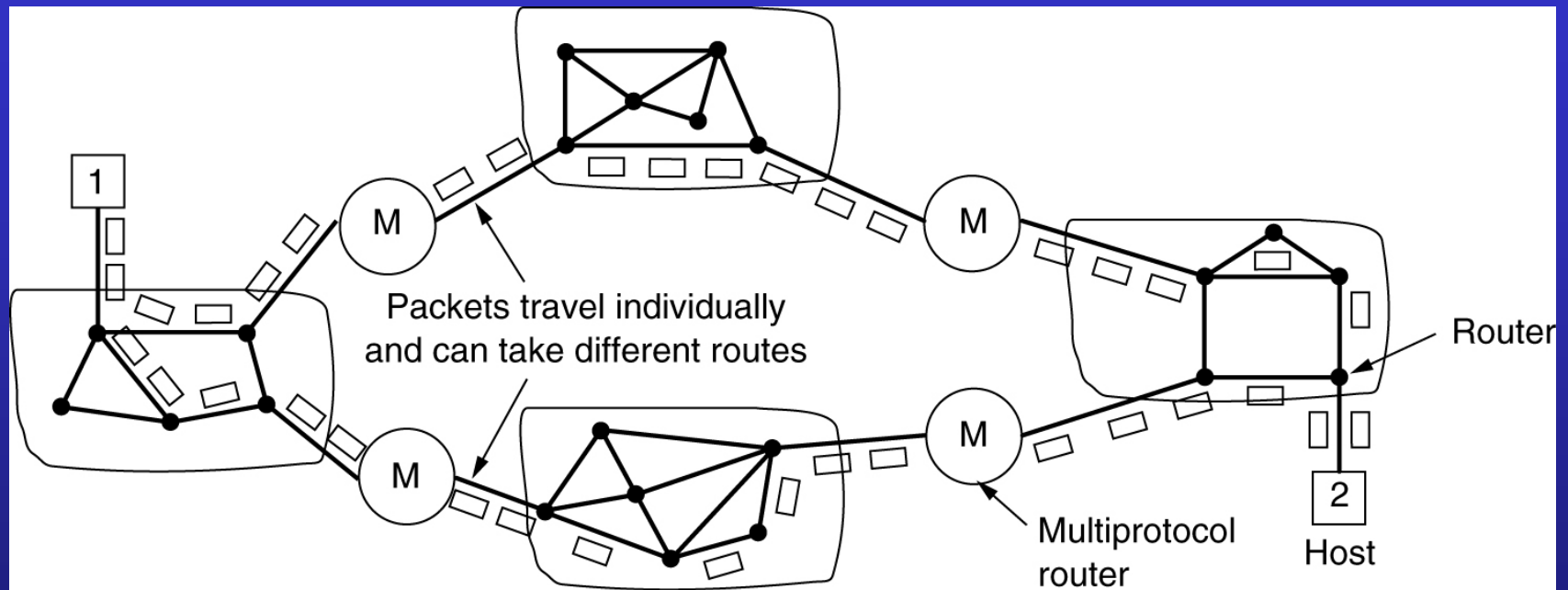

Figure 5-46. A connectionless internet.

Datagram vs Virtual Circuit

Datagram

- Each datagram packet may be individually routed.

Virtual Circuit

- Virtual circuit set up is required.
- All packets in a virtual circuit follow the same path.



Event Timing

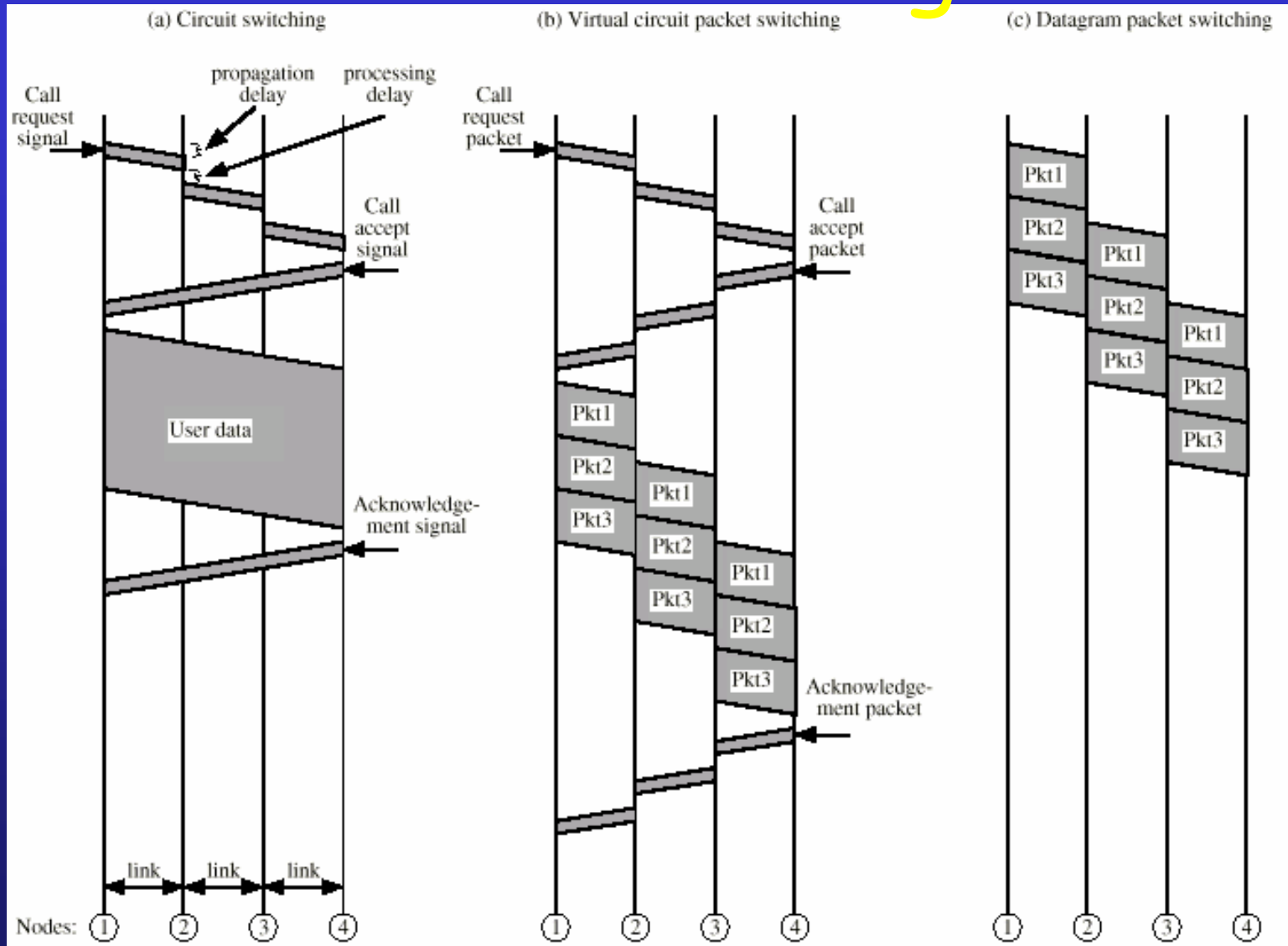

DCC 6th Ed., W. Stallings, Figure 10.3

Networks: Switching

External Virtual Circuit And Datagram Operation

DCC 6th Ed.,
W. Stallings,
Figure 10.4

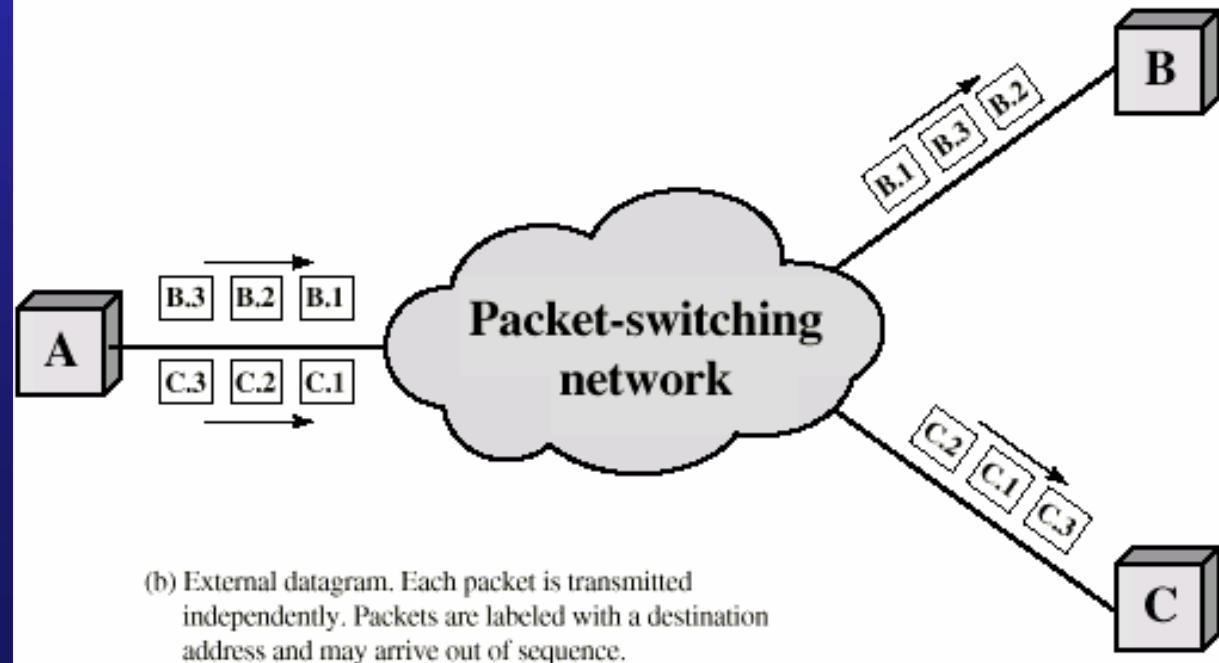
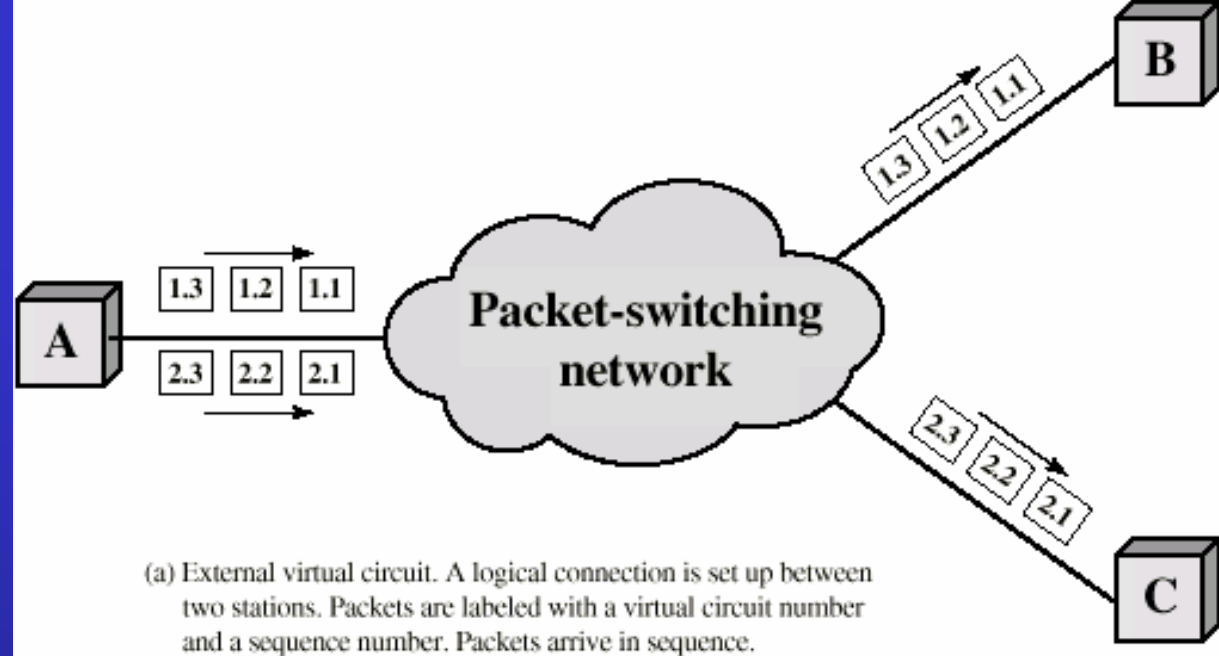

Internal Virtual Circuit And Datagram Operation

DCC 6th Ed.,
W. Stallings,
Figure 10.5

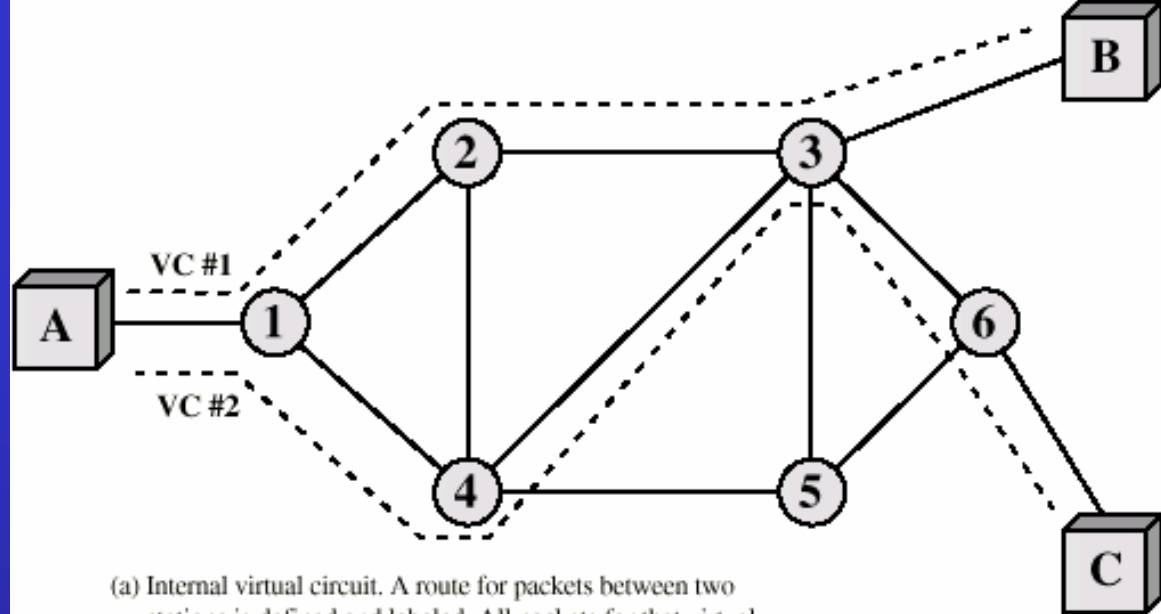

(a) Internal virtual circuit. A route for packets between two stations is defined and labeled. All packets for that virtual circuit follow the same route and arrive in the same sequence.

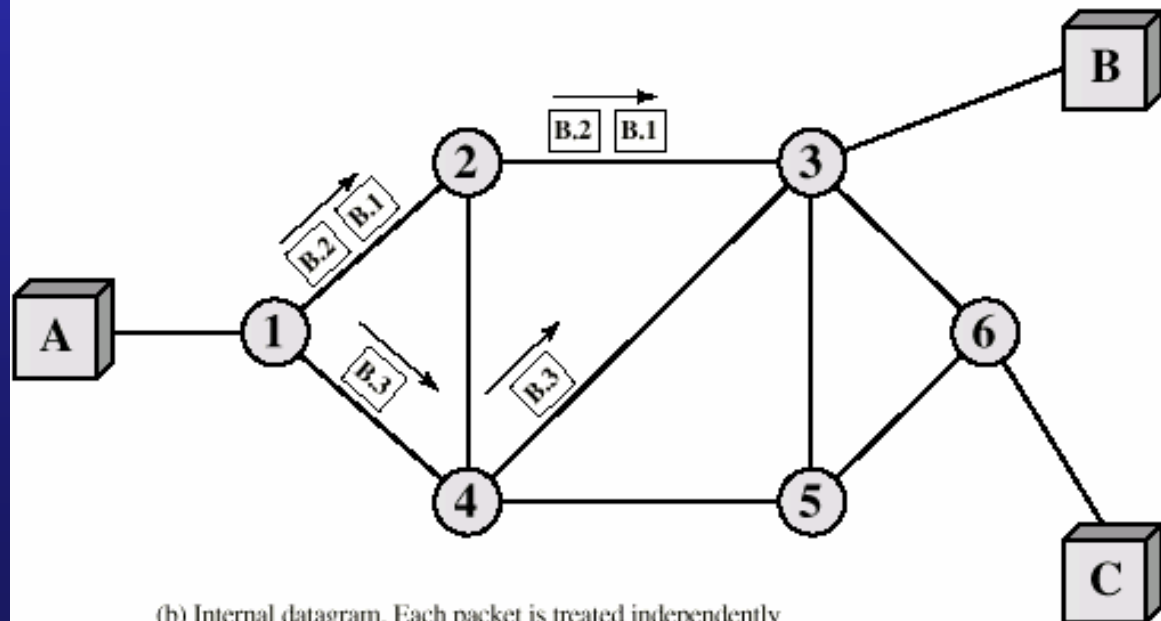

(b) Internal datagram. Each packet is treated independently by the network. Packets are labeled with a destination address and may arrive at the destination node out of sequence.