

# CS4514

# Computer Networks

Term B08

Professor Bob Kinicki



# Course Objectives



# Course Objectives

1. To develop an understanding of modern network architectures from a **design** and **performance** perspective.
2. To introduce the student to the major concepts involved in wide-area networks (WANs), local area networks (LANs), Wireless LANs (WLANs) and Wireless Sensor Networks (WSNs).
3. To clarify network terminology.



# Course Objectives

4. To provide an opportunity to do network programming using **TCP/IP**.
5. To give the students experience working in programming teams.
6. To provide a WLAN performance evaluation experience.
7. To expose students to emerging technologies and their potential impact.



# Introduction



# *Network Definitions and Classification*

- Preliminary definitions and network terminology
- Sample application paradigms
- Classifying networks by transmission technology
- Classifying networks by size (or scale)
- Classifying networks by topology



# Preliminary Definitions

**computer network** :: [Tanenbaum] a collection of “autonomous” computers interconnected by a single technology.

[LG&W] *communications network* :: a set of equipment and facilities that provide a service.

In a **distributed system** the collection of independent computers appears to its users as a single coherent system.



# Client-Server Applications

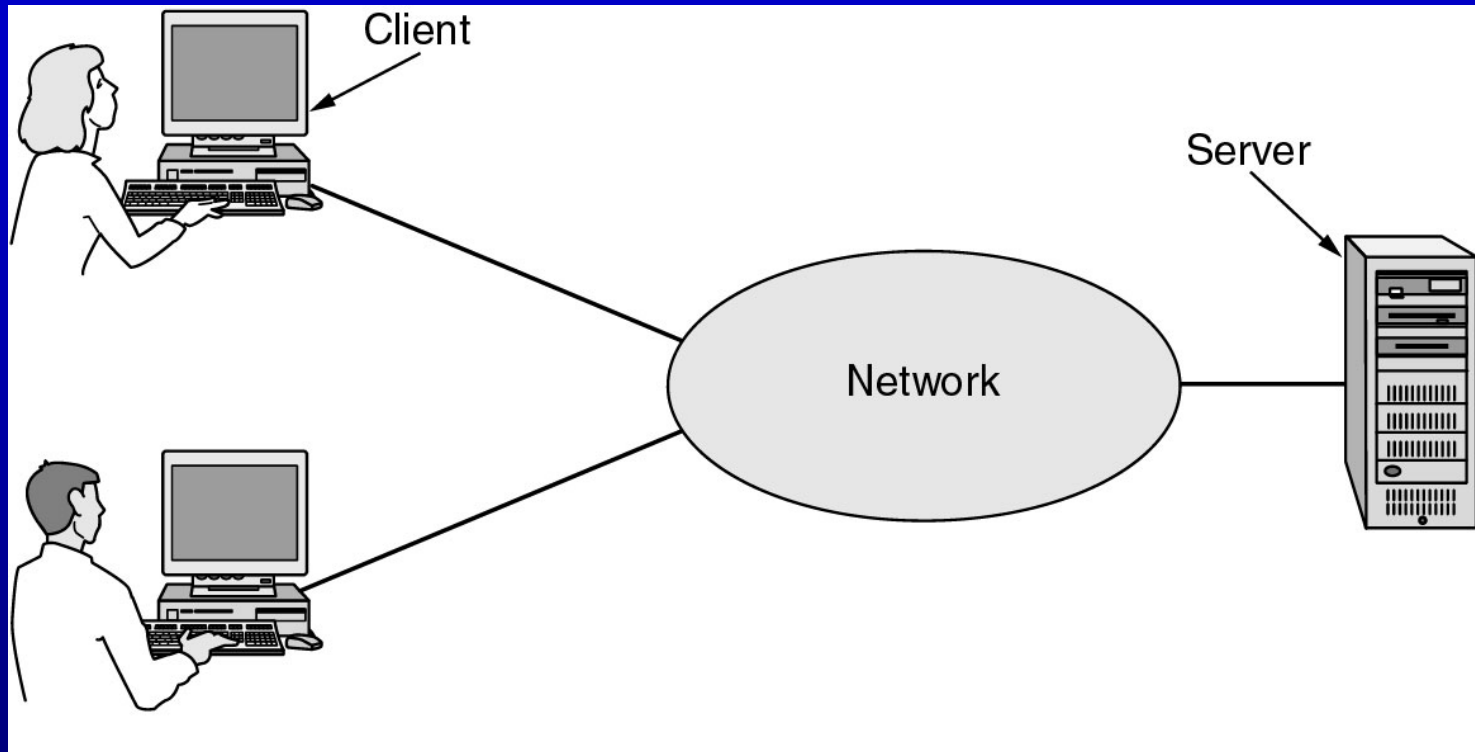

Figure 1.1 A network with two clients and one server.



# Client-Server Model

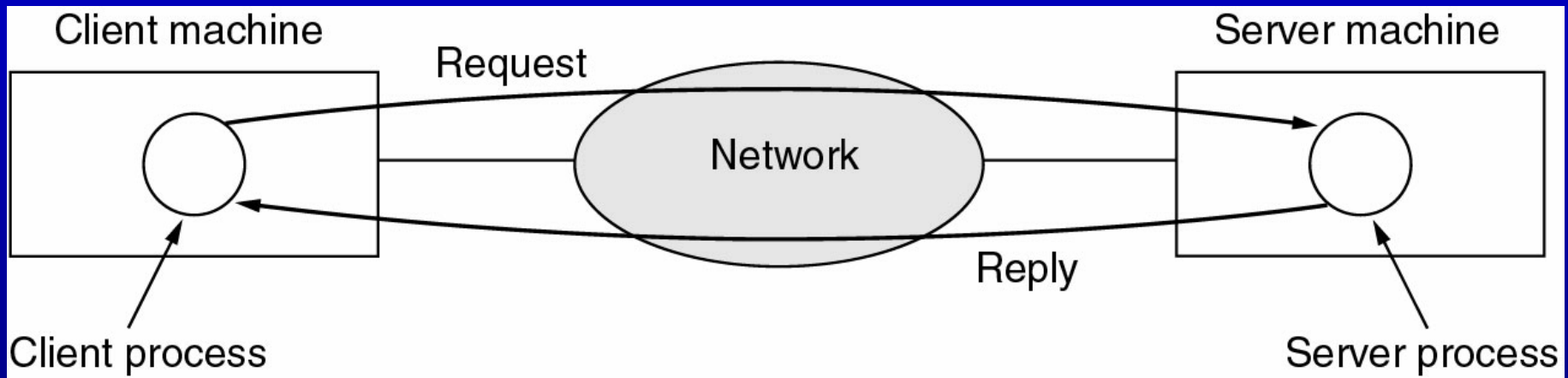

Figure 1-2. The client-server model involves requests and replies.

# Peer-to-Peer Applications

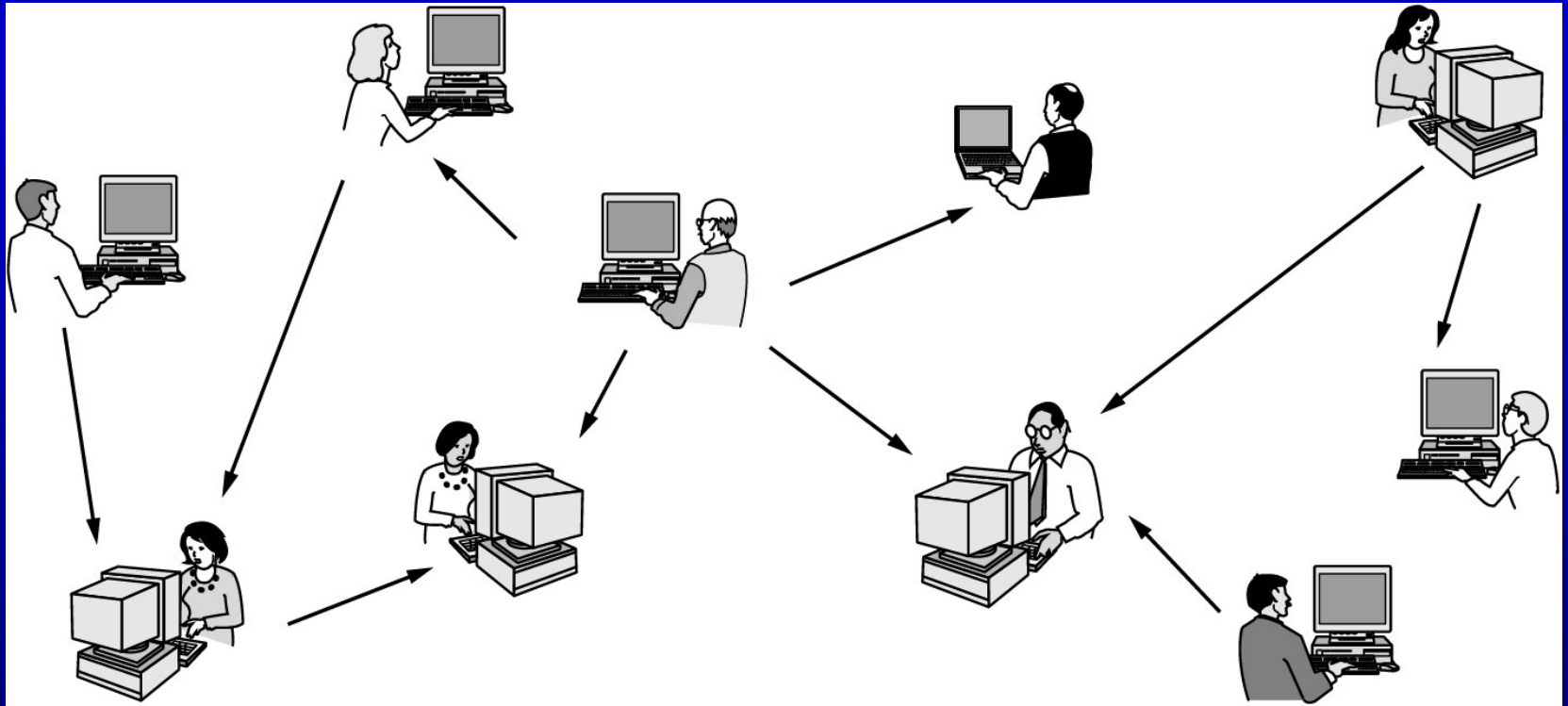
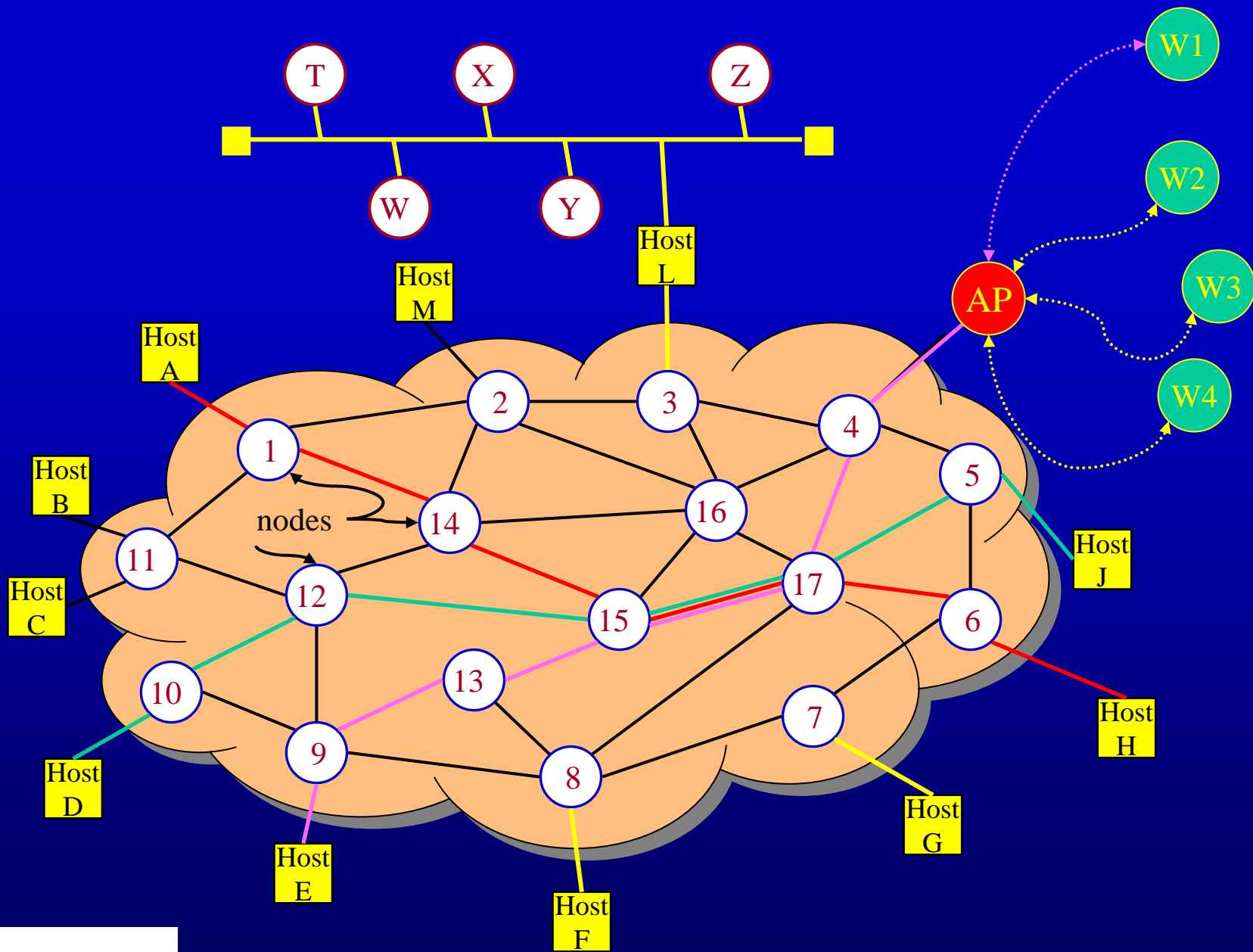

Figure 1.3 In a peer-to-peer system there are no fixed clients and servers.

# Mobile Network Users

Wireless	Mobile	Applications
No	No	Desktop computers in offices
No	Yes	A notebook computer used in a hotel room
Yes	No	Networks in older, unwired buildings
Yes	Yes	Portable office; PDA for store inventory

Figure 1-5. Combinations of wireless networks and mobile computing.



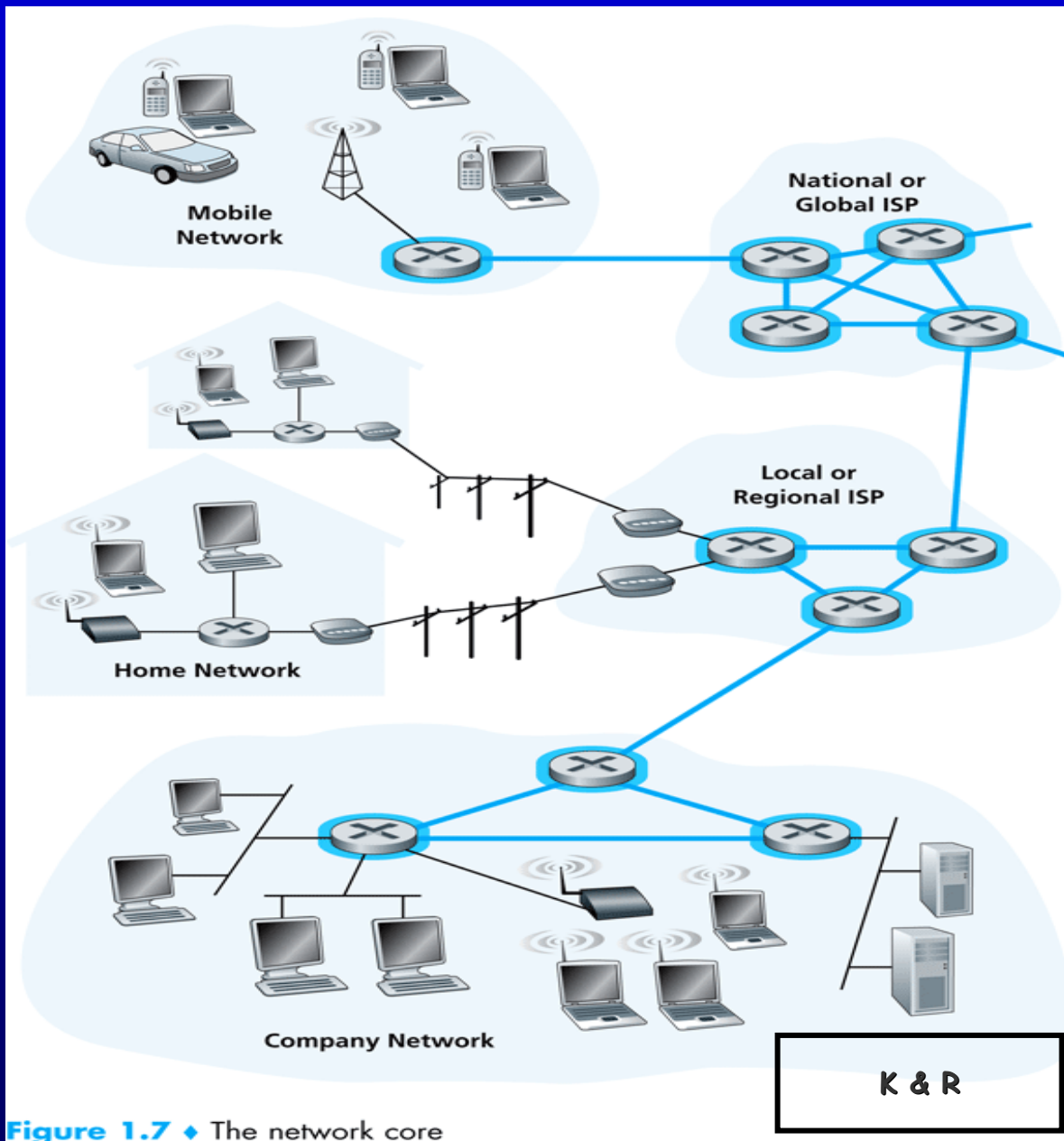

Figure 1.7 ♦ The network core

# Classifying Networks by Transmission Technology

**broadcast** :: a single communications channel shared by all machines (addresses) on the network. *Broadcast can be both a logical or a physical concept (e.g. Media Access Control (MAC) sublayer).*

**multicast** :: communications to a specified group. *This requires a group address (e.g. – multimedia multicast).*

**unicast** :: a communication involving a single sender and a single receiver.

**point-to-point** :: connections made via *links* between pairs of nodes.



# Network Classification by Size

Interprocessor distance	Processors located in same	Example
1 m	Square meter	Personal area network
10 m	Room	
100 m	Building	
1 km	Campus	
10 km	City	Local area network
100 km	Country	Metropolitan area network
1000 km	Continent	
10,000 km	Planet	Wide area network
		The Internet

Figure 1-6. Classification of interconnected processors by scale.

# Network Classification by Size

- **LANs** {Local Area Networks}
  - Wired LANs: typically physically broadcast at the MAC layer (e.g., Ethernet, Token Ring)
  - Wireless LANs (WLANs)
  - Wireless Sensor Networks (WSNs)
- **MANs** {Metropolitan Area Networks}
  - campus networks connecting LANs logically or physically.
  - often have a backbone (e.g., FDDI and ATM)





# Wired LANs

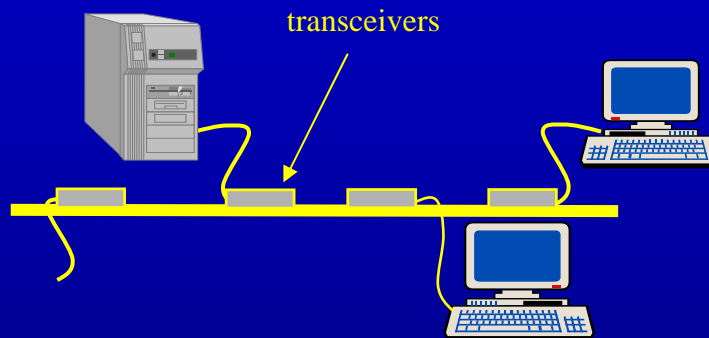

Ethernet bus

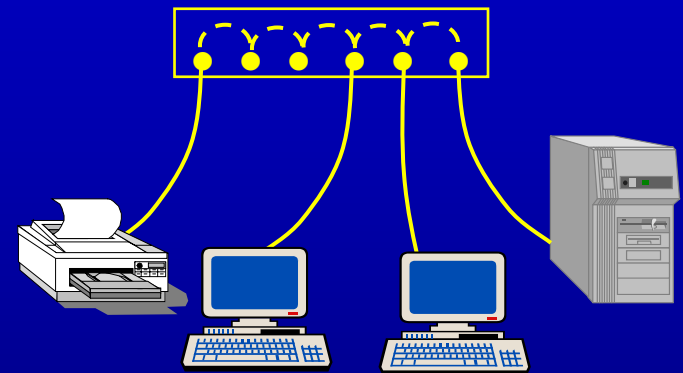

Ethernet hub

Copyright ©2000 The McGraw Hill  
Companies

Leon-Garcia & Widjaja: *Communication  
Networks*

Figure 1.17

# Wireless LANs (WLANs)

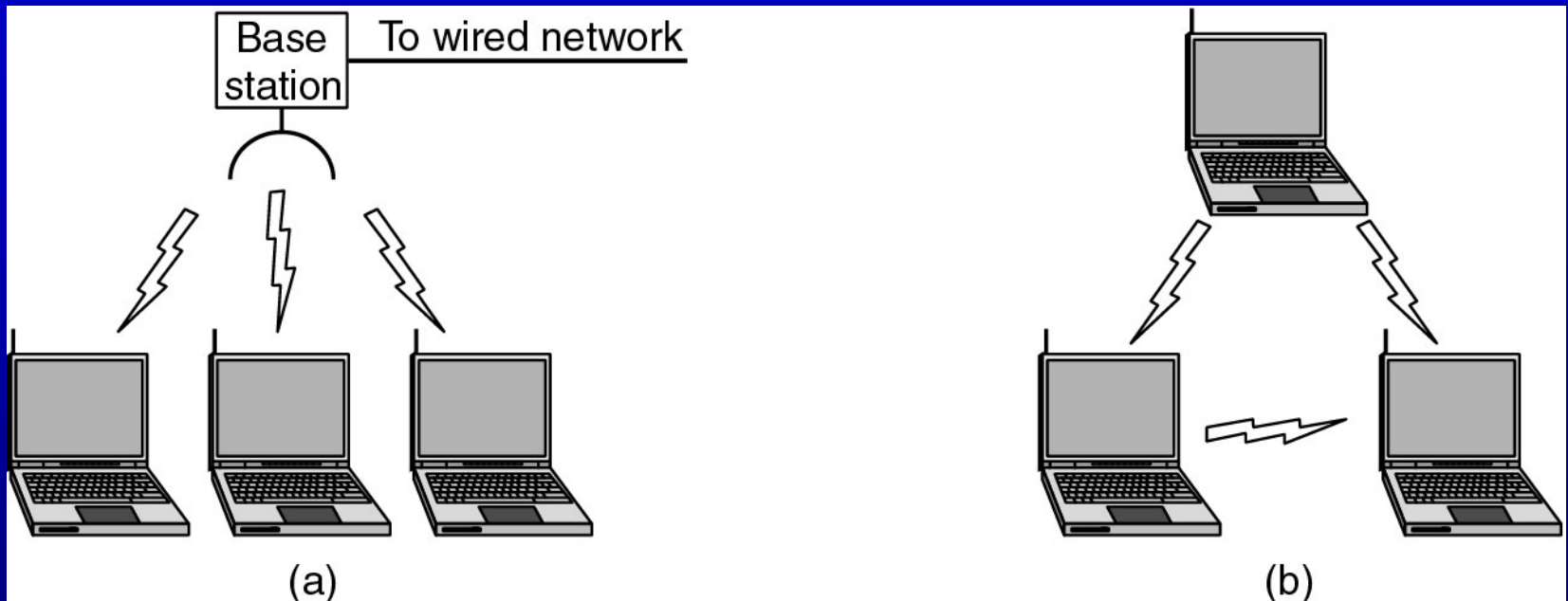

Figure 1-35. (a) Wireless networking with a base station. (b) Ad hoc networking.

# Metropolitan Area Networks

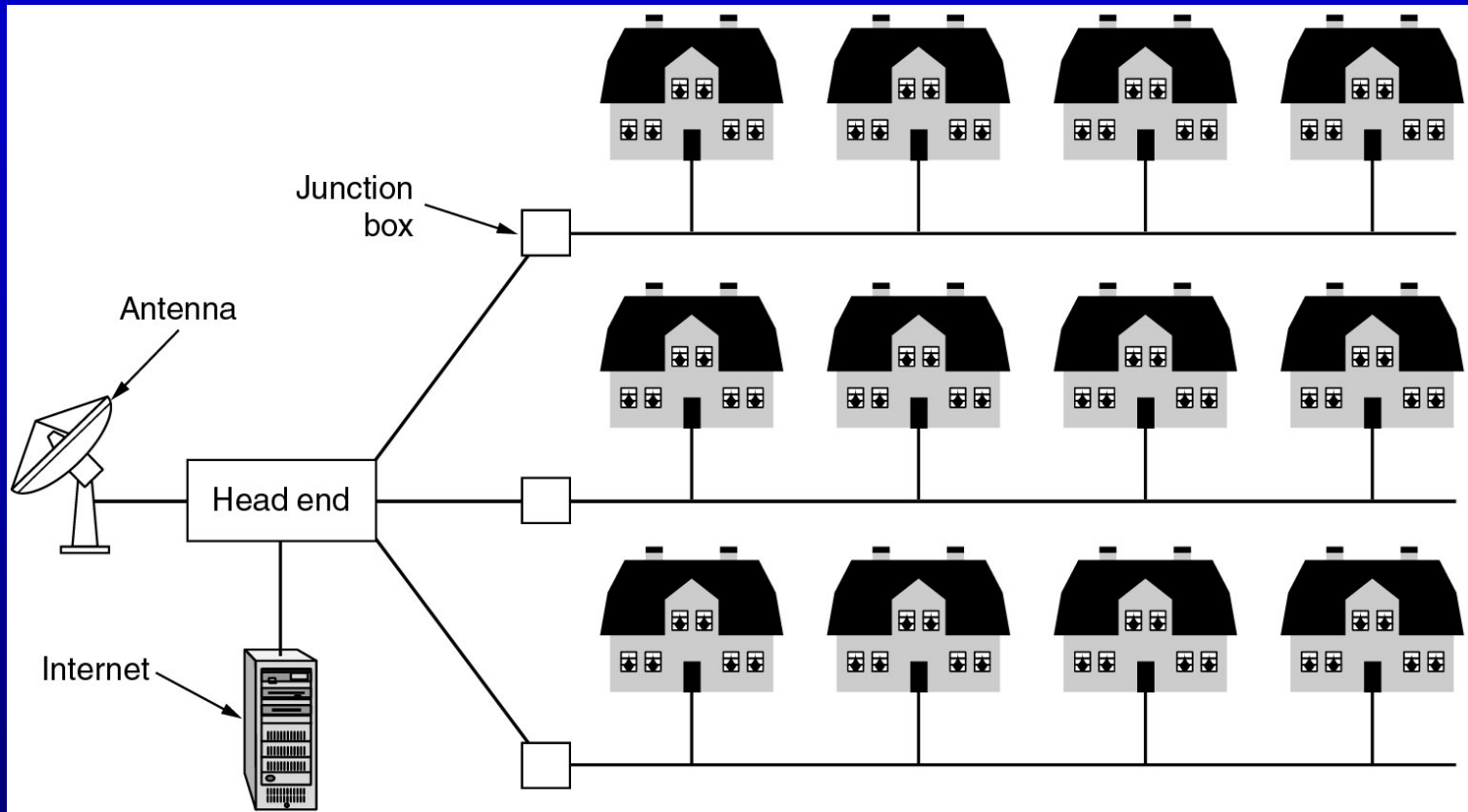
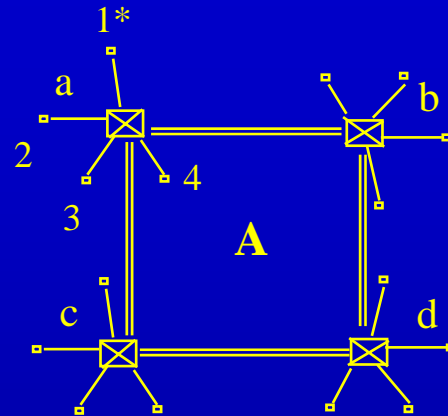

Figure 1-8. A metropolitan area network based on cable TV.

# MAN



Metropolitan network **A** consists of access subnetworks a, b, c, d.

## Hierarchical Network Topology

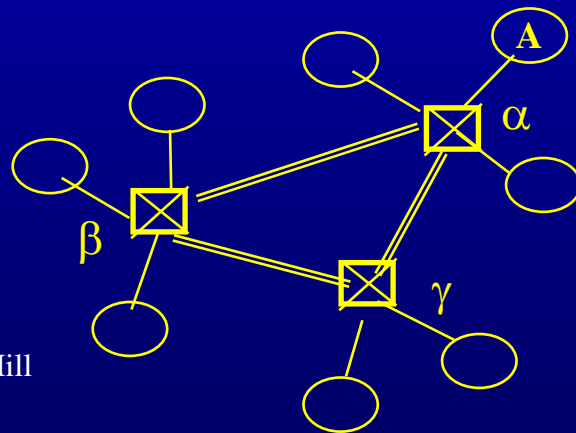

National network consists of regional subnetworks  $\alpha$ ,  $\beta$ ,  $\gamma$ .

Metropolitan network **A** is part of regional subnetwork  $\alpha$ .

Copyright ©2000 The McGraw Hill Companies

Leon-Garcia & Widjaja: *Communication Networks*

Figure 1.8

# Network Classification by Size

- **WANs** { Wide Area Networks }
  - *also referred to as “point-to-point” networks.*
  - ARPANET → Internet
  - usually hierarchical with a backbone.
  - Enterprise Networks, Autonomous Systems
  - VPNs (Virtual Private Networks).



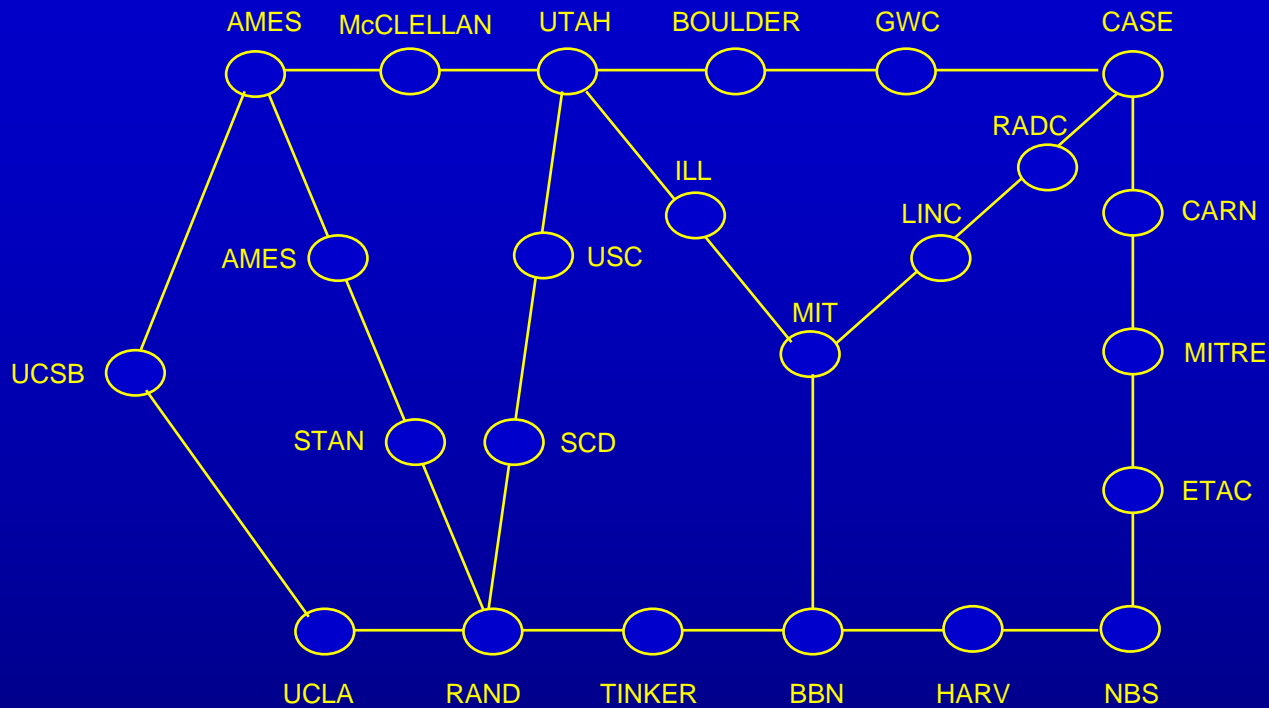

ARPANet circa 1972  
*a point-to-point network*

Copyright ©2000 The McGraw Hill Companies

Leon-Garcia & Widjaja: *Communication Networks*

Figure 1.16



# Wide Area Networks (WANs)

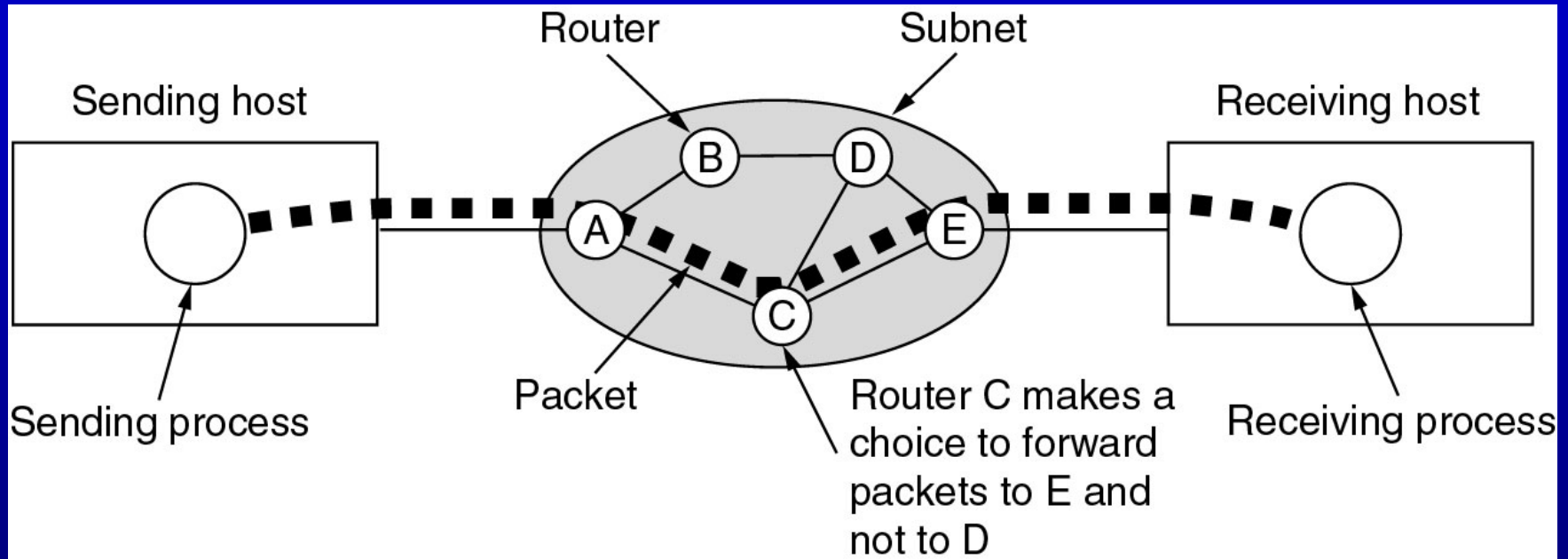
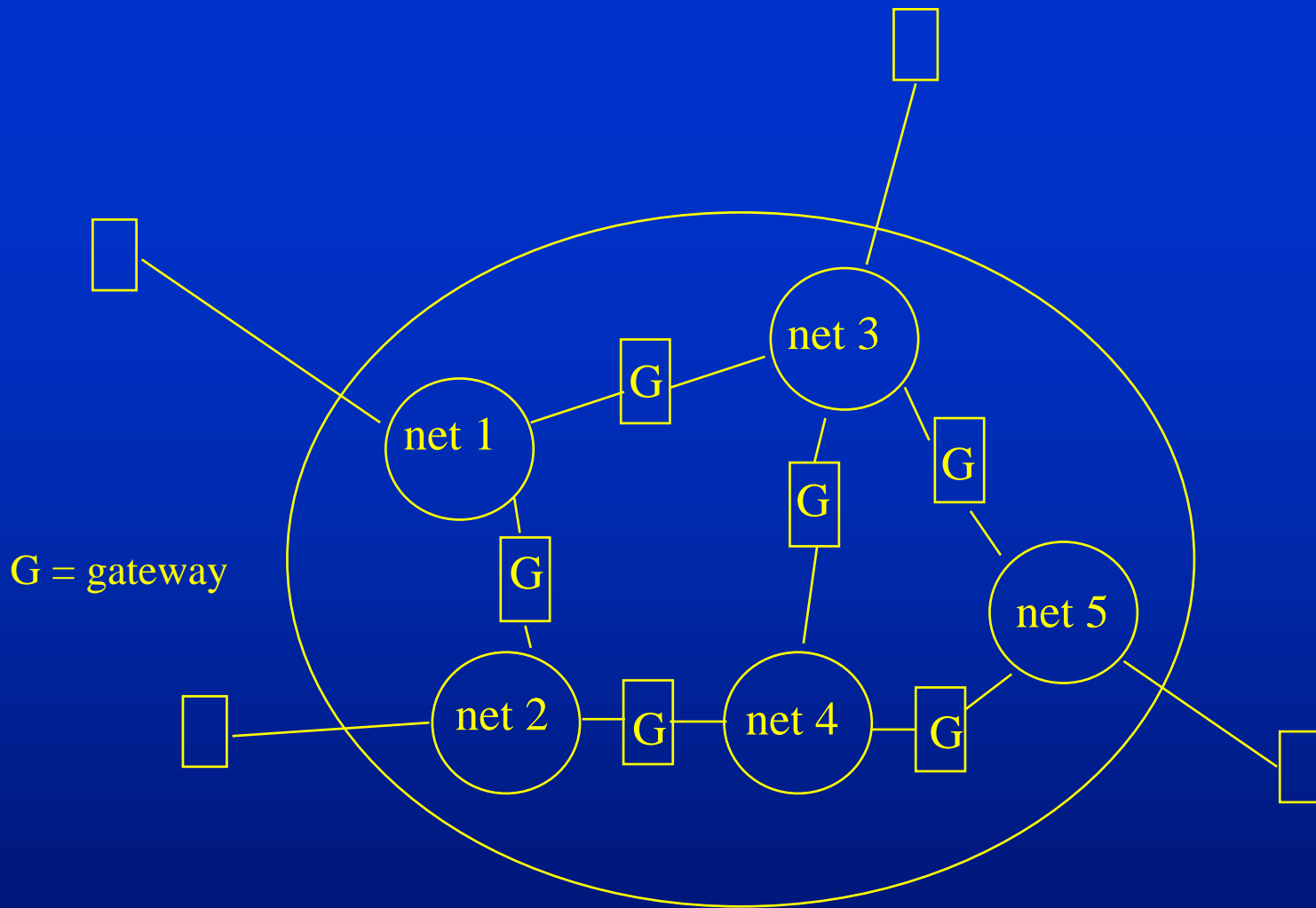

Figure 1-10. A stream of packets from sender to receiver.



**internet - a network of networks**

Copyright ©2000 The McGraw Hill Companies

Leon-Garcia & Widjaja: *Communication Networks*

Figure 1.18





# Network Classification by Topology

## Bus

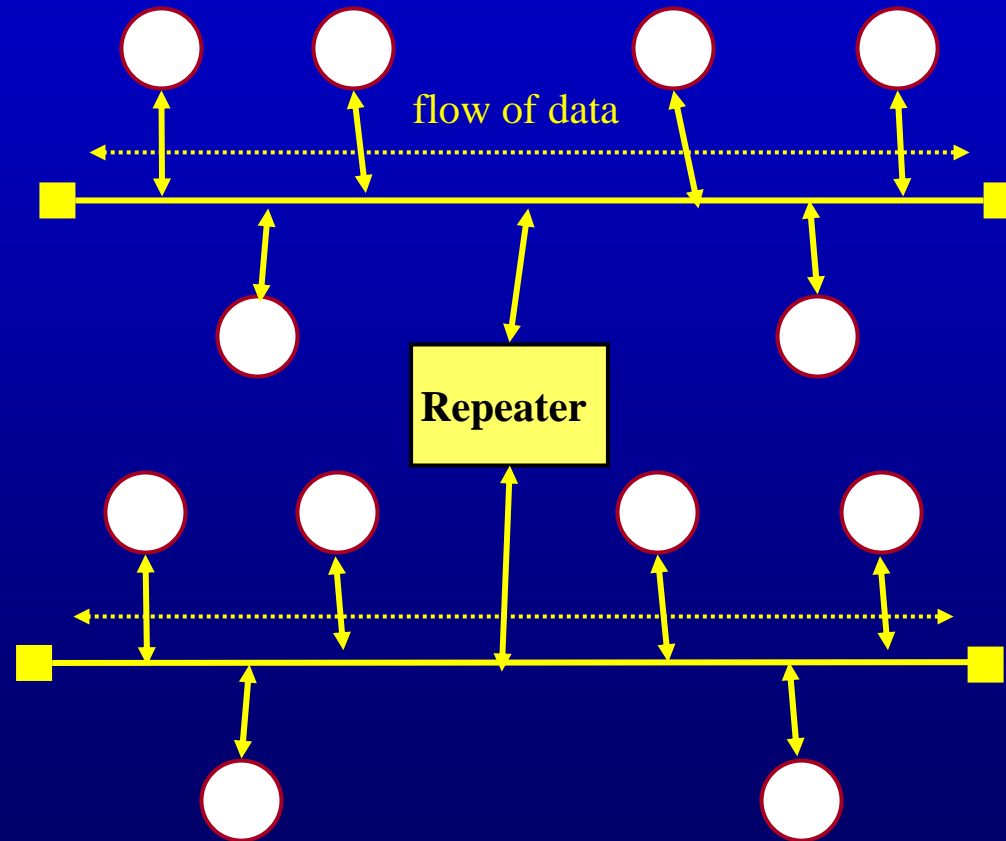

*Bidirectional flow  
assumes baseband cable*

# Network Classification by Topology

## Ring

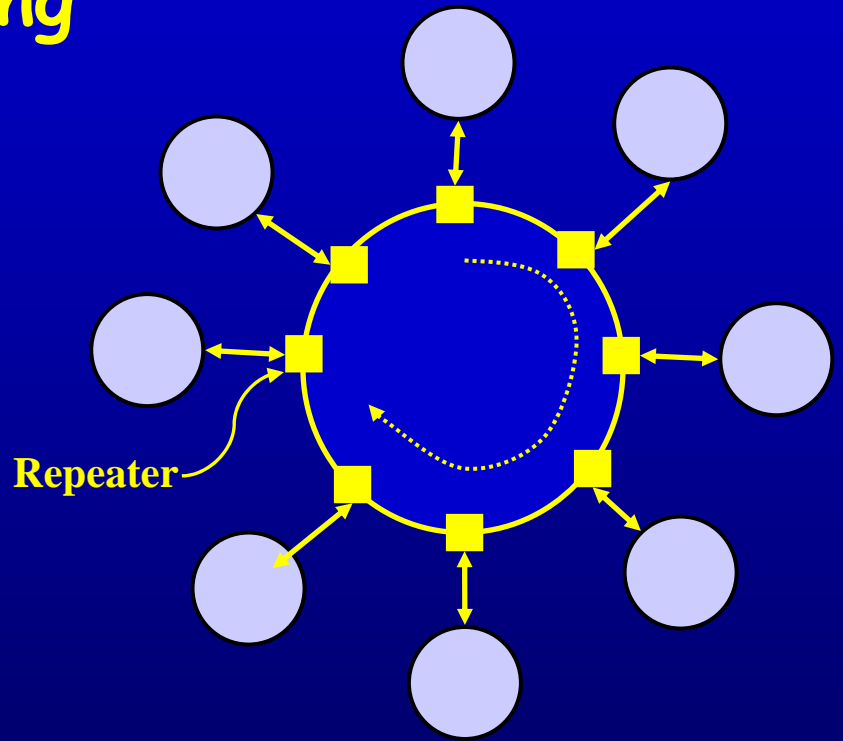
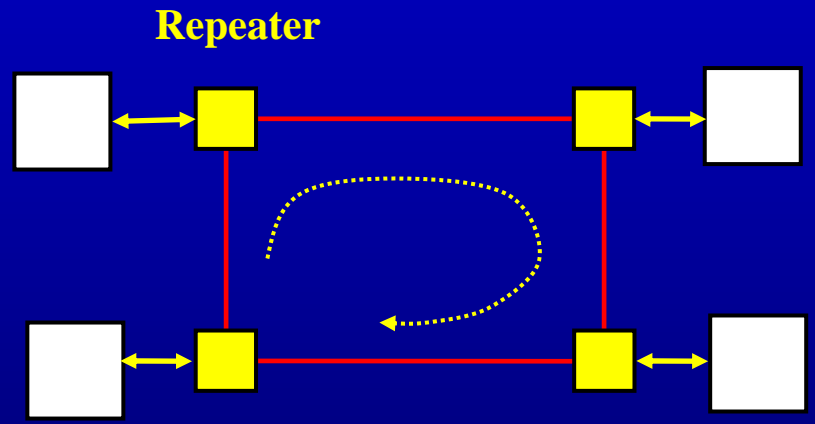

Note - a ring implies unidirectional flow

# Network Classification by Topology

## Tree

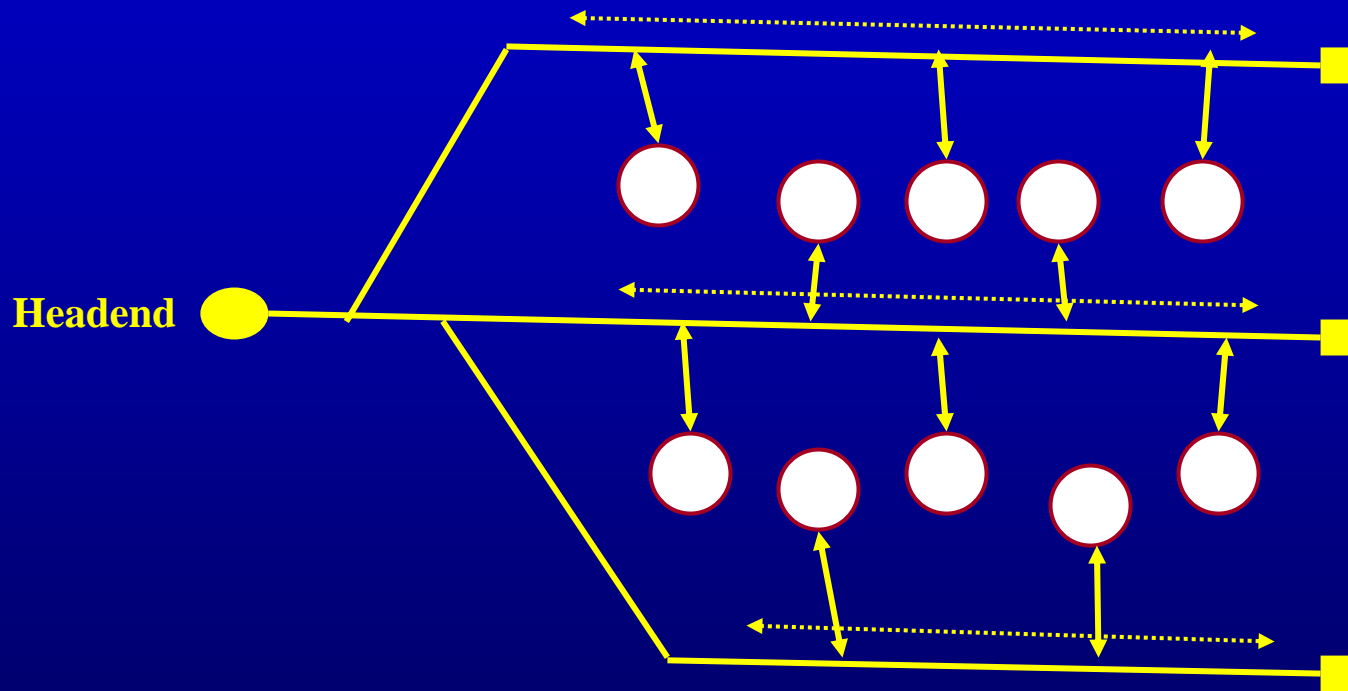

# Network Classification by Topology

## Star

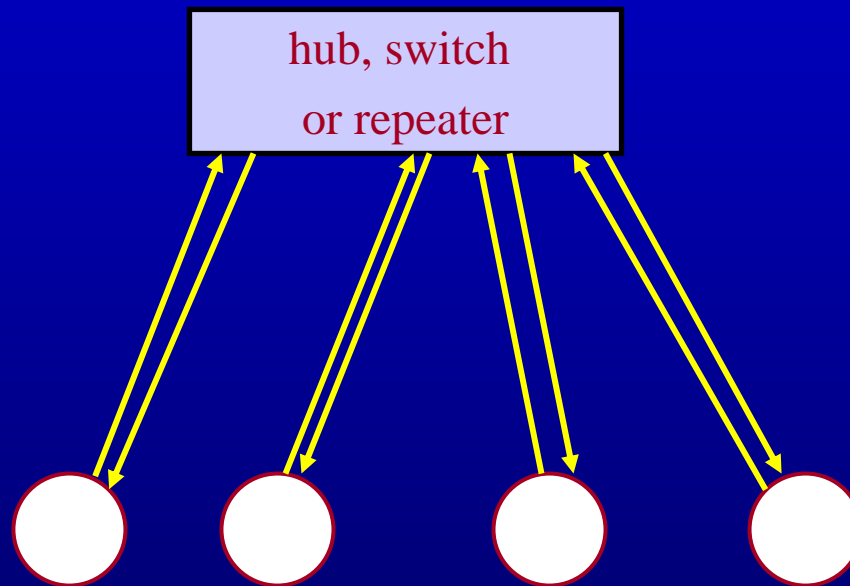

# Network Classification by Topology

## Star

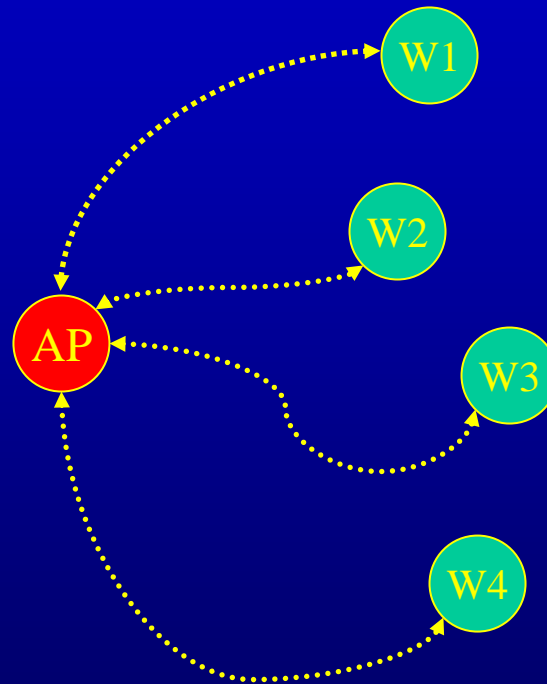

Wireless Infrastructure